

FlavourSpec[®]25 with PAL3-RSI



User Manual



G.A.S. Gesellschaft für
analytische Sensorsysteme mbH

FlavourSpec®25– User Manual

Version 4.80, September 2025

Valid from FlavourSpec® 25 Firmware Version 4.80 in combination with Autosampler PAL3 RSI Series II

All data, texts, designs, images and other elements used in this user manual are protected by copyright law. Any infringement may be subject to legal action.

Passing it on to third parties and producing copies of any kind or form – on the whole or in parts - is not permitted without written agreement of G.A.S. Any infringement may be subject to legal action.

G.A.S. reserves the right to realize technical changes to the product without explicitly mentioning them.

CE-Marking according to:

International Standard EN ISO 17050-1:2004

European Union Low Voltage Directive 2006/95/EC

European Union Electromagnetic Compatibility Directive 2004/108/EC

© Copyright 2025

**G.A.S. Gesellschaft für analytische Sensorsysteme mbH
44227 Dortmund - Germany**

All Rights Reserved.

**G.A.S. Gesellschaft für analytische Sensorsysteme mbH
Otto-Hahn-Str. 15
D-44227 Dortmund
Germany**

**Phone: (+49) 231/9742-6550
Fax.: (+49) 231/9742-6555
E-Mail: support@gas-dortmund.de
Internet: www.gas-dortmund.de**

Table of Content

1	General Information	7
1.1	Information about the Manual	7
1.2	Explanation of symbols	7
1.3	Notation for dialogs, elements and references.....	8
1.4	Scope of Supply.....	9
1.5	Liability and Guarantee	15
1.6	Copyright	16
1.7	Return and Disposal	16
1.8	Software Updates	16
1.9	Customer Service	16
2	Safety	17
2.1	Intended Use Only	17
2.2	Responsibility of Operator.....	17
2.3	Requirements of Personnel	17
2.4	Dangers	18
3	Transport, Packing and Storage.....	20
3.1	Inspection after Transport.....	20
3.2	Packing	20
3.3	Storage and Transport.....	20
4	Cleaning and Maintenance	21
4.1	Cleaning.....	21
4.2	Maintenance	21
5	Introduction	22
5.1	Working principle of IMS technology.....	22
5.2	Purpose of the device	28
5.3	Principle setup and internal gasflow.....	29
5.4	Housing Device Versions.....	31
5.5	Device Type / Serial Number Plate.....	33
6	Operating Interface.....	34
6.1	Overview	35
6.2	Spectra Window.....	40
6.3	Sequence Window	48

FlavourSpec®25– User Manual

6.4	Defaults Window	50
6.5	Programs Window.....	53
6.6	System Window	62
6.7	Error Information Window	86
6.8	Additional Dialog Windows	87
6.9	PAL3 RSI Autosampler-Terminal.....	92
6.10	Remote control of the PAL3 RSI with the PAL Control software.....	93
7	Installation	94
7.1	Installation Requirements	94
7.2	Unpack the device	96
7.3	Unpack the accessories.....	99
7.4	Mount the Safety guard.....	101
7.5	Connect the PAL3 RSI Terminal.....	102
7.6	Check the Preinstalled Connection Cable.....	103
7.7	Connect the Gas Supply	104
7.8	Connect the Power Supply	108
7.9	Remove the Transport lock.....	110
7.10	Complete the Device.....	111
7.11	Switch on the Device	111
7.12	Check essential device position.....	113
7.13	Warm-up phase after device powering-on	114
7.14	Prepare the device for operation.....	115
8	System Operation (How to...)	119
8.1	Measurement Requirements.....	119
8.2	Adjusting the gas type settings	120
8.3	Select Measurement Program	122
8.4	Create a Measurement Program	123
8.5	Check Injector Position	126
8.6	Teach Injector Position	129
8.7	Check Agitator Position.....	135
8.8	Teach Agitator Position.....	139
8.9	Check Tray Reference Position	145
8.10	Teach Tray Reference Position	149
8.11	Create a New Job	155
8.12	Edit a Job.....	160

8.13	Create a New Method	162
8.14	Edit a Method.....	166
8.15	Run a measurement with autosampler	168
8.16	Run a measurement with manual injection	173
8.17	Setting the injection counter.....	176
8.18	Change Septum.....	177
8.19	Change syringe.....	180
8.20	Creating and Copying a PAL3 RSI Backup file	190
8.21	Start Sequence	193
8.22	File Transfer Setup	194
8.23	Start Cleaning mode	202
8.24	Start Standby mode	204
8.25	Remove the Housing Cover	205
8.26	Change Capillary Column	207
8.27	Change high voltage circuit board.....	212
8.28	Firmware Upgrade	217
8.29	Creating diagnostic information for support	220
8.30	Packing FlavourSpec® for return transport.....	222
8.31	Packing FlavourSpec® with PAL3 RSI for return transport.....	224
8.32	Manual modification of the sample description attribute.	227
8.33	Switching the screen interface from English to Chinese	228
9	Appendix	232
9.1	Technical data: FlavourSpec®.....	232
9.2	Technical data: PAL 3 RSI Series II.....	234
9.3	Technical data: I/O Interface	235
9.4	Ionisation Source Specification	237
9.5	Technical drawing: Internal Gasflow	238
9.6	PAL LED Status LED	239
9.7	LED Status at PAL Control PCB	239
9.8	FlavourSpec® Defaults – Parameter	240
9.9	FlavourSpec® Program parameter	241
9.10	PAL RSI Headspace Methods parameter	241
9.11	PAL RSI ITEX Methods parameter	242
9.12	PAL RSI Job parameter	244
9.13	Troubleshooting	244

FlavourSpec®25– User Manual

9.14 Consumables / Spare Parts 257

9.15 G.A.S. Documents and Tutorials 263

9.16 Table of Figures 264

1 General Information

1.1 Information about the Manual

This manual describes a safe and adequate handling of the device. Following the instructions of the indicated safety aspects and instructions as well as the national and/or local rules and general safety regulations concerning the prevention of accidents are absolutely imperative.

Before starting the work with the device read the manual completely and thoroughly particularly the chapter security and respective safety references. Assure that you/the operator comprehend the terms described.

The manual is part of the device. It must be stored together with and next to the device at any time.

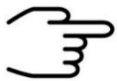

INFORMATION

The graphics in this user manual are schematic and may differ from the actual conditions. The firmware and PC software screenshots in this user manual may differ from the actual conditions.

1.2 Explanation of symbols

Important and safety-relevant references in this manual are labeled with symbols. These indications which are in-line with industrial safety must be respected and followed at any time.

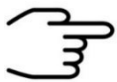

INFORMATION

This symbol calls information, which are to be considered for efficient and perfect handling of the equipment.



WARNING

This symbol indicates references, which can lead to damages, malfunctioning and/or loss of the device.



DANGER

This symbol marks references, which can lead to health impairments, injuries, lasting body damages or to death due to electric current.



DANGER

This Symbol marks paragraphs, which describe potential dangers and damage due to exposure to radioactive radiation.



DANGER

This symbol marks paragraphs, which describe situations in which surface parts of the device can heat up to a point where touching it or bringing objects close to it may be hazardous.

1.3 Notation for dialogs, elements and references

Example Dialog:

System > **Connections** > **LAN File Transfer** > **Settings...** > **Test Connection**

Example Elements:

Gas Out, **Sample In**

Example: References

Advanced User Manual, **Chapter 5.1 Installation Requirements**

Example: Information

keep the transport box

1.4 Scope of Supply

Assure that you have received the full scope of supply. If there is any part missing, please contact the GAS-hotline immediately.

FlavourSpec® Scope of Supply



FlavourSpec® device coupled with Autosampler PAL3 RSI Series II



FlavourSpec® Power Supply with cable (1 piece)



FlavourSpec® Gas tube Kit

- Drift gas/carrier gas adapter (1 piece)
- 2 m 3 mm PFA Tubes with 3 mm Swagelok-Connector (2 Pieces)
- 0.65 m 3 mm PFA Tubes with 3 mm Swagelok-Connector (1 Pieces)

FlavourSpec®25– User Manual



Molecular sieve 200 mL with 1/8" connections (1 piece) with holder (different designs)



LAN Cable (1 piece)



FlavourSpec®-PAL3 RSI Series II
Connection Cable (1 piece)

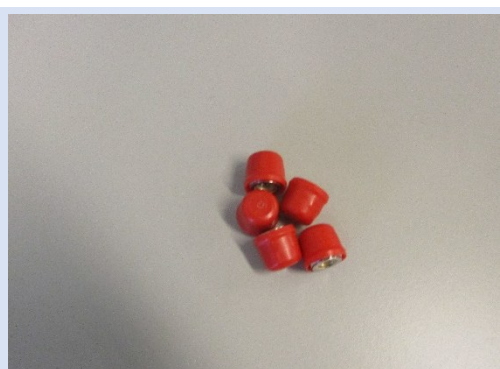

FlavourSpec® Blind plug Set (4 pieces)
(Swagelok 3 mm Blind plug with red cap installed on device connectors)



FlavourSpec® Torx Tool Kit

- Torx Screwdriver 8 mm (1 piece)
- Torx Screwdriver 10 mm (1 piece)

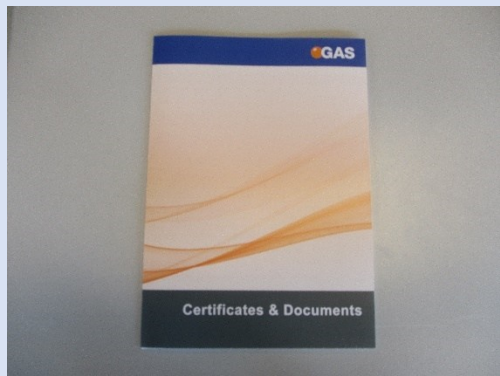

Document Map with Documents and Device User Manuals (1 piece)



USB-Stick Box with Software und Documents (1 piece)



Custom Ketones Standard (1 piece)

Autosampler PAL3 Series II Scope of Supply



Autosampler Power Supply with cable
(1 piece)



Terminal with Connection Cable (1 piece)



Agitator Connection Cable (1 piece)



PAL3 Torx Tool Kit

- Torx Screwdriver 8 mm (1 piece)
- Torx Screwdriver 10 mm (1 piece)
- Torx Screwdriver 20 mm (1 piece)
- Torx Screwdriver 25 mm (1 piece)

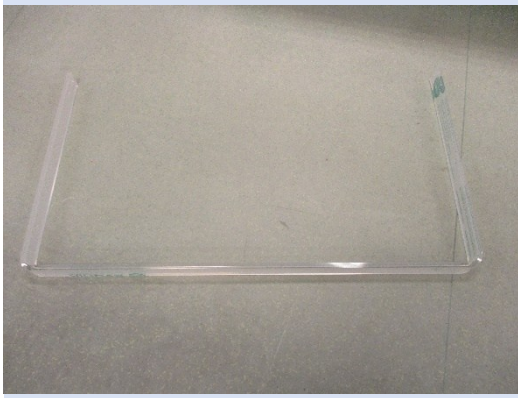

Safety Guard including screws (1 piece)



Syringe Kit (2 pieces)

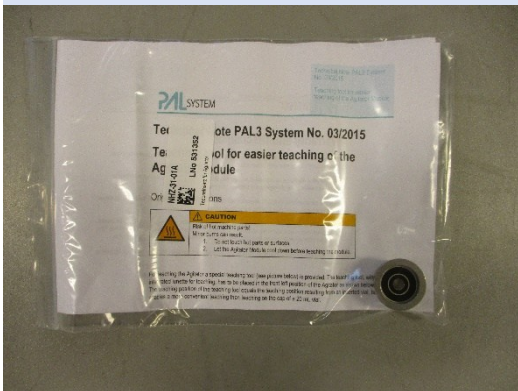

PAL3 Teaching Tool



Starter Kit

- 100 x 20 mL Headspace Vials
- 100 magnetic caps
- 3 Septa for Injector

FlavourSpec®25– User Manual

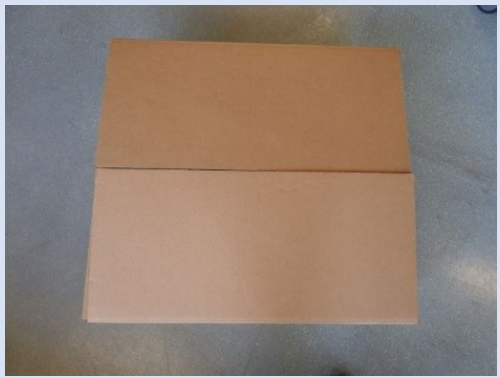

Transport box (1 piece)

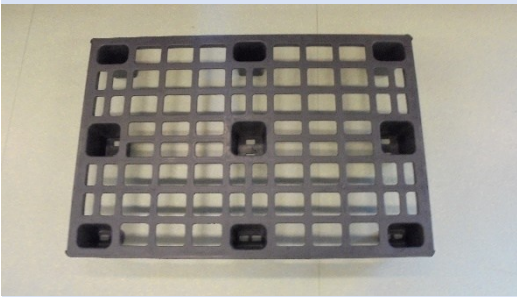

FlavourSpec® Transport palett (120 x 80 cm)

Optional Scope of Supply (only available if ordered)



Nitrogen Generator with accessories (example picture)
(optional)



Laptop Computer (different designs) including software for control and evaluation
(optional)

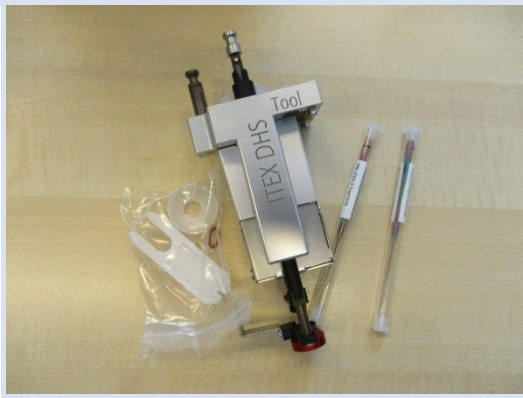

PAL ITEX-Kit



Crimper for 20 mL Headspace Vials

1.5 Liability and Guarantee

This user manual describes the safe and proper handling of the device.

All data and reference within this manual are compiled under the valid regulations, the state-of-the-art as well as G.A.S. experiences of several years.

This user manual must be stored together with and close to the device at any time and accessible to all persons, who operate or handle the device at any time.

This user manual must be read carefully before starting to work with the device. G.A.S. does not assume any liability for damage and disturbances, resulting from disregard of the instructions contained in this user manual. All claims of any kind related to damage from a not intended use of the device will be rejected.

G.A.S. reserves the right to realize technical changes of the product due to improvements without explicitly mentioning them.

1.6 Copyright

The manual is confidential. It is beyond doubt exclusively made and also meant for the personnel directly dealing with the equipment. All data, texts, designs, pictures and other representations within this manual are protected in the sense of the copyright law and are subject to further commercial patent rights. Each abusive is punishable by law.

Passing it on to third persons as well as duplications in any kind and form - also in part - as well as the use and/or report of contents are not permitted without written agreement of the manufacturer. Offences lead to payment of damages. We reserve ourselves all rights of the practice of commercial patent rights.

1.7 Return and Disposal

For an adequate disposal, the device or/and its equipment must be returned to the G.A.S. or to a third party authorized by the G.A.S.! For questions please contact G.A.S.

1.8 Software Updates

If there are any software updates customers will be contacted by G.A.S. Gesellschaft für analytische Sensorsysteme mbH as soon as the updates are available. The updates are free of charge within the first 12 months after delivery. Users will be provided with information about the changes and instructions for executing the updates.

1.9 Customer Service

For questions concerning G.A.S. products a customer service is available:

G.A.S. Gesellschaft für analytische Sensorsysteme mbH
Otto-Hahn-Straße 15
44227 Dortmund
Germany
Phone: +49 (0) 231 / 97 42 - 65 50
Fax: +49 (0) 231 / 97 42 - 65 55
support@gas-dortmund.de

The telephone hotline is available from monday to friday from 9:00 to 16:00 hours. In urgent cases or if you use fax or email please provide a telephone number for callbacks.

2 Safety

2.1 Intended Use Only



WARNING!

Usage other than described in this manual may damage the device and/or harm persons involved.

Do not use the device for other purposes. Damages due to misuse are not covered by the guarantee. Such damage claims will be rejected.

The device and its equipment are not certified for the employment in areas with explosive gas air mixtures.

All claims or requirements of any kind against the manufacturer and/or its authorized persons that arise due to damages from a not intended use of the device will be rejected. All damages that arise from a not intended use are of the operator's responsibility.

The intended use of the equipment and its correct handling according are described in the operating instructions of this manual. Other parts than the parts belonging to the scope of supply, may only be used after G.A.S. approval.

2.2 Responsibility of Operator

The device may only be operated in a perfect technical condition. Before putting the device into operation the condition of the device and its equipment must be checked. The information and instructions provided in this manual have to be followed at any time.

Besides the instructions provided in this manual the local rules for the prevention of accidents, general safety regulations - valid for the area of application of the device - as well as the valid environmental-protection regulations must be considered and respected.

The responsible technicians and operators have to make sure a failure-free use of the device. Responsibilities among the involved persons regarding installation, operation, maintenance and cleaning must be made clear.

2.3 Requirements of Personnel

Only authorized and trained technical personnel may work with the instruments. The operator must have received an instruction over existing and all possible dangers

FlavourSpec®25– User Manual

and should be regularly instructed in safety procedures and environmental protection and that the personnel is fully aware of the complete operating instructions and particularly the safety notes. Personnel that might be under the influence of drugs or alcohol are to be kept off the device at any time.

Technical personnel in this context are defined as skilled employees who are knowledgeable due to their educational background. In case the foreseen personnel do not have the necessary qualifications to operate the instrument, it must be trained. Further to that non-authorized personnel should not operate the device.

The competencies for the work on and with the device must be specified and kept undoubtedly at any time so that with respect to security issues no unclear situation might come up.

Any changes of the equipment, which impair security of the personnel, must immediately be reported to the operator and every person dealing with it.

2.4 Dangers

The device and its equipment is subject to an endangerment analysis. The construction and execution of the device corresponds to the today's state-of-the-art. The device is reliable in service when operated according to its intended use.



INFORMATION!

If the housing of the device is damaged, the device must not be used anymore and must be returned to the G.A.S. by using the original transportation case.



DANGER

The FlavourSpec® device contains a radioactive radiation Tritium source which in all EURATOM countries is below the exemption limit of 1 GBq for tritium acc. to Table B (column 2) of Article 26, of the Directive 2013/59 EURATOM of December 5th, 2013.

However, do not open the device! Do not try to recover malfunctions of the device! Malfunction recovery, repairs and any maintenance work may only be performed by G.A.S. or by qualified personnel authorized by G.A.S.



DANGER

The FlavourSpec® and its equipment is not certified for the employment in areas with explosive gas air mixtures (Zone 0).



DANGER

Exercise great care in handling current-carrying parts like the power supply cord. Do not get directly in touch with current-carrying parts. Do not open the housing. Do not use damaged parts.



DANGER

When Nitrogen is used as drift gas and helium as carrier gas, ignition of a helium plasma may occur due to the high voltage present in conjunction with a radiation source. This can damage the IMS.



DANGER

This symbol marks paragraphs, which describe situations in which surface parts of the device can heat up to a point where touching it or bringing objects close to it may be hazardous.

3 Transport, Packing and Storage

3.1 Inspection after Transport

Check the supply immediately after delivery concerning its completeness and/or transport damages. If you detect externally visible transport damage, do not receive the supply, or only under reservation. State the extent of the damage on the provided delivery note and/or the transportation documents of the feeder. Generate a complaint. Lodge a complaint of covered defect immediately after recognizing, as claims due to transport damages can only be made valid within the complaint periods (usually 7 days).

3.2 Packing

If no return agreement regarding the packing was agreed upon dispose the packaging material always in an environmentally friendly way and according to valid local regulations. If additional information is required please ask a recycling company.



INFORMATION!

It is recommended to **keep the transport box** for a safe return transport.

3.3 Storage and Transport

Store the device only under the following conditions:

- **When not in use store the equipment in the supplied casing**
- **Prevent unauthorized access**
- **Do not store outside**
- **Protect the equipment from moisture and dust**
- **Put protective caps on all gas sockets**
- **Avoid mechanical vibrations**
- **Do not expose the equipment to aggressive substances**
- **Protect the equipment from direct sun light**

- **Storage temperature: 5 to 40°C**
- **Relative Air Humidity: 0- 90% RH, prevent condensing**
- **Position of the instrument: Horizontal**

The device should only be transported packed in the transport box provided. In this way, transport damage can be avoided. The above-mentioned values are considered for an instrument transported in its original new packing.



WARNING!

Protective caps should be put on gas sockets in case the device is stored or transported.

4 Cleaning and Maintenance

Natural aging and the wear of certain components of the equipment require a regular cleaning and maintenance.

4.1 Cleaning

Clean the device only with a dry or slightly damp cloth.



WARNING!

Do not use cleaning agents that contain solvents, acids or bases.

4.2 Maintenance



INFORMATION!

Maintenance of the device should only be carried out at G.A.S. or through specially trained and by G.A.S. authorized personnel.

The recommended **maintenance interval is 24 months**.

5 Introduction

5.1 Working principle of IMS technology

Ion Mobility Spectrometry (IMS) is an analytical technology to separately detect gaseous compounds in a mixture of analytes. The separation is based on the specific drift times, that ionized compounds need to pass a fixed distance (drift tube) in a defined electric field.

$$\text{Drift velocity: } v_d = KE$$

$$\text{Mobility: } K = \frac{L^2}{t_D U}$$

$$K = \frac{3}{16} \sqrt{\frac{2\pi}{\mu kT}} \frac{Q}{n\sigma}$$

Q	<i>ion charge</i>
n	<i>drift gas number density</i>
μ	<i>reduced mass of the ion and the drift gas molecules</i>
k	<i>Boltzmann constant</i>
T	<i>drift gas temperatures</i>
σ	<i>ion's collision cross section with the drift gas</i>

Figure 1: Ion Mobility Spectrometer - Basic Relations

Compared to other techniques e.g. TOF-MS, ions travel at atmospheric pressure versus a flow of inert drift gas. The drift time of each substance is determined by its ion mass and geometric structure, as slowing collisions with the drift gas molecules are more frequent for sterically demanding structures. Therefore, IMS can even differentiate isomeric molecules. For detection, the resulting ion current is measured by an electrometer as a function of time.

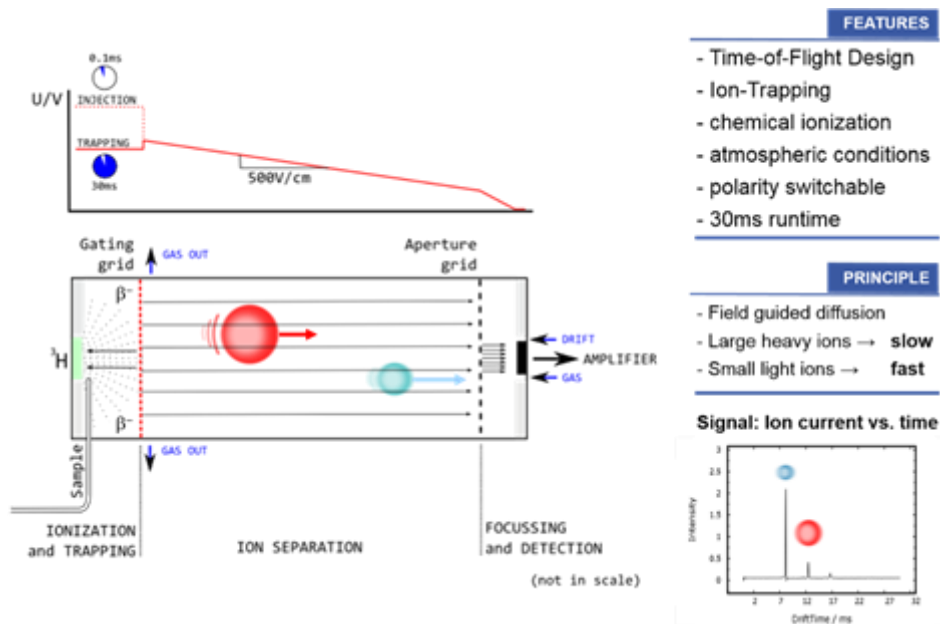

Figure 2: Ion Mobility Spectrometer -Working Principle

Atmospheric Ionization of molecules can be obtained by several techniques. G.A.S. uses photoionization with a 10.6eV UV-lamp or soft chemical-ionization initiated by a low-radiation tritium (H3) source (below exemption limits of EURATOM). While the first directly produces positive ions, the latter generates *reactant ions* with the gas atmosphere by a cascade of reactions following the collision of a fast electron emitted from the β -radiator H3. The so-called Reaction Ion Peak (RIP) representing the total of all ions available is formed as a first step. In nitrogen and air, resp., the *reactant ions* can be described as $H^+(H_2O)_n$ and $O_2^-(H_2O)_n$. Chemical ionization of analytes by *reactant ions* then result in the formation of specific analyte ions, when the affinity of the analyte towards the reactant ion is higher in case compared to water (using the positive ionization mode). The proton affinity of water is 691kJ/mol, so all molecules with a higher proton affinity will be ionized by a proton transfer, which is typically given for all heteroatom-organic compounds. The ionization takes place at ambient pressure, so that the analyte concentration is not diluted as compared to other analytical methods where a vacuum must be applied. Therefore, IMS is extremely sensitive. The detection limits typically are in the low ppb-range for *volatile organic compounds (VOC)*.

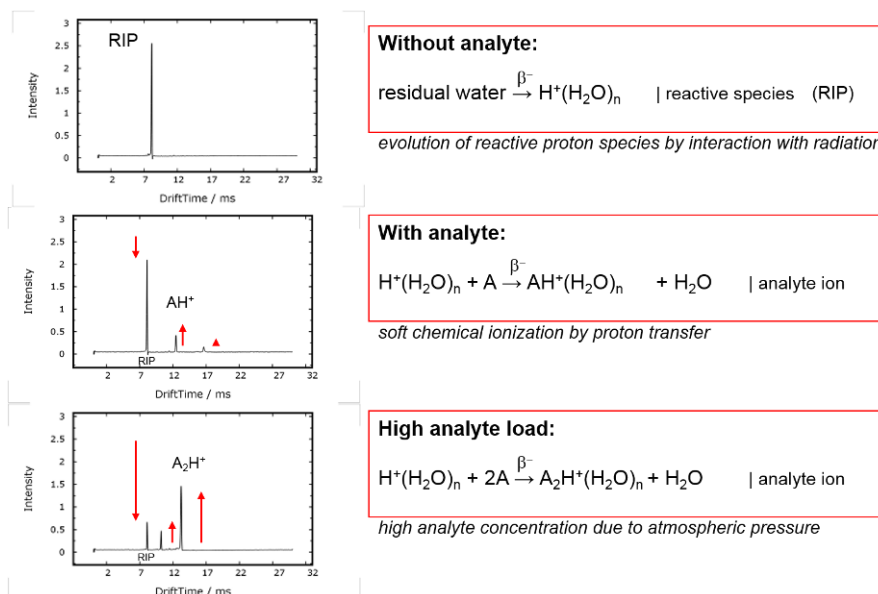

Figure 3: IMS Predominant Ionization (positive polarization)

The above figure exemplarily shows typical IMS spectra without analyte and with analyte. The RIP is formed as a sharp signal proving the cleanliness of the system and at a specific position that is used as internal standard. The spectrum containing analytes shows a decreased RIP, while new (analyte) peaks are correspondingly formed. The drift time is specific to each ion, therefore analyte identification is possible. The peak height and area correlate with the analyte concentration, so that a quantification is also possible.

Proton Affinities	Aromatic Amines	930.0 KJ/mol	Pyridine
	Amines	899.0 KJ/mol	Methyl Amine
	Phosphorous Compounds	890.6 KJ/mol	Trimethylphosphate
	Sulfoxides	884.4 KJ/mol	Dimethyl Sulfoxide
		853.6 KJ/mol	Ammonia
	Ketones	832.7 KJ/mol	2-Pentanone
	Esters	821.6 KJ/mol	Methyl Acetate
	Alkenes	805.2 KJ/mol	1-Hexene
	Alcohols	789.2 KJ/mol	Butanol
	Aromatics	750.4 KJ/mol	Benzene
		691.0 KJ/mol	Water
	Alkanes	543.5 KJ/mol	Methane

Source: Gary Eiceman & Zeev Karpas, *Ion Mobility Spectrometry*, CRC Press, 2005, ISBN 0-8493-2247-2

Proton affinities of various VOCs can be found at the NIST chemistry webbook
<http://webbook.nist.gov/chemistry/>

Figure 4: Proton Affinities of VOC's

Complex analyte mixtures, like e.g. food flavours, often demand a second and independent separation step to separately analyse the multiplicity of compounds at low concentrations. Therefore G.A.S. -according to application- equips its IMS systems with gas chromatographic (GC) columns. The volatile compounds of samples under testing are pre-separated in time by a GC column. The discrete compounds are consecutively fed into the IMS ionization chamber, so that analyte and/or ion interactions are avoided.

Furthermore, a competition of analytes on the reactant ions is excluded, enhancing the sensitivity of the system for individual compounds.

The GC-IMS setup enables a twofold separation of analyte mixtures and the detection by the IMS electrometer. Since the IMS measurements are extremely fast (30ms / spectrum) a continuous and high-resolution recording of analyte signals is provided.

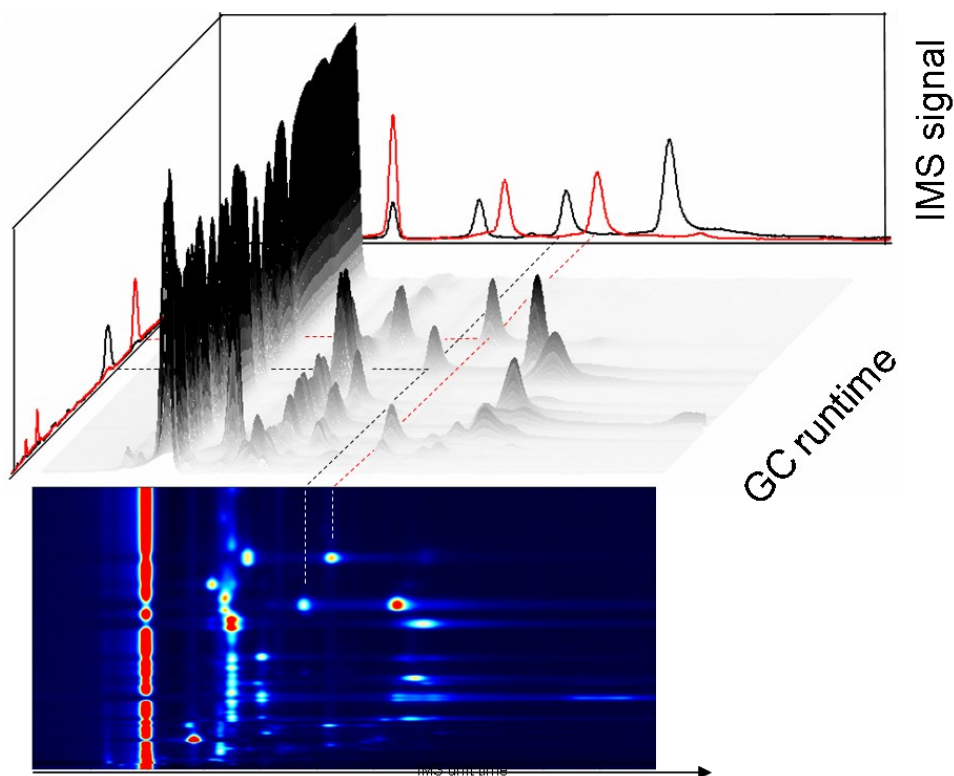

Figure 5: GC-IMS measurement 3D

The above figure sketches the GC-IMS measurement's 3D-dataset and the corresponding heatmap visualization.

FOCUS-IMS®

The FOCUS-IMS is designed to optimize detection and mapping of fast temporal changes in sample feed. This is especially important for systems where IMS is coupled to temporal pre-separation techniques, like gas chromatography.

FOCUS-IMS's sample feed is guided straight onto the ionization source, which is mounted self-supporting perpendicularly to IMS drift tube. This ensures immediate ionization and detection of analyte molecules. Subsequent sample wash-out is ensured by wide exhaust pathways in-line to the drift gas flow and is driven by both consecutive carrier gas- and the drift gas flow.

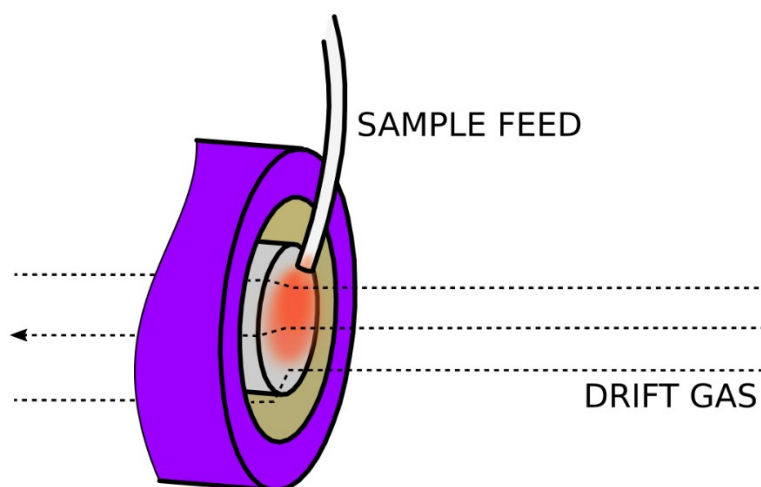

Figure 6: Schematic of the sample- and drift gas flow paths

The inherent detector's void volume is built by a 'bubble' of sample feed (carrier gas flow) in interplay with the drift gas flow. This 'virtual' void volume is smaller than the geometrical volume and is characterized by a decreased sample dwell time and subsequent to better detector signal mapping of changes in the sample feed. When coupled to gas chromatography a signal peak tailing due to residual sample is decreased.

Drift gas flows become a relevant parameter for the FOCUS-IMS. High drift gas flows reduce sample dwell time and hence reduce the respective detector sensitivity. This can be utilized to tune the IMS response dynamically. The following image plots the chromatogram of the subsequent measurements of a homologous series of linear 2-ketones (#C 4-9). Drift gas flows are 50 - and 150 ml/min (left- and right-hand chromatogram). The chromatogram plotted in centre runs a drift gas flow of 150 ml/min and switches to 50 ml/min in a distinct run time (here: 2-heptanone).

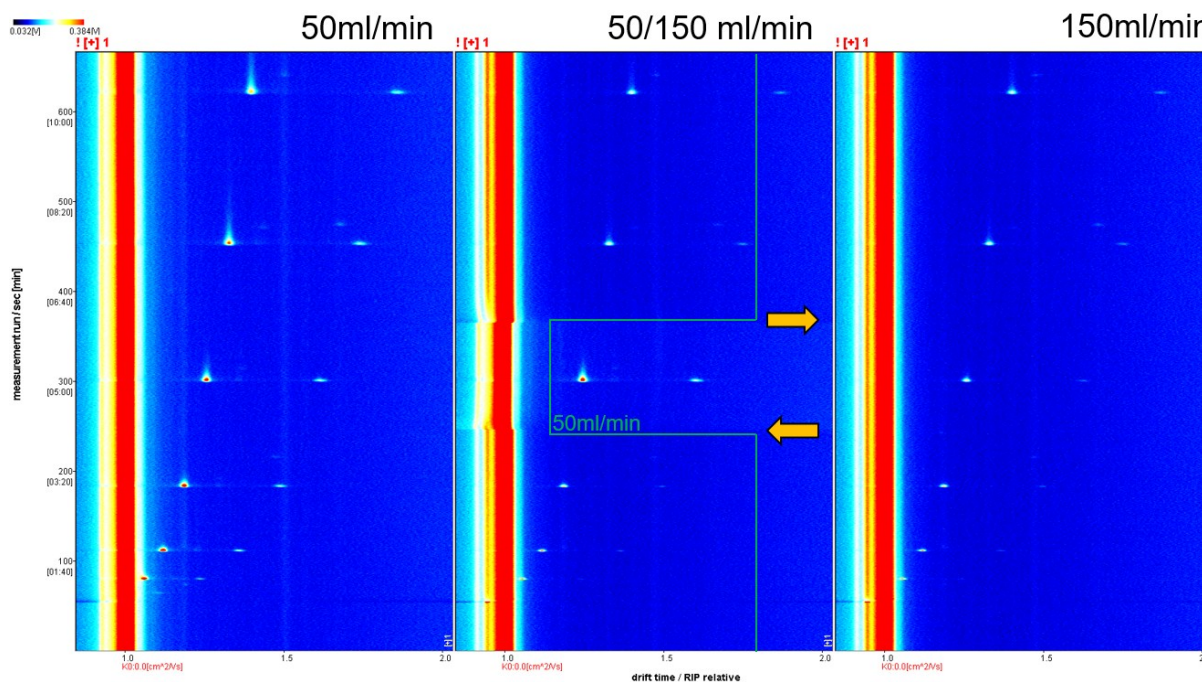

Figure 7: Chromatograms of 2-ketones (C 4-9) for varying drift gas flows

Reduced drift gas flows increase the signal peak heights. Dynamic change of flows within a GC run is possible to selectively tune sensitivity.



INFORMATION!

The drift gas flow is a relevant parameter for FOCUS-IMS® systems: **Elevated drift gas flows** will enhance temporal signal peak mapping and will reduce peak tailing.

Lowered drift gas flows will increase detector response and sensitivity.

Reasonable starting value for drift gas flows in method development is 75 ml/min.

5.2 Purpose of the device

The FlavourSpec® represents the synergies of a fast gas chromatograph and the outstanding sensitivity of an IMS. Thus traces of Volatile Organic Compounds (VOCs) become detectable without any special sample preparation.

The purpose of the FlavourSpec® is the headspace-measurement of traces of volatile organic compounds (VOCs) of solid or liquid samples.

Results are available within a few minutes and compounds are typically detectable even at ppbv-/pptv-levels. The technical configuration, its menu as well as its extremely easy. The headspace samples are introduced into the FlavourSpec® system by injecting them with a gastight syringe into the sample injection port at the top of the housing.



WARNING!

The FlavourSpec® device must not be operated by introducing aggressive gases or any kind of liquids or solids. The operational reliability is only ensured when the equipment is applied for this intended purpose.



INFORMATION!

Any use of the device, that differs from the intended purpose will be regarded as “out of purpose”. Any claims of any kind against G.A.S. or her associates that are related to damages from an use not covered by the aforesaid will be rejected.

The FlavourSpec® contains several parameterized components that can be modified for optimizing measurement data in terms of separability of substances and clarity of resulting peaks.

The FlavourSpec® can be operated in negative or positive drift voltage mode. The reactant ion peaks (RIPs) and analyte ion peaks (AIPs) in the positive drift voltage mode will be displayed as maxima in the spectra. In the negative drift voltage mode both will be shown as minima. One of these modes may be more suitable for specific substances.

The FlavourSpec® can be operated together with an automatic sampling system (auto-sampler) for batch processing. Measurements can be initiated by the connected auto-sampler as the auto-sampler and instrument have a master/slave configuration. To do so the instrument has to be in the trigger mode. The syringe of the auto-sampler will transport the headspace sample from the vial to the injector port where it injects a defined volume.

When no auto-sampler device is connected, the injection of headspace gas can be done manually using a gas-tight headspace syringe.

Measurement data can be acquired by employing user-defined measurement programs. In these programs the operational parameters of various components of the FlavourSpec® can be modified at defined sequences of the measurement run.

Alternatively measurement data can be acquired in a manual way using the “Monitoring” mode.

Acquired measurement data are stored in measurement files either on the internal storage volume of the FlavourSpec® or – when activated – in a shared network folder. Stored measurement files can further be copied to a connected USB volume.

For using a shared network folder the FlavourSpec® can be integrated into a local area network (LAN) by using the Ethernet socket at the rear side of the device.

5.3 Principle setup and internal gasflow

The schematic drawing shows the principle structure of the FlavourSpec® gas flow system. The system consists of the IMS, which is coupled with a gas chromatographic column.

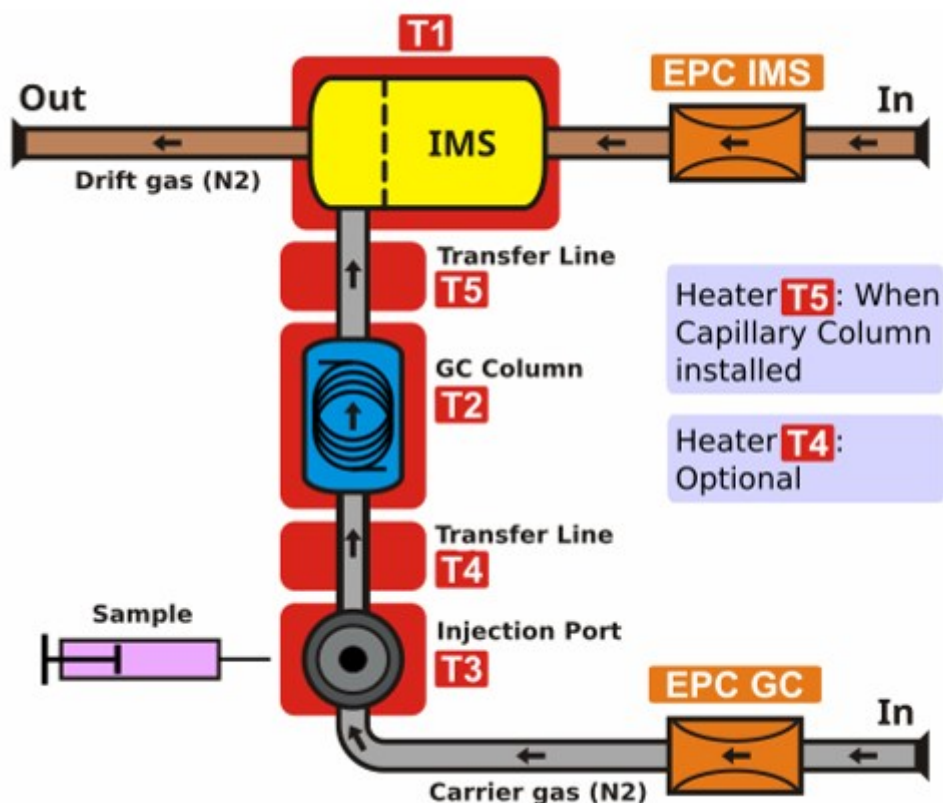

Figure 8: GC-IMS device plan (exemplary)

The drift gas for the IMS is supplied via an electronic pressure control unit (EPC IMS). The carrier gas for the column is supplied via a second electronic pressure

FlavourSpec®25– User Manual

control unit (EPC GC). Both gases (carrier and drift gas) leave the device at the gas outlet, which should be connected to an exhaust system.



INFORMATION!

To ensure correct measurements it is absolutely necessary to **connect the supplied exhaust tubes** (Gas Out and Sample Out).

The exhaust tubes (Gas Out and Sample Out) **must be led separately into the exhaust system and must not be connected.**

The exhaust system must **not generate any negative pressure.**

IMS (T1), GC-Column (T2), Injection Port (T3) and Transferline (T4 and T5) are heated.

The headspace sample is introduced into the FlavourSpec® system by injecting with a gastight syringe into the sample injection port at the top of the housing.

The carrier gas stream now transports the sample gas to the GC-column, where the substances in the sample gas are separated by time. The eluting substances are introduced into the ionization region of the IMS and leave the system via the Gas Out socket.

5.4 Housing Device Versions

5.4.1 FlavourSpec®

5.4.1.1 Front

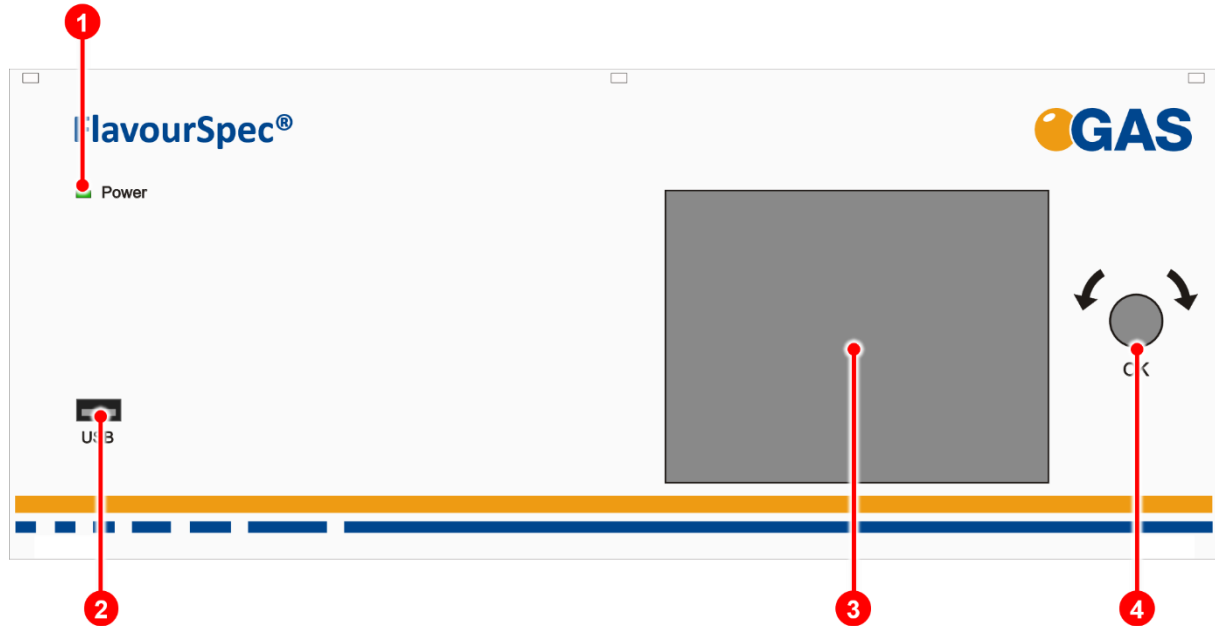

Figure 9: FlavourSpec® - Housing of device - Front

<p>1</p>	<p>Power LED</p>	<ul style="list-style-type: none"> ■ Indicates whether or not the device is connected to a Power Supply and is switched on ■ Indicates an internal system error.
<p>2</p>	<p>USB Socket</p>	<p>USB socket for connecting external USB storage volumes. These volumes can be used for:</p> <ul style="list-style-type: none"> exporting measurement files importing sample name lists importing programs updating the firmware of the device saving/loading system settings
<p>3</p>	<p>Touch screen Display</p>	<p>Displays the graphical user interface and allows the control of the device by touch screen.</p>

4	Pushable Rotary Knob	Input control for cycling through and activating the control elements of the graphical user interface.
----------	-----------------------------	--

5.4.1.2 Rear

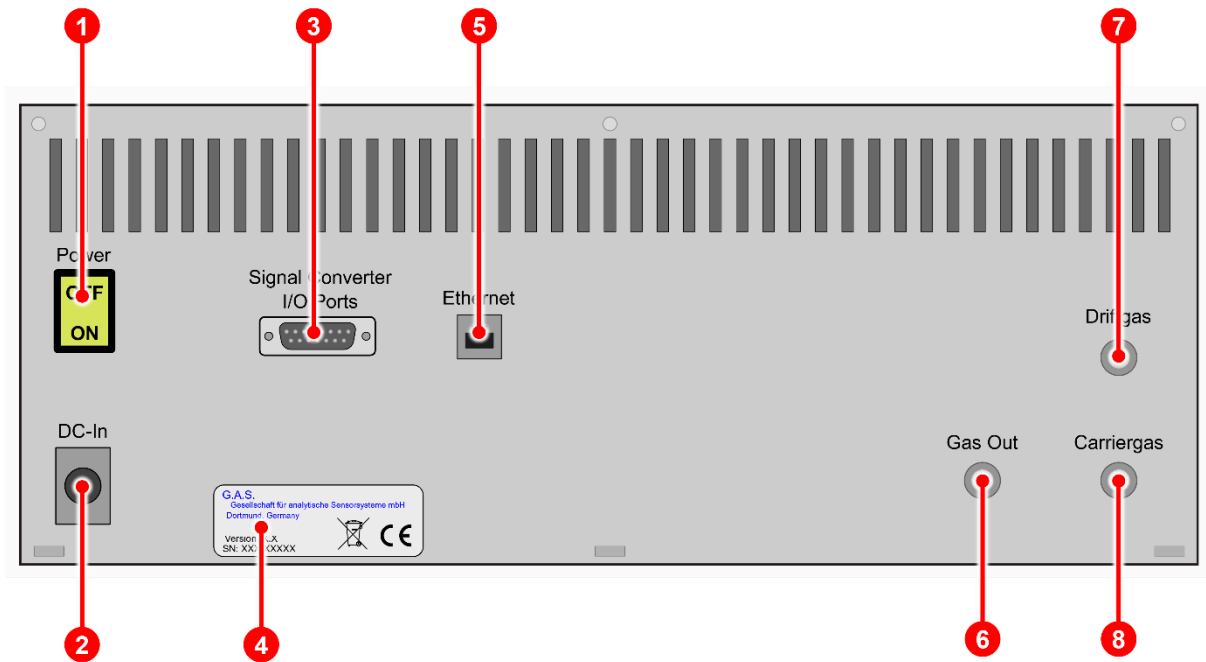

Figure 10: FlavourSpec® - Housing of device - Rear

1	Power Switch	Switches the device on or off.
2	DC-In Socket	24 V XLR-Connector for connecting the Power Supply.
3	Signal Converter –I/O Socket	Socket for connecting a PLC (Programmable Logic Controller) or other devices.
4	Device Type/Serial Number Plate	Displays manufacturer identification, device type, serial number.

5	Ethernet Socket	Socket for connecting the device to a local area network (LAN) or directly to a computer.
6	Gas Out Socket	3 mm Swagelok plug for connecting the device to an adequate laboratory waste gas ventilation system/fume hood.
7	Drift Gas In Socket	3 mm Swagelok inlet plug for connecting the device to a drift gas source.
8	Carrier Gas In Socket	3 mm Swagelok inlet plug for connecting the device to a drift gas source.

5.5 Device Type / Serial Number Plate

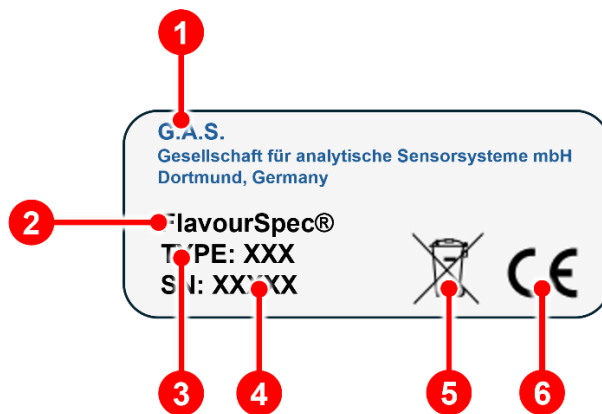

Figure 11: Device Type / Serial Number Plate

1	Manufacturer
2	Type Name
3	Version Number
4	Serial Number

5

Disposal Instructions

This marking on the instrument indicates that they must not be disposed of in domestic waste. The disposal is carried out by return to the manufacturer or by the corresponding municipal authorities (see EU directive 2012/19/EU)

6

CE Marking

CE, Communauté Européenne

Instruments bearing this mark comply with the relevant European directives

6 Operating Interface

The graphical user interface of the device can be controlled by using the touchscreen in combination with the pushable Rotary Knob at the front of the device.

The selected control (button, input field etc.) element is marked blue. To activate it the knob can be pressed.

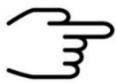

INFORMATION!

As the product is under continuously development, the screen shots in this user manual may differ from the actual conditions.

All possible functionalities of the firmware are described.

Depending on the hardware some functionalities are not available.

6.1 Overview

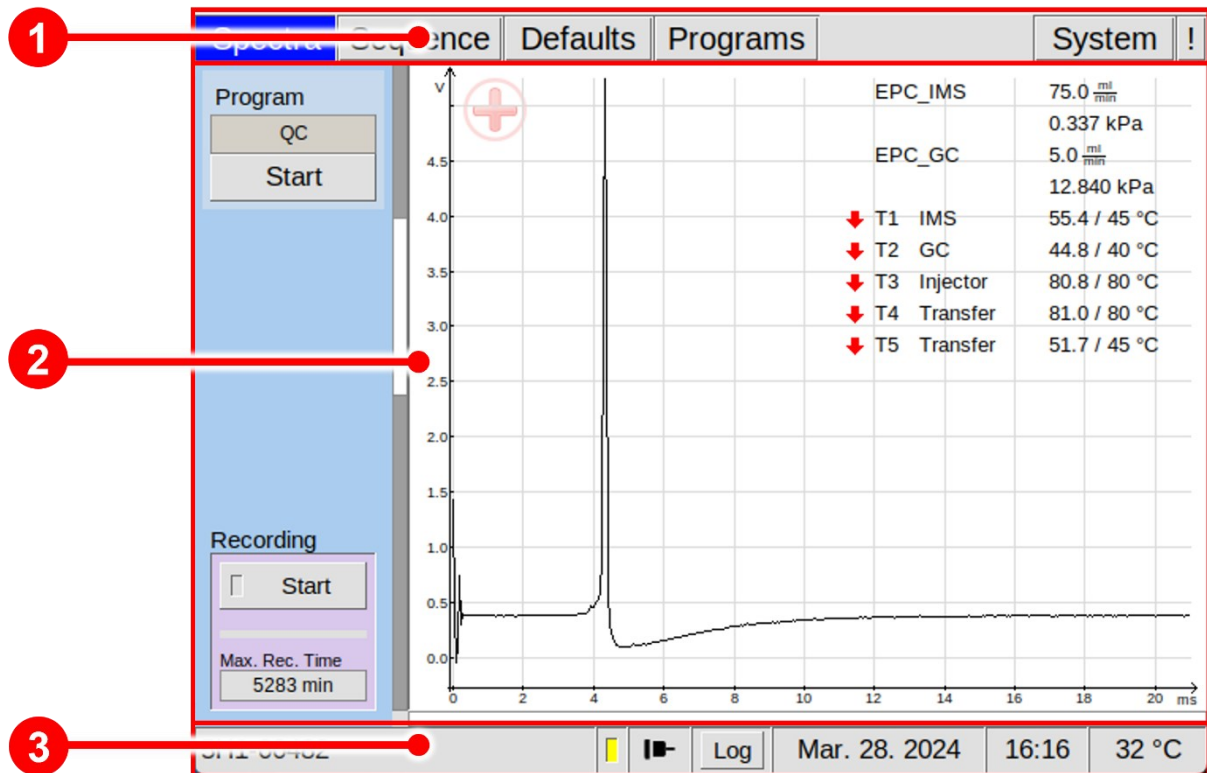

Figure 12: Operating Interface - Overview

1	Window Selection Bar	The main windows can be selected.
2	Window Display Area	The content of the selected main window will be displayed.
3	Status Bar	Status messages and system information are displayed.

6.1.1 Windows Selection Bar

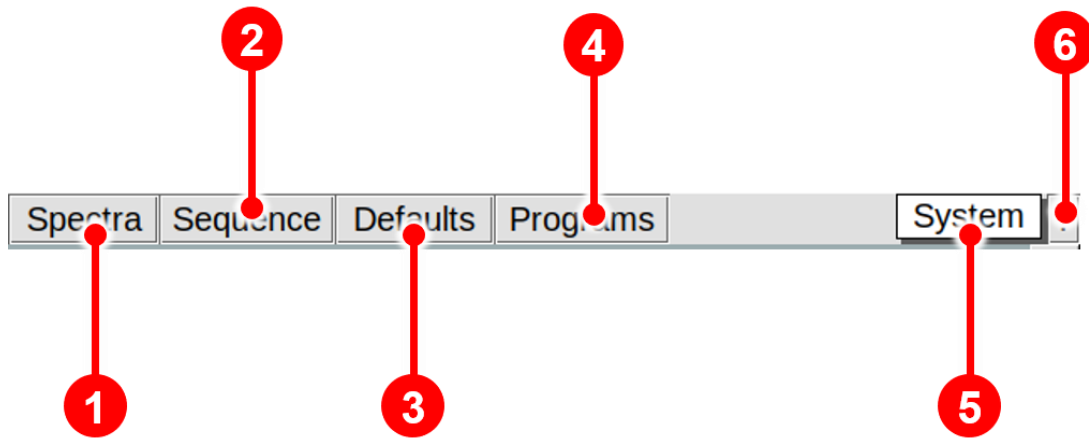

Figure 13: Operating Interface - Windows Selection Bar

1	Spectra Window Tab	In Spectra Window the data acquisition process is controlled.
2	Sequence Window Tab	In Sequence Window user created sequence files using the Sequence Designer software can be imported.
3	Defaults Window Tab	In Defaults Window the default settings can be set.
4	Programs Window Tab	In Programs Window user-defined measurement programs can be set.
5	System Window Tab	In System Window system specific information are displayed system specific settings and can be set.
6	Errors Information Window Tab	In Error Information Window current error information are displayed.

6.1.2 Windows Display Area

In Window Display Area the content of the following main windows is displayed:

- **Spectra Window**
- **Sequence Window**
- **Defaults Window**

- Programs Window
- System Window
- Error Information Window

6.1.3 Status Bar

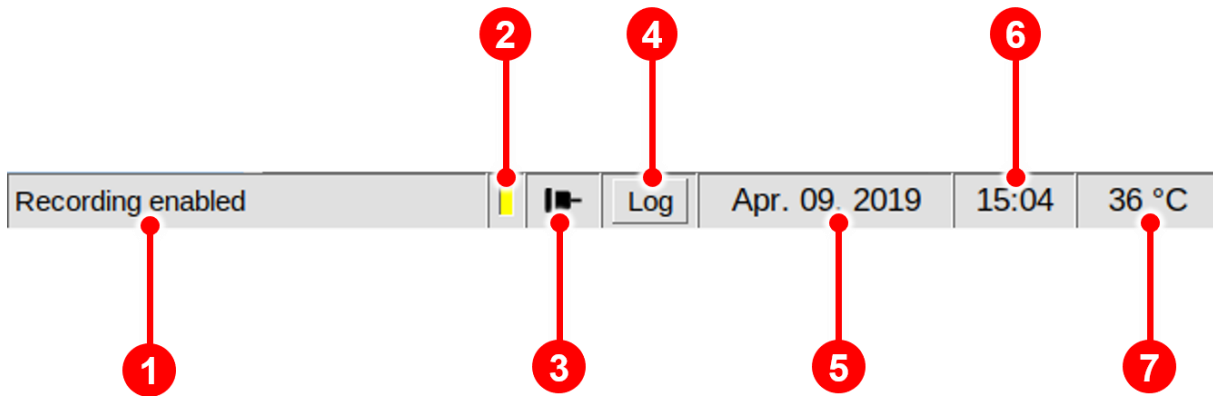

Figure 14: Operating Interface - Status Bar

1	Status Message Section	Device Serial Number and Device events information will be displayed.
2	Export Message Section	Displays the current connection status. Export on: Export of
3	LAN Connection Section	Displays the current connection status: Connected: Disconnected:
4	Log Section	Displays the current log status. New entry: No modification:
5	Date Section	Displays the current date of the device clock. It can be set in System Window.
6	Time Section	Displays the current time of the device clock. It can be set in System Window.
7	Temperature Section	Displays the current inner housing temperature of the device.

6.1.4 View Control Bar

The view control bar function is available in the Spectra window and in the Defaults window. Touch the screen to display the control bar below the displayed spectra.

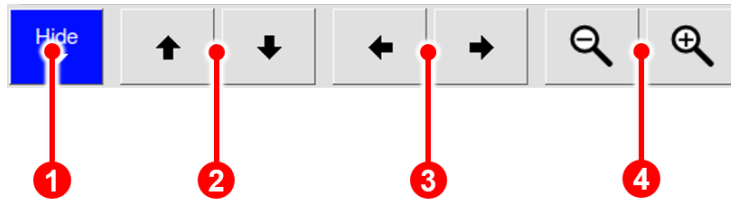

Figure 15: Operating Interface – View Control Bar

1	Hide Button	The control bar can be hidden manually. After 3 seconds of inactivity it is hidden automatically.
2	Vertical Control Buttons	Moves the vertical position of the display area on the screen up or down.
3	Horizontal Control Buttons	Moves the horizontal position of the display area on the screen left or right.
4	Zoom Control Buttons	Reduces or enlarges the view of the display area on the screen.

6.1.5 Low/High Pressure Control

The device pressure is monitored. Two types of error are defined:

6.1.5.1 Low Pressure Error

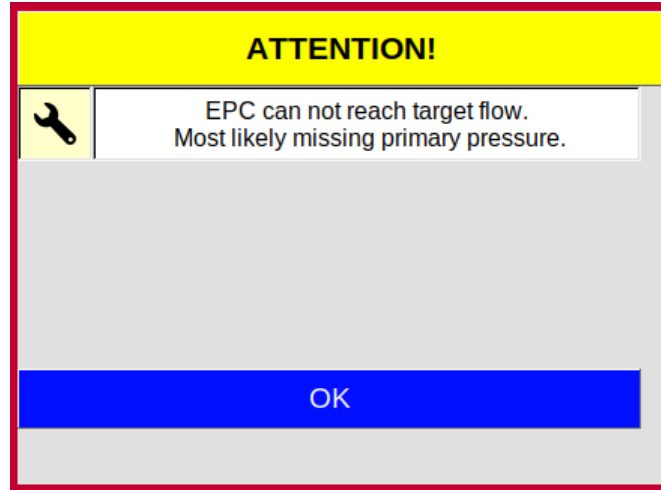

Figure 16: Operating Interface - Low Pressure Alarm Box

1. After 10 seconds a dialogue box is displayed and an acoustic alarm sounds.
2. After 5 minutes all temperature controllers are switched off.
3. When the pressure is reached again the alarm is switched off and all temperature controllers switch themselves on automatically.

6.1.5.2 High Pressure Error



WARNING!

High pressure can destroy the device.

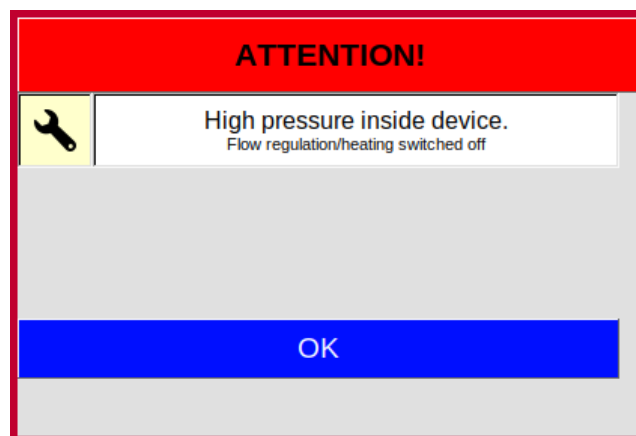

Figure 17: Operating Interface - High Pressure Alarm Box

FlavourSpec®25– User Manual

1. If overpressure is detected, a visual and audible alarm is triggered immediately. At the same time all temperature controllers and flow controllers are switched off.
2. Before continuing to operate the unit, the cause of the spotlight must be eliminated.
3. By confirming the dialogue box or restarting the system, all temperatures and flows are reset to their normal values.

6.2 Spectra Window

6.2.1 Overview

After switching on the device and the system start is completed the Spectra Window is displayed. In the Spectra Window the data acquisition can be controlled.

The current spectrum is displayed. The Recording Mode can be activated. The selected measurement program can be started.

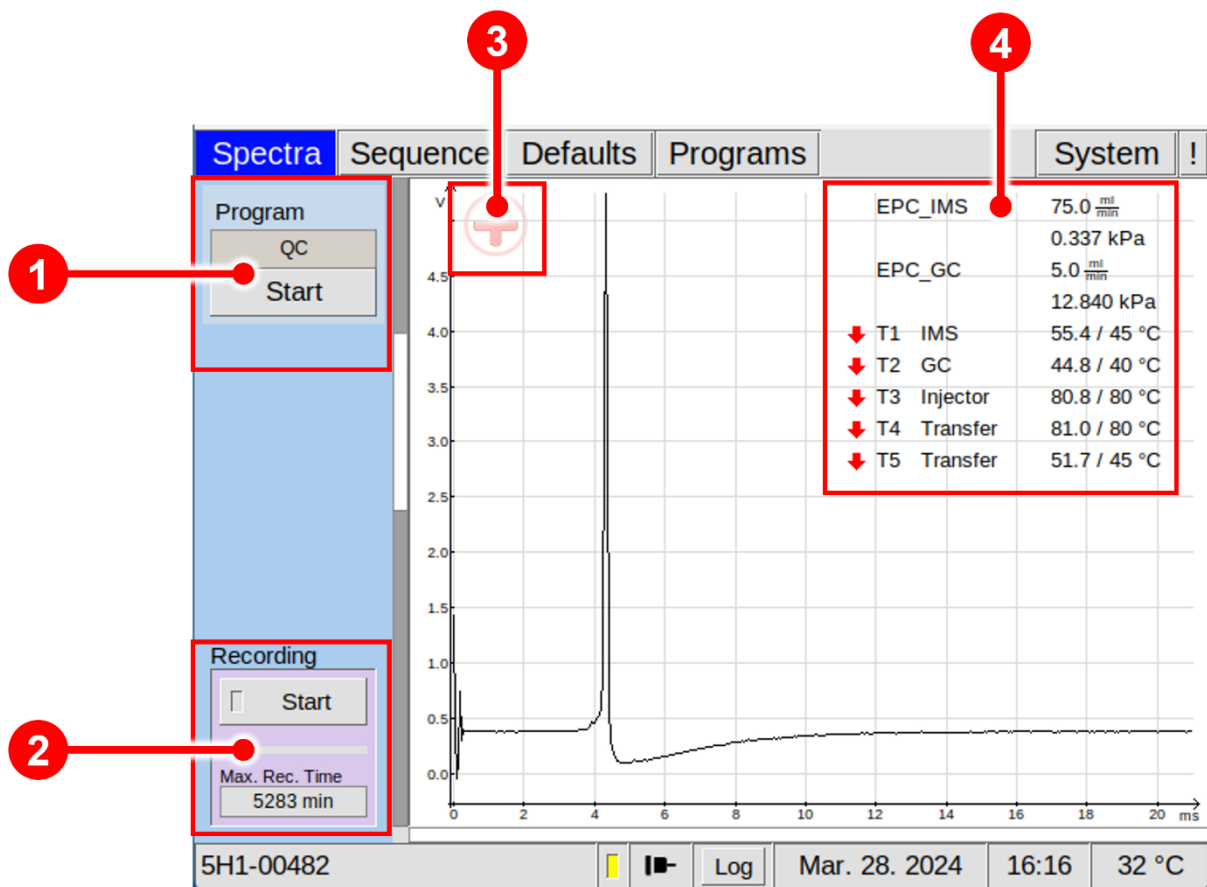

Figure 18: Operating Interface - Spectra Window

1	Program Start Button	By selecting this button the displayed program is started.
2	Recording Check Box	The live monitoring of measurements can be recorded manually. The available storage capacity in minutes is displayed.
3	Drift Voltage Mode	Displays the current selected drift voltage state (positive / negative).
4	Device Parameter	Displays the current temperature, flow and pressure values.

6.2.2 Measurement modes

Four measurement modes are available:

- Measurement with user defined programs
- Manually operated measurement (Recording)
- Automatic operated measurement with coupled Autosampler (Trigger Mode)
- Remote controlled measurement with Sequence Designer

6.2.2.1 Measurement with user defined programs

In this mode data acquisition with user-defined measurement programs can be started. The executable measurement program can be created and selected in the Programs Window. The name of the current selected program is displayed in the upper left of the Spectra Window. The selected measurement program can be started by activating the Program button in the upper left of the Spectra Window.

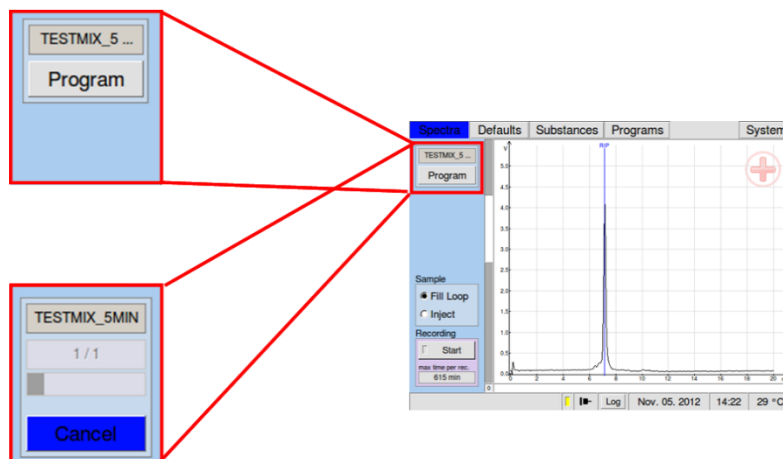

Figure 19: Start Program

6.2.2.2 Manually operated measurement (Recording)

To record a measurement manually the Recording button can be switched on. If recording is not active the button is set to **START** and the checkbox is grey. If recording is active the button is set to **STOP** and the checkbox is yellow.

In this case a measurement file is generated from the recorded data and saved to the internal flashcard. The remaining time for data storage to the internal flashcard is shown. It depends on the number of measurement data that were released for export but were not yet exported and their file size depends on the value of spectra averages that are used.

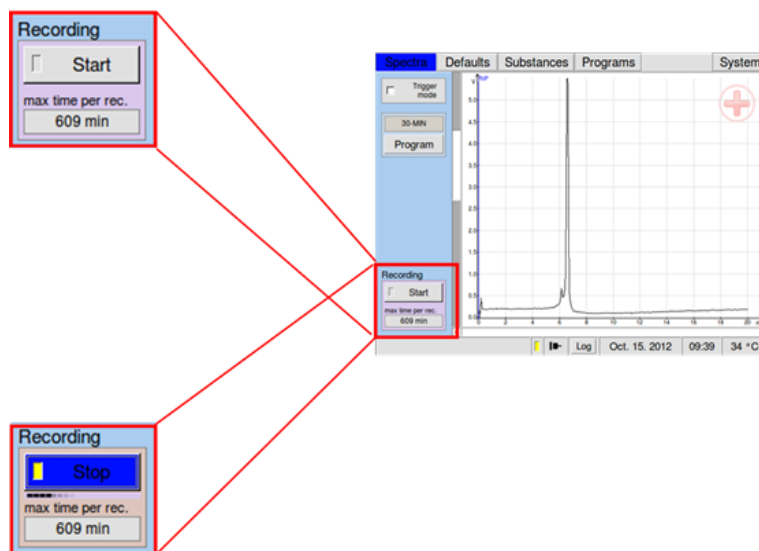

Figure 20: Recording Check Box

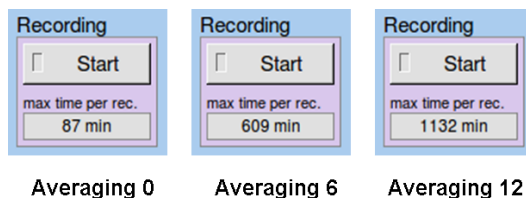

Figure 21: Recording Check Box

6.2.2.3 Automatic operated measurement with coupled Autosampler (Trigger Mode)

In the Trigger Mode the FlavourSpec® device is remotely controlled by a connected autosampler that operates as master device to it. When the Trigger Mode is active the Acquisition Control Area on the left side of the window displays a different set of controls.

Instead of the Recording Mode the Sample Names List and the Import Names button are displayed. The Program Start button is inactive because in this mode the currently selected program is started by an external trigger sent from the connected autosampler. The measurement program that will be executed can be selected in the Programs Window.

The Sample Names List displays the currently loaded ordered list of sample. The sample names are consecutively assigned to measurements triggered by the connected autosampler. The list must therefore match the order and kind of the

FlavourSpec®25– User Manual

autosampler samples batch. The Sample Names List can be imported by activating the Import samplenames button.

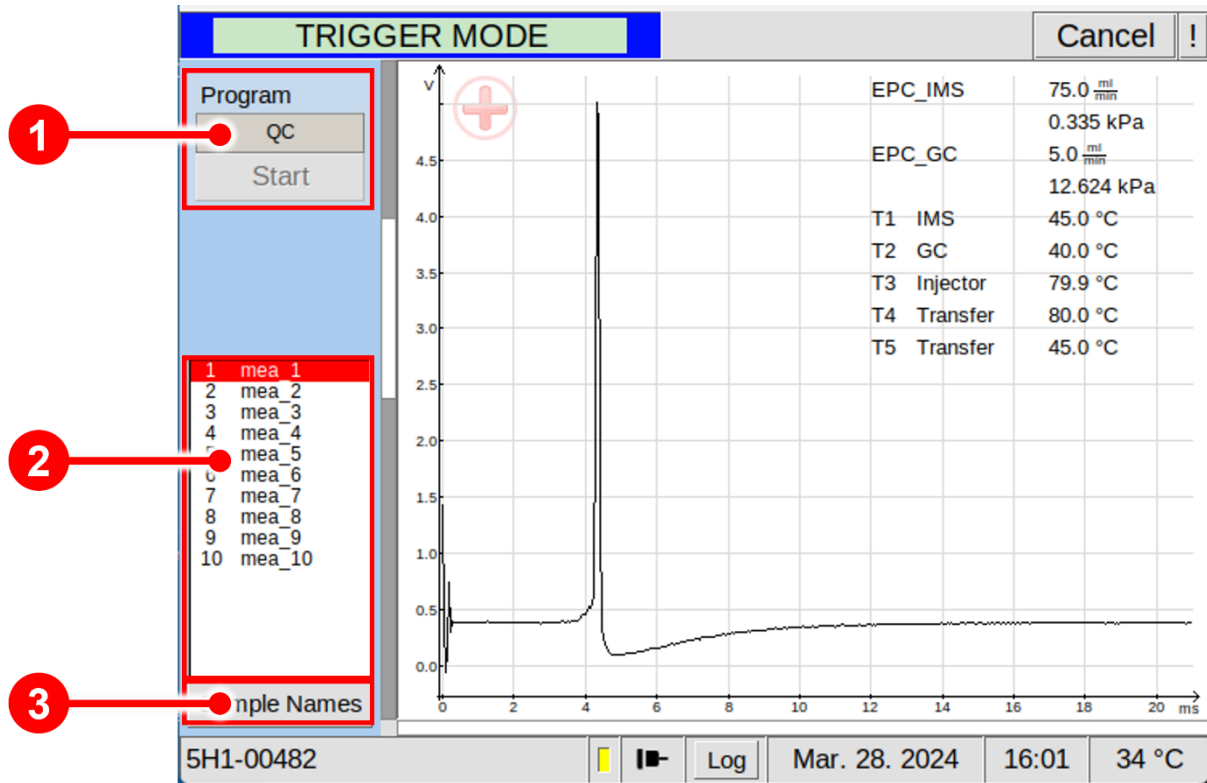

Figure 22: Trigger Mode Window

1	Trigger Mode View	Shows the activated program in the trigger mode.
2	Sample Names List	Displays the currently loaded sample names list. The current sample name is highlighted red.
3	Sample Names Button	With this button the sample names list file can be (re)loaded.

6.2.2.4 Create and Import Sample Names Lists

The FlavourSpec® can hold a list of sample names which are assigned to specific measurements during an autosampler batch measurement process. A list of sample names can be imported by the FlavourSpec®. The sample names in this list are consecutively assigned to measurement data recordings triggered by the connected autosampler device and written into the resulting measurement files. The list must

therefore match the order and kind of the autosampler samples batch. Usually these names should correspond to the content of the sample vials on the autosampler tray.

The sample name list can be generated as follows:

- Autogenerate function of the device
- Manual editing with an editor application

The sample name list can be loaded from a file located in a folder in the shared network folder of the device or on a connected USB volume.

When both a USB device and a shared folder are connected the USB device will be chosen.

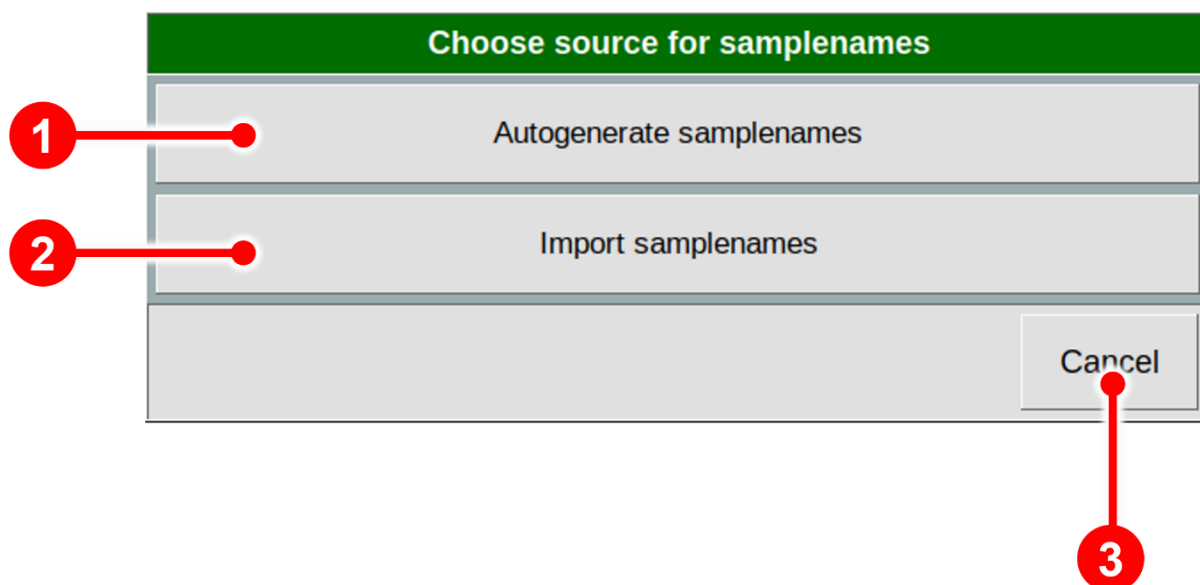

Figure 23: Choose source for samplenames 1

1	Autogenerate samplenames	Autogenerates a sample names list named mea_1 – mea_999 (max)
2	Import samplenames	Imports a sample names list file from a connected USB device or a connected shared network folder.
3	Cancel	Aborts the action

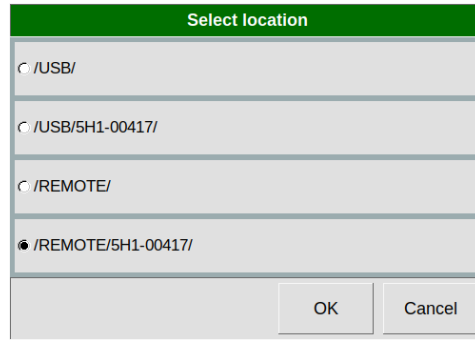

Figure 24: Choose source for samplenames 2

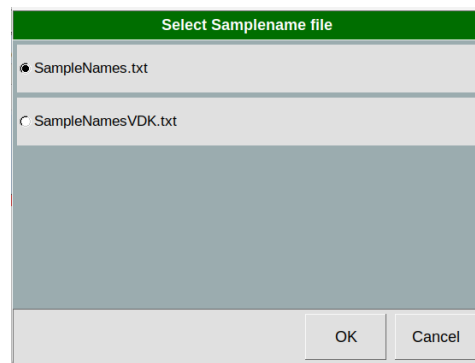

Figure 25: Choose source for samplenames 3

6.2.2.5 Creating a Sample Name file

The file must be a plain text file which can be created or edited with a simple text editor application such as the Microsoft® Windows® Notepad. The content of each text line in this file will be regarded as one sample name. The order of the sample names in the file corresponds to the order of the sample names after the import.

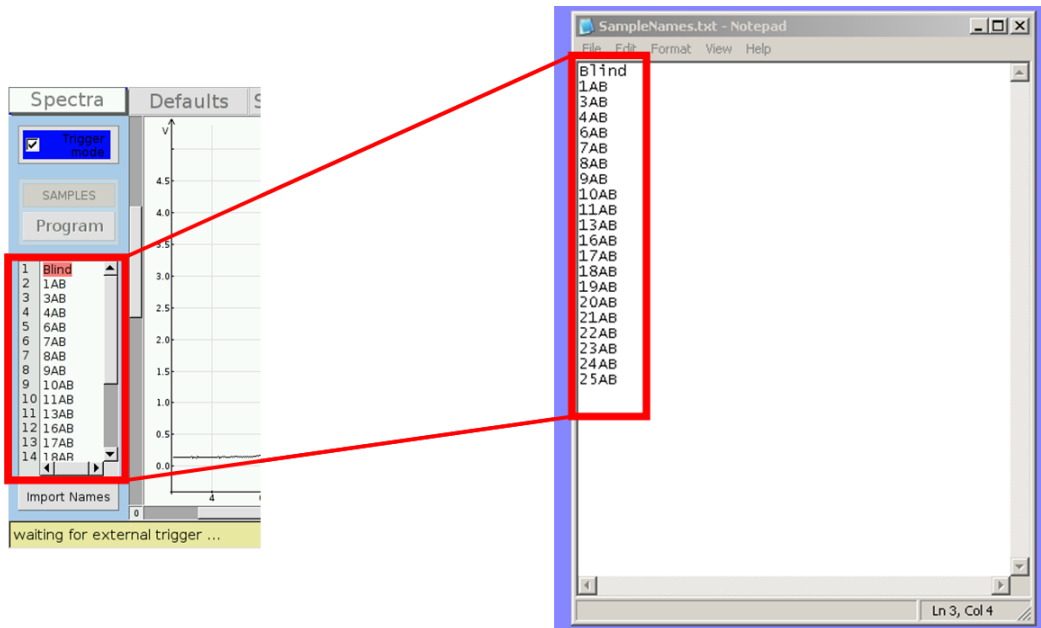

Figure 26: Sample Names List

By entering of tags (so-called XML-tags) in front and behind the samplename-string the samplename can be appended to the default filename which is created from the day and time information when the measurement is started:

The default (autogenerated) Filename format is defined as follows:

YYYYMMDD_hhmmss.meas

Use the tags in front and after the samplename string as shown below:

<FILENAME>samplename</FILENAME>

This produces the user-defined Filename as follows

YYYYMMDD_hhmmss_samplename.meas

The XML tags must be entered in all capital letters. The samplename can contain upper and lower case letters as well as numbers. Special characters are not allowed, except the underscore character. If a special characters is used it will be automatically converted to underscore.

6.3 Sequence Window

In Sequence Window Sequence files can be imported and started by clicking on the Start Button. The processing status of a user created sequence file can be monitored:

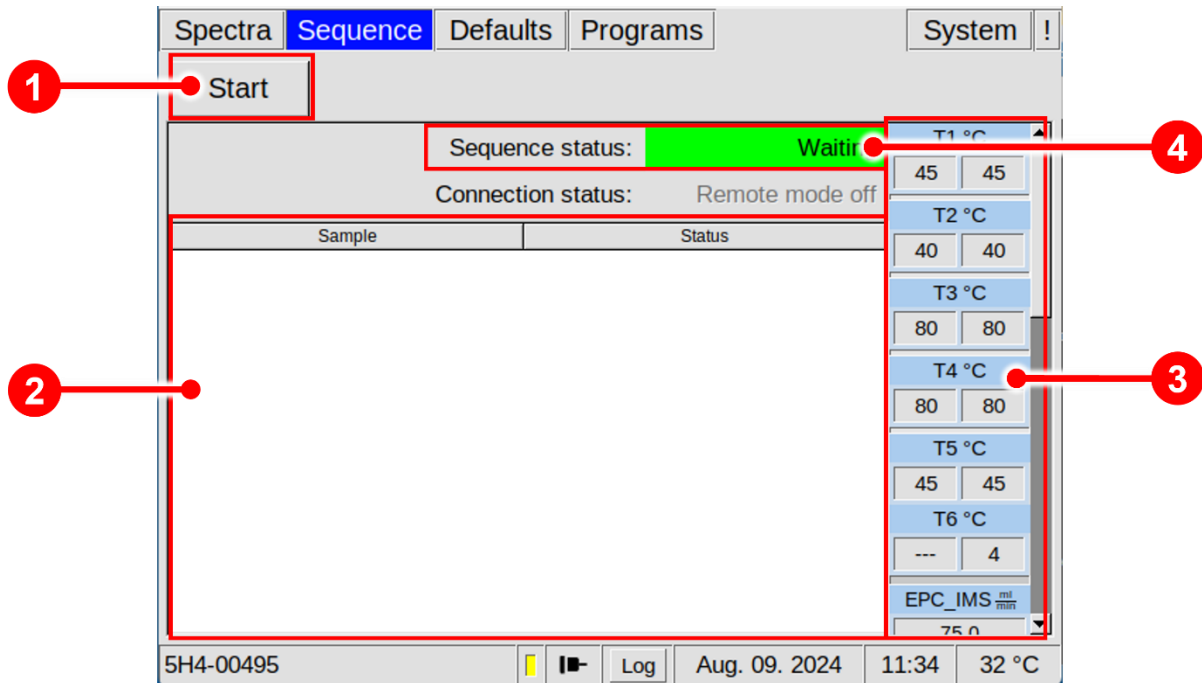

Figure 27: Operating Interface - Sequence Window

1	Start Button	A user created sequence files, created by G.A.S. Sequence Designer Software , can be imported.
2	Information Window	Displays the imported sequence-list. The actual status of each sample is shown.
3	Device Parameter	Displays the current temperature, flow and pressure values.
4	Sequence status	Displays the current sequence status: Possible values are: <ul style="list-style-type: none"> - Waiting - Running - Finished/waiting



INFORMATION!

If the **tftp-protocol** is used for data transmission, the sequence file must be named as **sequence.json**.

After selection, the software will try to import and analyse the sequence file. If the file could be imported and the analysis showed no errors, the sequence will be executed. The following figure shows the execution of a sequence:

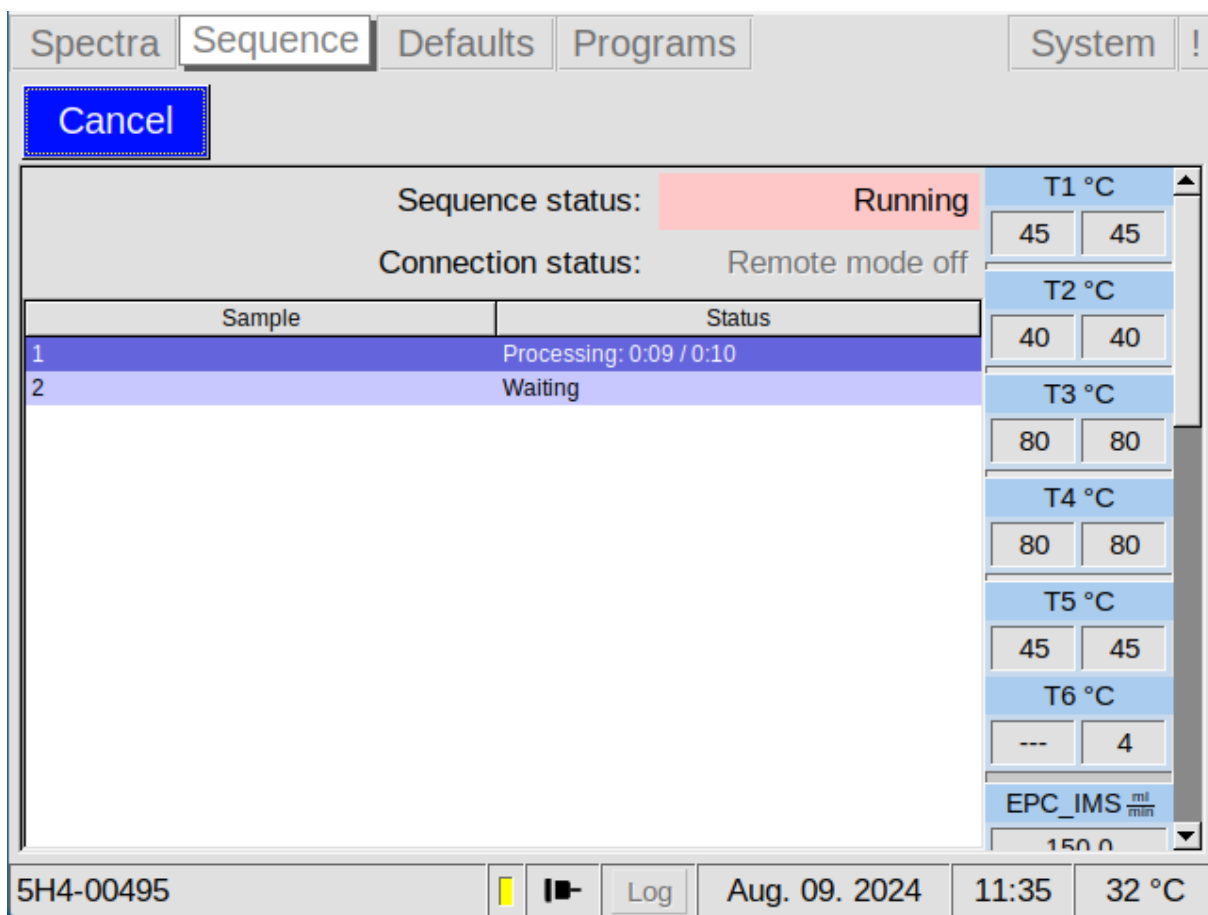

Figure 28: Operating Interface - Sequence Window - Processing

You will see the sequence being processed, one sample after another. The time passed and the total time for each Sample are displayed, showing you the progress. The scrollable area on the right displays the current and the target device parameters for temperatures and flows, as well as some IMS specific values such as voltages and the trigger duration. Clicking on the cancel button will stop the Sequence, but still apply all the After Run Settings. Once the Sequence has finished, all Samples will be marked as done, the last After Run Settings are applied and the software will display the message Execution finished. The system is now ready for further sequences or manual operation.



INFORMATION!

The sequence file must be created with the **G.A.S. Sequence Designer Software**. For detailed Information refer to the **G.A.S. Sequence Designer Software Manual**.



INFORMATION!

From firmware version 4.50, the use of the sequence designer version 1.5 or higher is mandatory.

6.4 Defaults Window

6.4.1 Overview

The Defaults window allows the monitoring and modification of various device component parameters. The electronic pressure controllers (EPC_IMS and EPC_GC) and the heating modules of the device can be controlled (T1 – T6). Further, the averaging and drift voltage polarity can be switched manually.

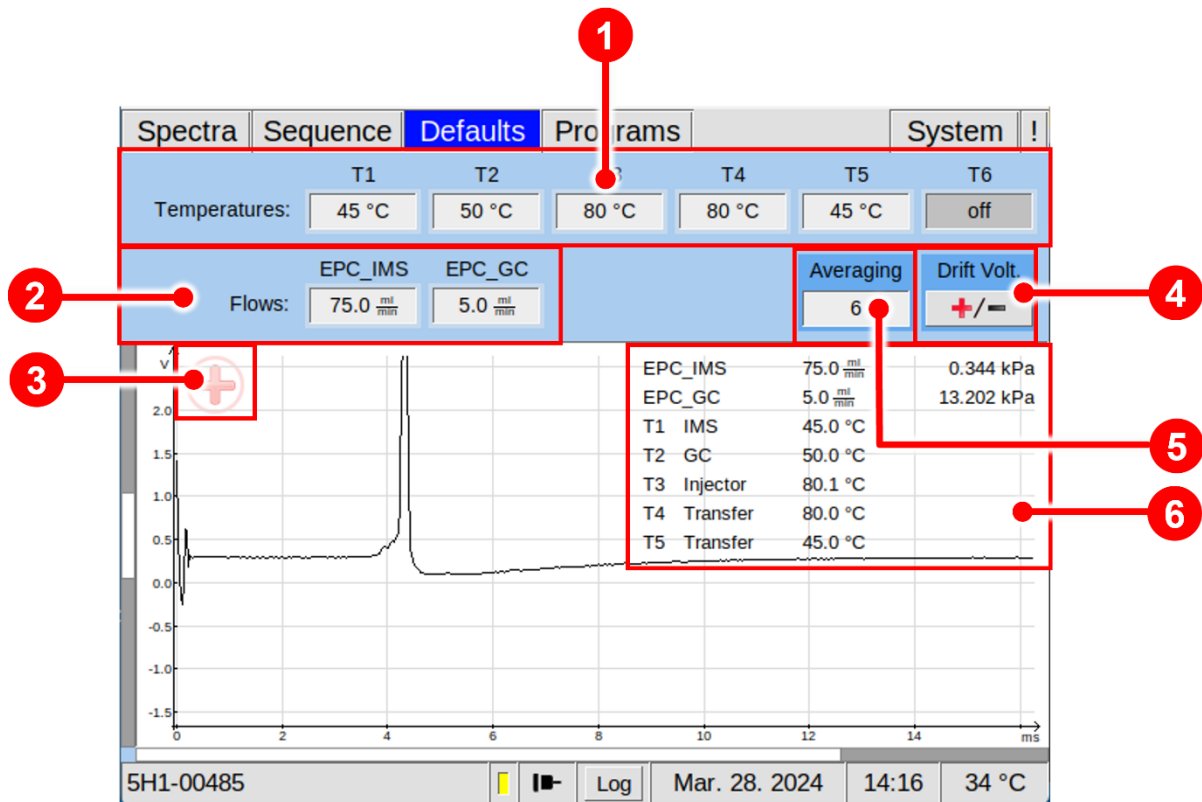

Figure 29: Operating Interface - Defaults Window

<p>1</p>	<p>Temperature setpoint display</p>	<p>The temperature values of the heating modules IMS (T1), Column (T2), Injector (T3), internal Transferlines (T4 and T5) can be set. Temperature module T6 is currently not available. The maximum setable values are 100°C and for Injector (T3) 200°C.</p>
<p>2</p>	<p>Flow setpoint display</p>	<p>The flowrate of drift gas (EPC_IMS) and carrier gas (EPC_GC) can be set. The maximum value for EPC_IMS is 500 ml/min. The maximum value for EPC_GC is 150 ml/min. The working value for EPC_IMS depends of the application measurement. The working value of EPC_GC depends of the application measurement and is influenced by the build-in GC-Column (length, inner diameter).</p>
<p>3</p>	<p>Drift Voltage mode</p>	<p>Displays the current selected drift voltage state (positive / negative).</p>
<p>4</p>	<p>Drift-Voltage button</p>	<p>Drift voltage polarity can be selected and switched (positive / negative).</p>
<p>5</p>	<p>Averaging display</p>	<p>Displays the current average value. The averaging value determines how many raw spectra are averaged to generate one single spectrum as result in the stored measurement file. Modifying the averaging parameter affects the number of recorded spectra per time period. A typical average value is 6. The maximum is set to 99. A value of 0 (Off) disables averaging.</p>
<p>6</p>	<p>Device Parameter</p>	<p>Displays the current temperature, flow and pressure values.</p>

6.4.2 Drift Voltage

The drift voltage can be switched between positive and negative drift voltage mode. One of these two modes may be more suitable for specific substances.

FlavourSpec®25– User Manual

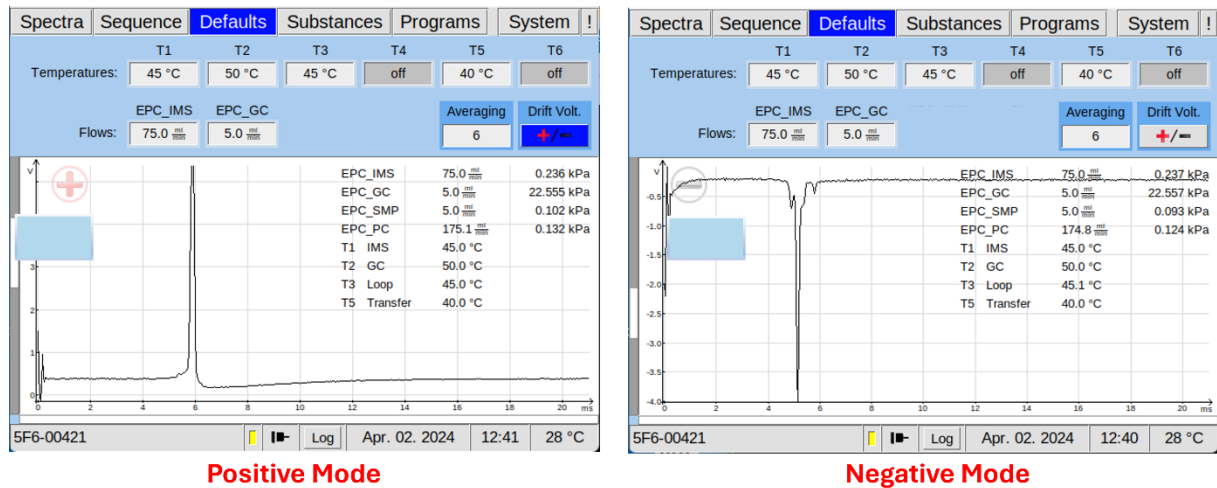

Figure 30: Drift Voltage Windows - positive and negative Mode

6.4.3 Flow setpoints

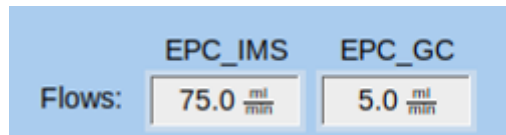

Figure 31: Flow Control (Example)

The flow parameters can be modified in the Flows section of the window.

The flow rates of the drift and carrier gas controlled by the two electric pressure controllers (EPC_IMS and EPC_GC). The maximum value for EPC_IMS is 500 ml/min. The maximum value for EPC_GC is 150 ml/min (Depending on the column used). The set points can be set using these controllers.

6.4.4 Temperatures Controls

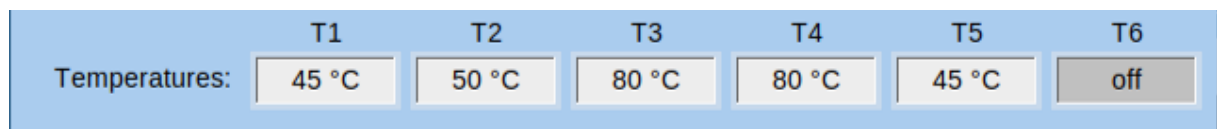

Figure 32: Temperature Control (Example)

The Temperatures parameters of the heating modules can be modified in the Temperatures section of the window. Unused elements are greyed out. The set points of the IMS (T1), the column (T2), the injector (T3) and the inner heated transferlines (T4 and T5) are displayed. The set points can be set using these controllers. The maximum adjustable temperature value for T1, T2, T4 and T5 is 100°C. The maximum

adjustable temperature value for the injector (T3) is 200°C. During the cleaning process the heating modules for T1, T2, T4 and T5 can reach temperatures up to 120°C. These will be displayed as “> 100°C”. Heating modules can be turned off by decreasing the respective value to “off”. During the cleaning process the heating modules for T3, can reach temperatures up to 200°C.

6.5 Programs Window

6.5.1 Overview

In Programs Window user-defined measurement programs can be set and managed.

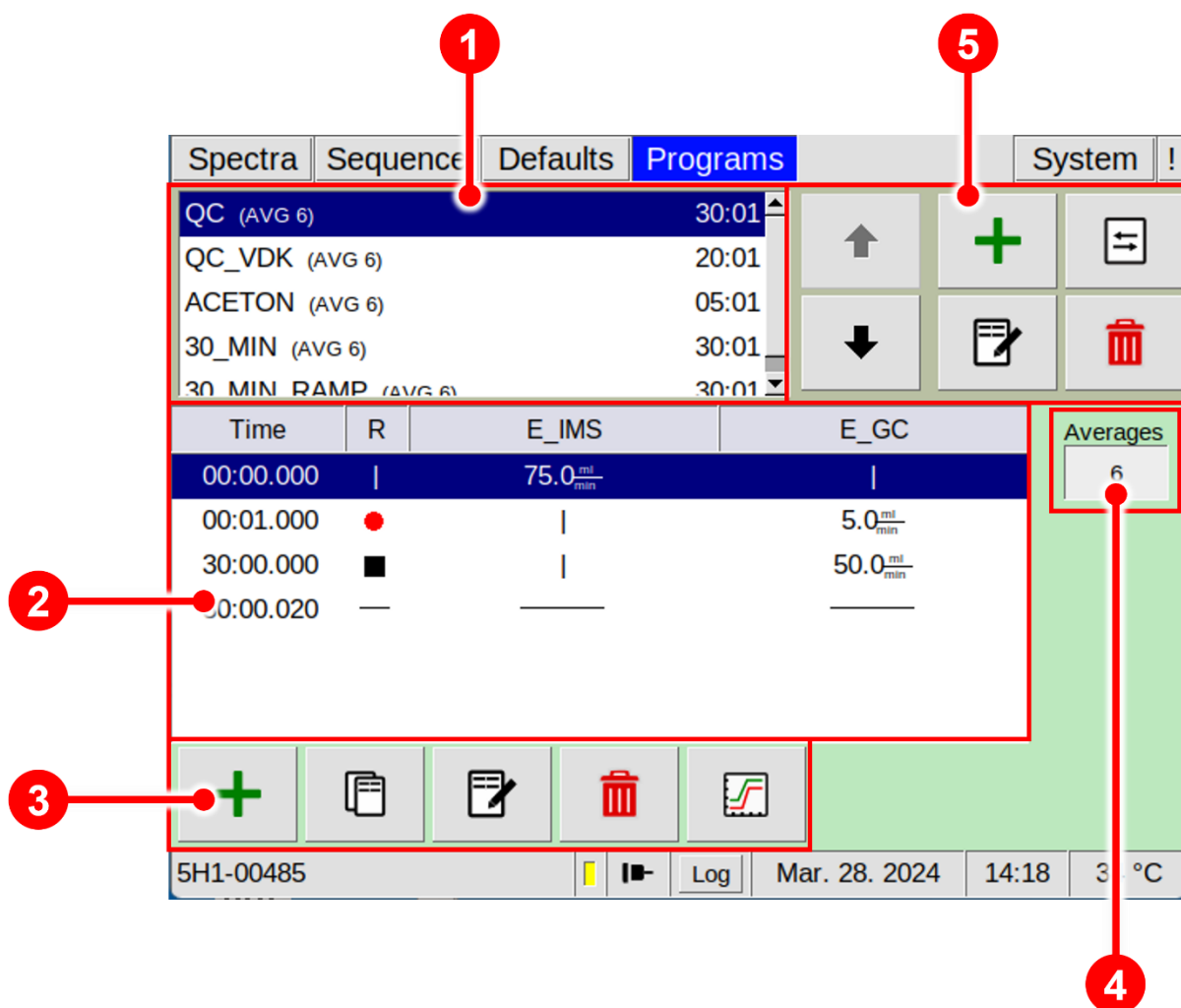
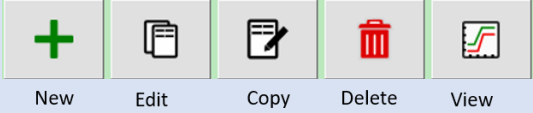
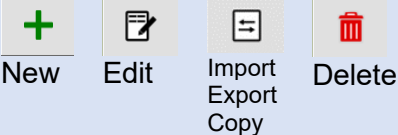

Figure 33: Operating Interface - Programs Window

1	Measurement Program List area	All created programs are listed in this box by name. The highlighted program is selected for execution or modification.
----------	--------------------------------------	---







<p>2</p>	<p>Selected Program area</p>	<p>All instructions of a selected program are listed here in a chronological order. For every device component that can be controlled by a program a separate column is displayed.</p>						
<p>3</p>	<p>Program Action Control Panel</p>	<p>Buttons for creating, changing or deleting actions of the selected program.</p> 						
<p>4</p>	<p>Average Settings</p>	<p>Average of the current selected program can be set. The current average is appended to the name of the measurement program.</p> <p>The following settings are possible:</p> <table border="1" data-bbox="807 864 935 1104"> <tr> <td>Averages</td> <td>off</td> </tr> <tr> <td>Averages</td> <td>6</td> </tr> <tr> <td>Averages</td> <td>99</td> </tr> </table> <p>No averaging set (off) Recommended standard averaging (6) Possible maximum averaging (99)</p>	Averages	off	Averages	6	Averages	99
Averages	off							
Averages	6							
Averages	99							
<p>5</p>	<p>Program Control Panel</p>	<p>Buttons for creating, changing or deleting actions of the selected program</p> 						

6.5.2 Create Measurement Programs

The Measurement Program List window displays all measurement programs currently existing. The measurement programs list can contain **up to 100 entries**. The current average value is part of the program name. The selected program can be edited.



Figure 34: Measurement Control Panel

 Up	<p>The list order of the selected program can be changed stepwise upwards.</p>
 Down	<p>The list order of the selected can be changed stepwise downwards.</p>
 New	<p>The New button which will open a keyboard window for entering the program name.</p>
 Edit	<p>By pressing the Edit button the program name for the selected entry can be edited into a keyboard window.</p>
 Import Export Copy	<p>By pressing this button a new appears. Programs can be imported, exported and copied</p>
 Delete	<p>By pressing the Delete button the program of the selected program will be deleted.</p>

In the **Averages** field the average of the current selected program can be set. It is appended to the name of the measurement program.

6.5.3 Edit Measurement Programs

Each program consists of a list of chronological ordered steps, so called actions. The Selected Program Window displays the list of actions for the currently selected program. Each row in this list represents a step in the measurement program in which various changes to the device components are made.

	Time	R	E_IMS	E_GC
5	00:00.000		75.0 $\frac{ml}{min}$	
	00:01.000	•		5.0 $\frac{ml}{min}$
	30:00.000	■		50.0 $\frac{ml}{min}$
6	30:00.020	—	—	—

Figure 35: Selected Program Window

- 1 **Time:** Time point of action start
- 2 **R:** Start / Stop recording spectra (rec • / stop ◐)
- 3 **E_IMS:** Flow rate control for drift gas (0- 500 ml/min)
- 4 **E_GC:** Flow rate control for carrier gas (0- 150* ml/min)
- 5 Selected program action line
- 6 End of Program line

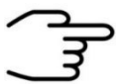

INFORMATION!

* The EPC_GC maximum flow (carriergas) of 150 ml/min is restricted by the installed column dimensions. It only can be attained if the standard column is installed (15 m length, 0.53 mm inner diameter). **Using columns with other dimensions can limit the EPC_GC maximum flow.**

A value here determines the new state of the respective device component. A vertical line “|” indicates that the respective device component is not involved in this action.

The last row in this action list contains horizontal lines only. It indicates the end-of-program. The point of time of this end-of-program marker can be increased. This determines the duration of the program run.

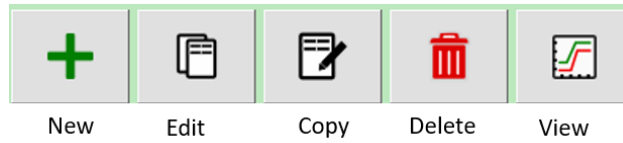





Figure 36: Program Action Control Panel

With the buttons in the Selected Program Window Control Panel the currently displayed program can be created, modified, deleted and viewed. A newly created action is positioned after the currently selected action. Pressing the **Copy** button copies the selected action and orders the copy behind the selected action. To maintain the chronological order of the actions the system may rearrange the actions by ordering them according to their numbers later on. By pressing the **Del** button the currently selected action is deleted.

Pressing the **Edit** button or the **New** button opens the Edit Action dialogue.

 New	The New button which will open a keyboard window for entering the program name.
 Edit	By pressing the Edit button the program name for the selected entry can be edited into a keyboard window.
 Delete	By pressing the Delete button the program of the selected program will be deleted.
 View	By pressing View button shows the graphical EPC_ IMS- and EPC_GC flow of the currently selected program.

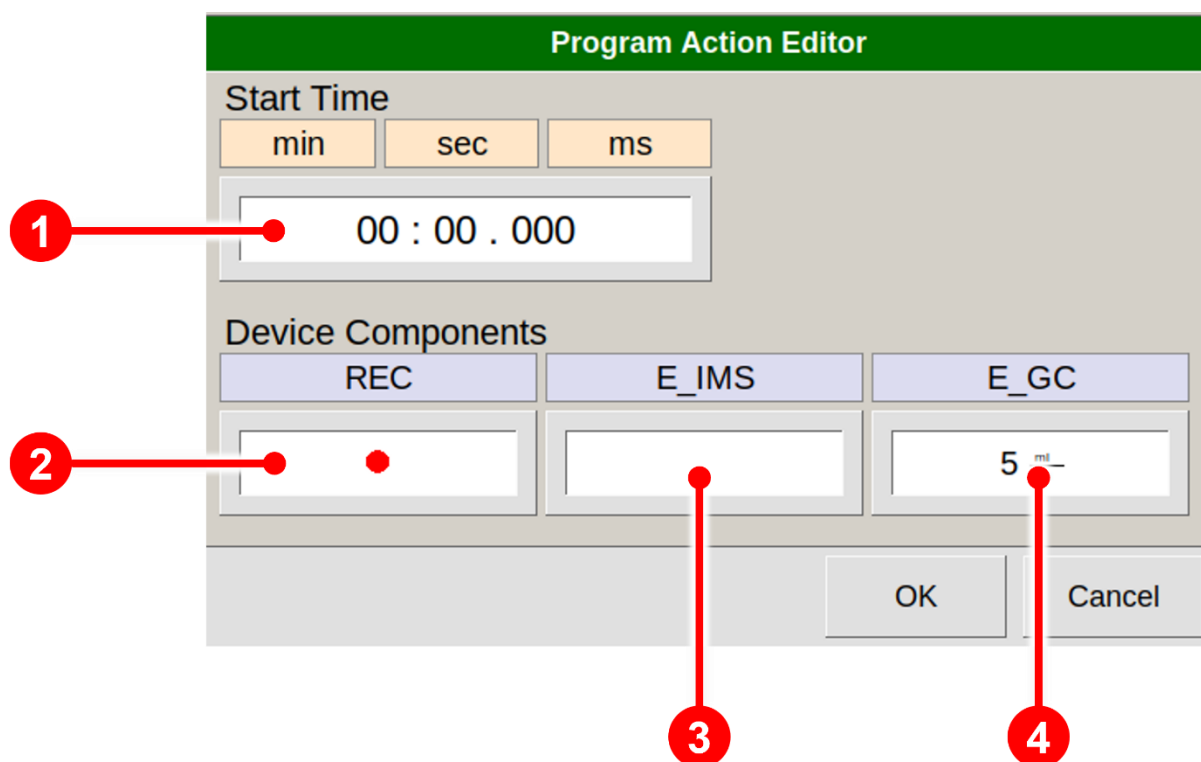

Figure 37: Program Action Editor

1	Start Time	Time point of action start.
2	Recording	Start / Stop recording spectra (rec ● / stop ■).
3	Electronic pressure control IMS	Drift gas flow rate ramp set point (0–500 ml/min).
4	Electronic pressure control GC	Carrier gas flow rate ramp set point (0–150 ml/min).

Pressing the **View** shows a graphical view of the created program.

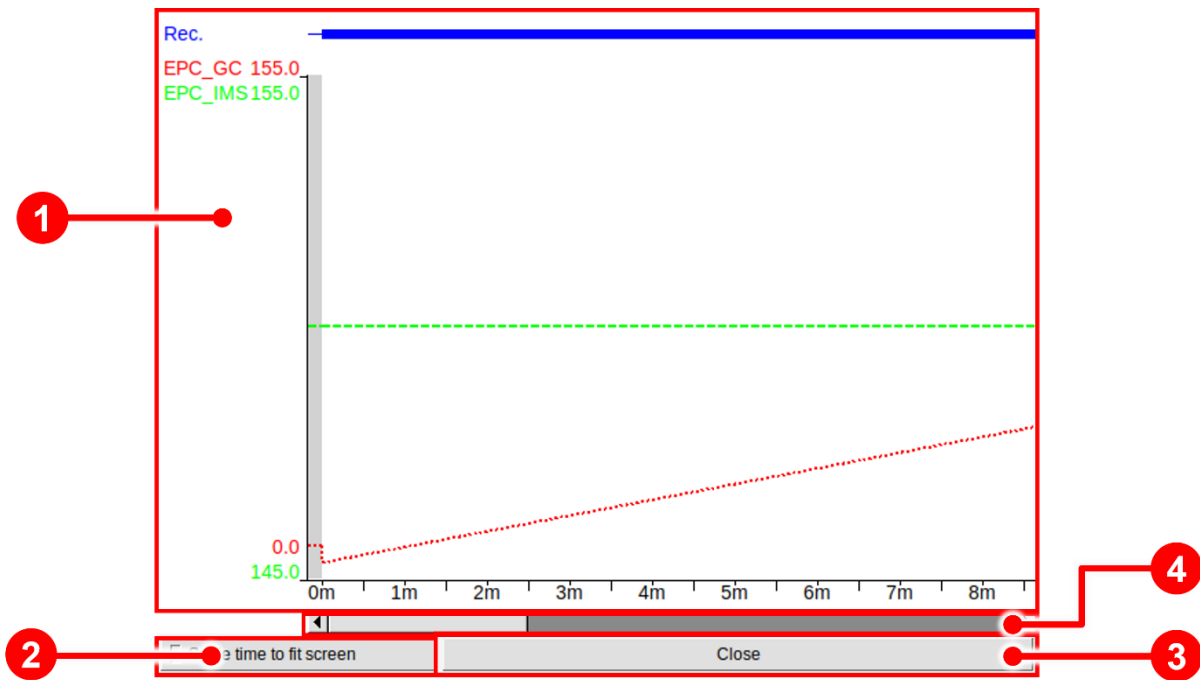

Figure 38: Program Action View

1	Graphical View Display	Displays the Program parameter EPC_IMS, EPC_GC and REC.
2	Scale time to fit screen Button	Adjusts the display to the screen.
3	Close	Closes the graphical view .
4	Scrollbar	Shifts the current time view area.

6.5.4 Flow Ramps

The flow rate set points in a measurement program determine the target flow rates at the specified time index. If set points differ from the default flow rate or varying flow rate set points are specified in a program, the course of the actual flows will be conducted as a linear ramp of the flow. Starting point of the ramp is the latest set point. If no earlier set point is given the ramp starts with program initialization using the default set point.



INFORMATION!

If the flows in the default setting deviate from the start values in the program, the user is alerted by a visual signal (start button flashes in the Spectra window and in trigger mode).

An **exemplary program** using a dynamic flow rates is visualized in the following figure:

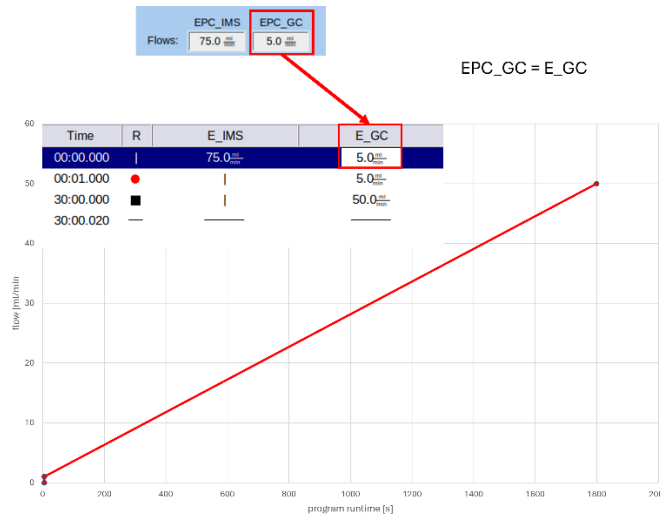

Figure 39: Flow Ramps

The E_GC (carrier gas flow) value is initially set to 5 ml/min. Between runtime 1 sec – 30 min the flow is linearly increased to the target value 50 ml/min.



INFORMATION!

Before starting a measurement make sure that the highest flow set points can be achieved. Note that large changes in the flow set points will need finite time.



INFORMATION!

Please make sure that default values of EPC_IMS and EPC_GC (Default window) corresponds with the start value of E_IMS and E_GC in the program, otherwise the reproducibility of the measurement cannot be guaranteed.



INFORMATION!

Make sure that the EPC_GC start pressure is reached again at the beginning of the next program run.

RECOMMENDATION:

Make sure that the initial flow at EPC_GC is kept constant during the first 60 seconds after injection before starting a flow ramp, especially when a low flowrate is chosen.

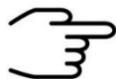

INFORMATION!

GC normalization of retention times to retention indices for substance identification is based on measurements of the retention times of known compounds (e.g. from the custom ketones standard). This normalization can be done, for example, using the VOCal software.

Between the measured points the retention indices are interpolated. It is therefore recommended to set a uniform slope of the carrier gas flow ramp to avoid flow changes or retention index jumps.



INFORMATION!

For detailed Information about substance identification refer to the [VOCal Tutorials](#).

6.6 System Window

In the System Window system specific information are displayed and can be set.

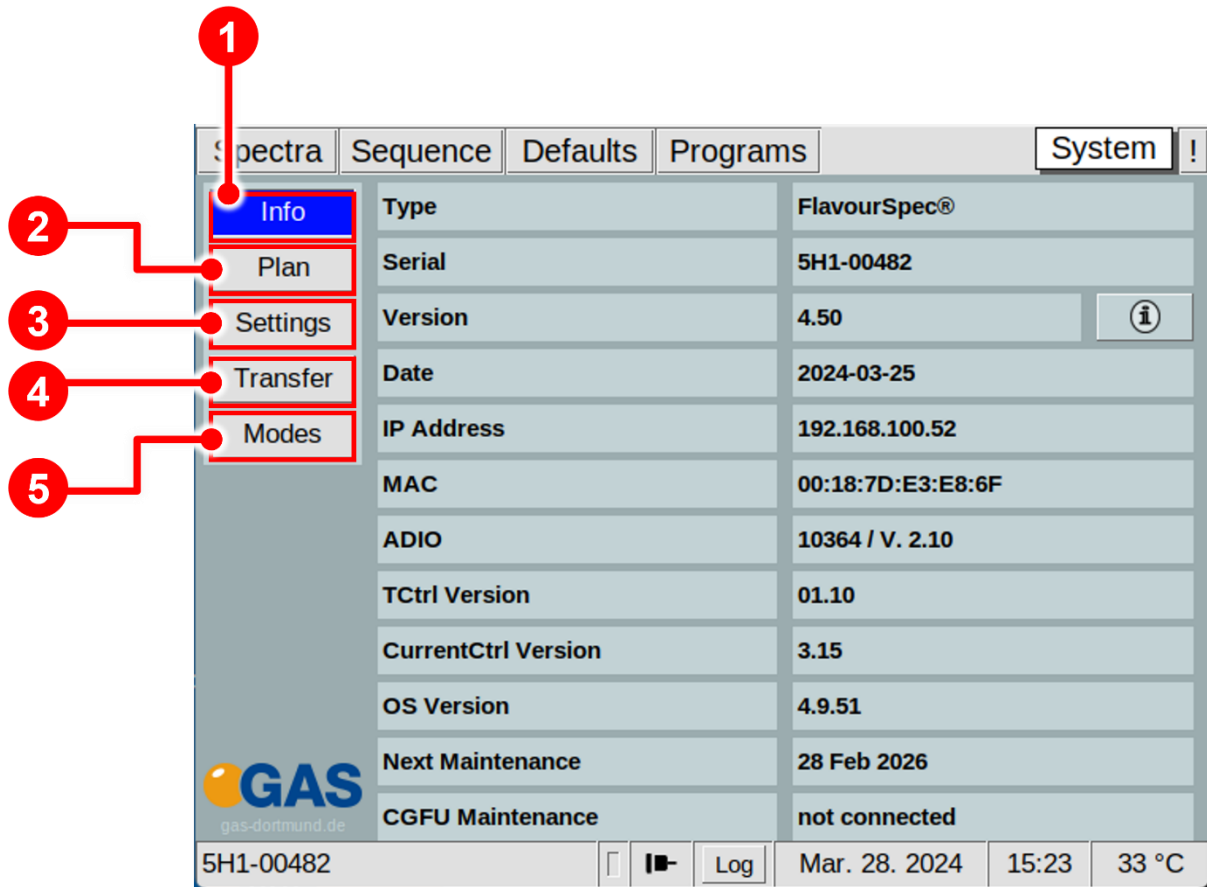

Figure 40: Operating Interface - System Window

1	Info Button	Displays the System Information Window.
2	Plan Button	Displays the Device Plan Window.
3	Settings Button	Displays the Settings Window. Various device parameter like Export Setting, Livedata output, Device attributes can be set.
4	Transfer Button	Displays the current data transfer settings. Data transfer settings can be set.
5	Modes Button	Special application modes can be set.

6.6.1 System Info Window

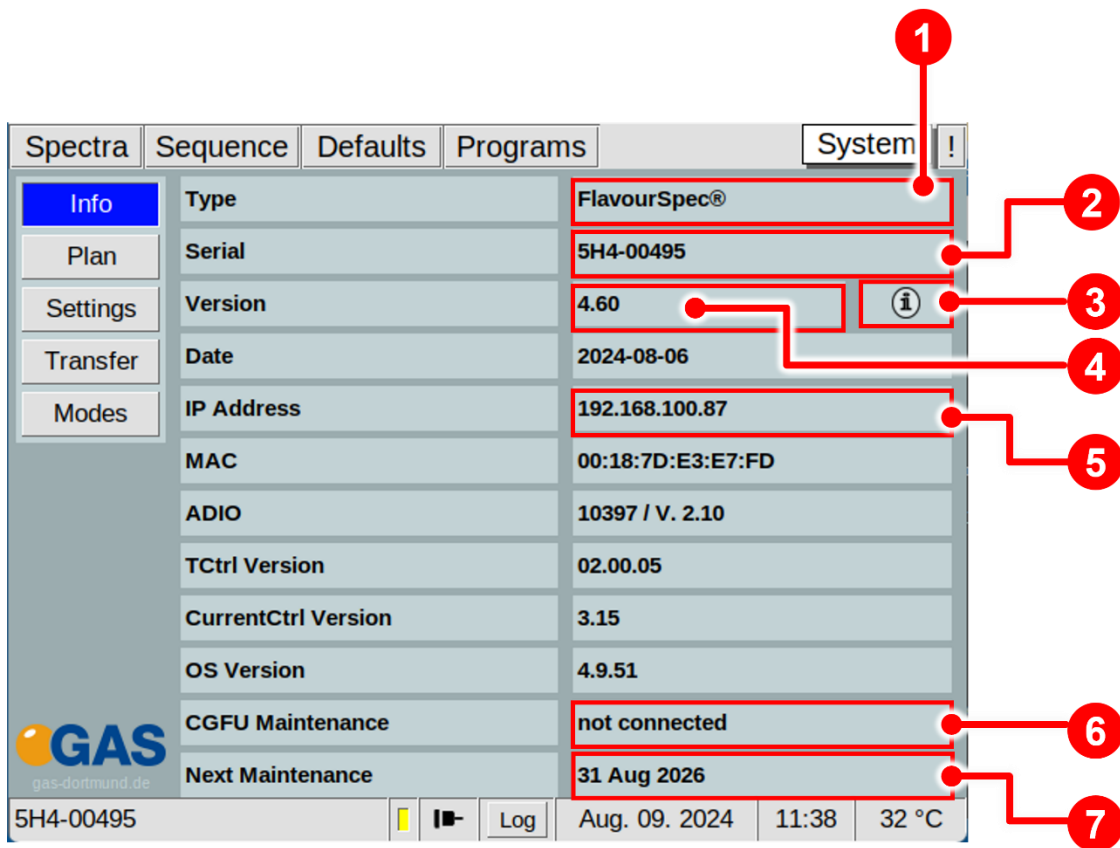

Figure 41: Operating Interface - System Info Window

1	Type	Device type.
2	Serial	Device Serial Number.
3	Information	License Information
4	Version	Current Firmware Version.
5	IP Address	Displays the current IPv4-Address.
6	Next Maintenance	Displays the next maintenance date.

6.6.2 System Plan Window

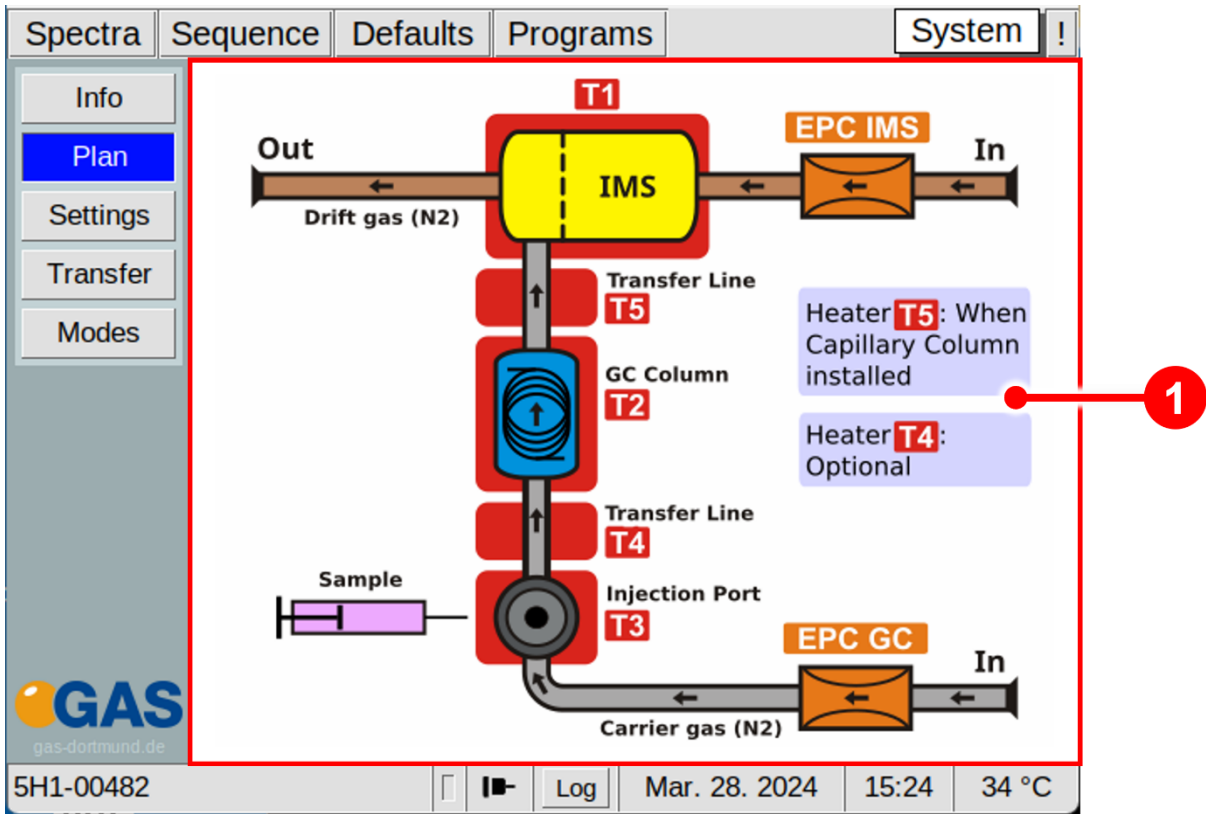

Figure 42: Operating Interface - System Plan Window

1	Plan	Displays an overview plan of the device.
----------	-------------	--

6.6.3 System Settings Window

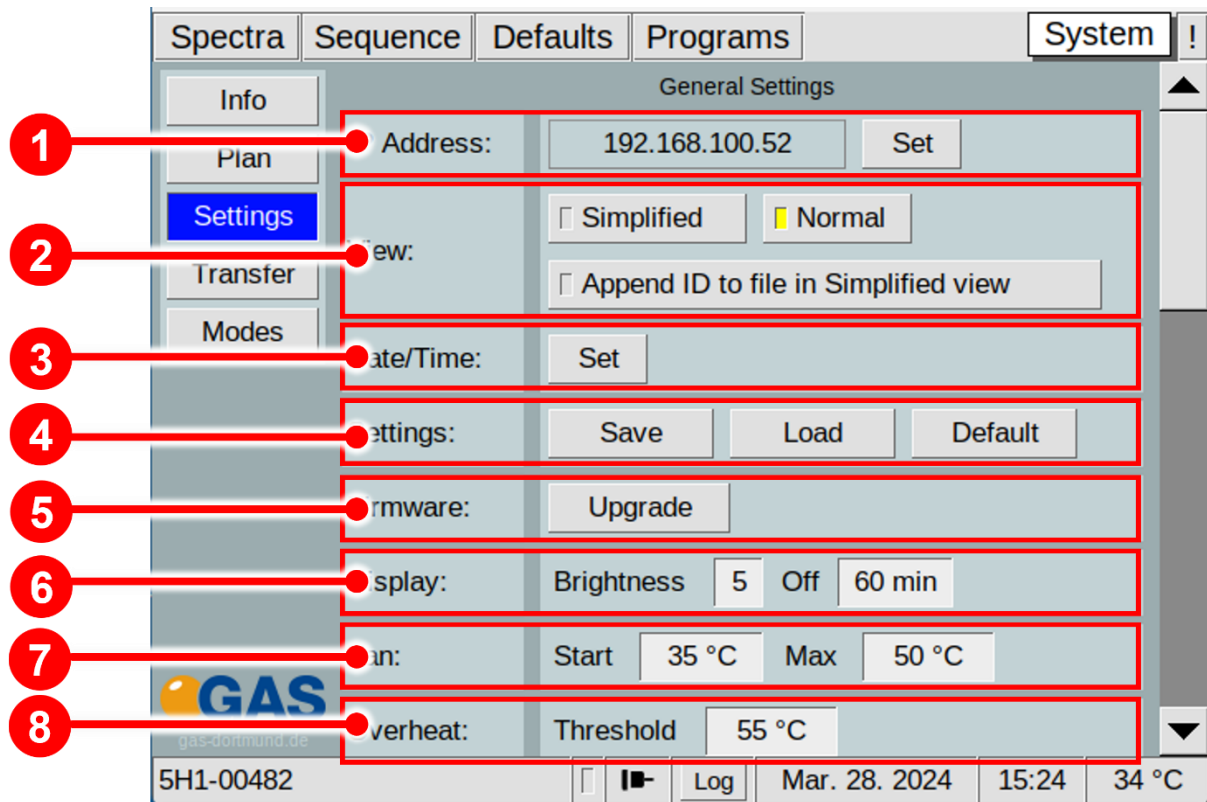

Figure 43: Operating Interface - System Settings Windows 1

1	IP Adress	Displays the current set IPv4-Adress of the device. With Set button the IPv4-adress can be set.
2	View	Toggles between Simplified and Normal view. Activating the Append ID to file in Simplified view button stores the entered ID in the metadata of the measurement.
3	Date/Time	With Set button the date and time can be set.
4	Settings	<p>Save button: The system settings can be saved to a connected USB volume.</p> <p>Load button: The system settings can be loaded from a connected USB volume.</p> <p>Default button: Resets all system settings to factory default values. All measurement-programs and substance-entries set by user will be deleted.</p>

5	Firmware	With Upgrade button a firmware upgrade can be performed from a connected USB volume.
6	Display	The display brightness and screen-saver time-out can be set.
7	Fan	The behaviour of the cooling fan can be set. When the temperature inside the device reaches the temperature in the field 'Start', the cooling fan switches on. The power of the cooler fan is increased up to the desired temperature of the value in the field 'Max'.
8	Overheat	The threshold temperature for the overheat alarm can be set.

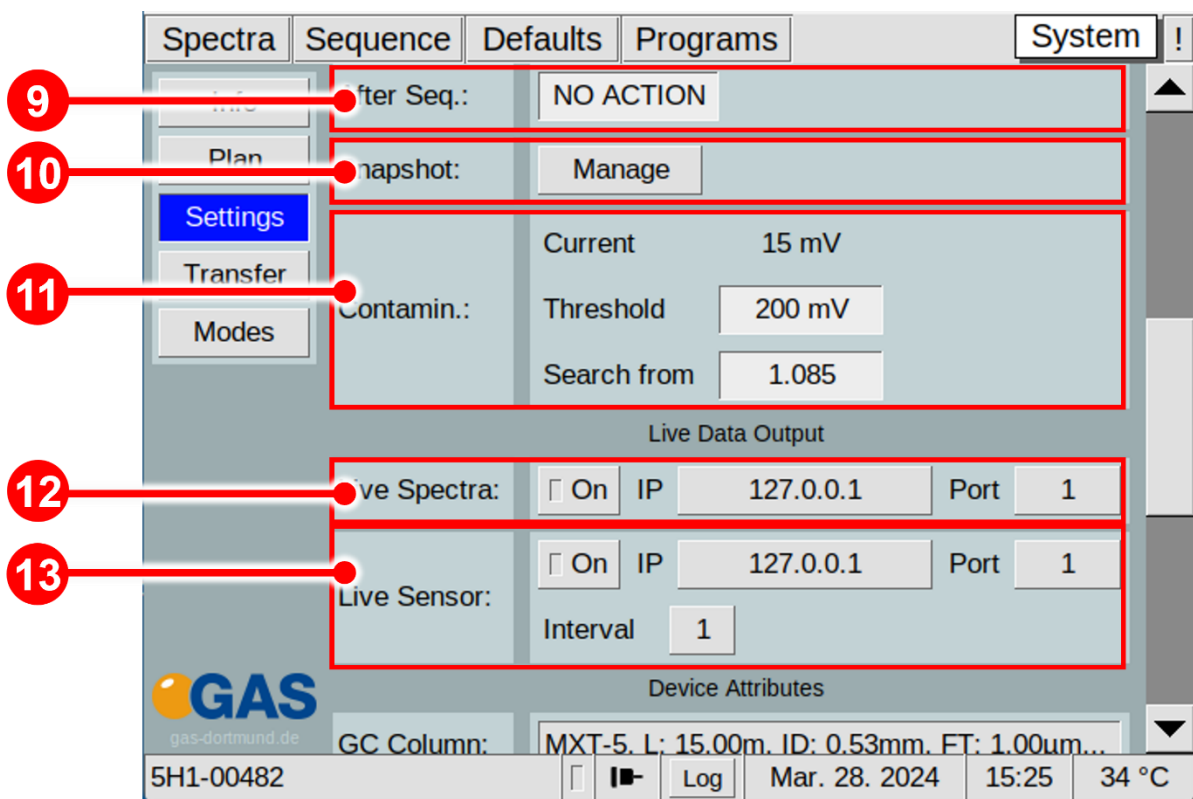

Figure 44: Operating Interface - System Settings Window 2

9	After Seq.:	The After Sequence Action can be set. The following options are available: No Action , Cleaning , Standby , Custom .
----------	--------------------	--

<p>10</p>	<p>Snapshot</p>	<p>The Manage button opens the snapshot window. User-specific target values can be set. A new snapshot can be recorded or can be imported.</p> <p>Snapshot is a new function to allow automatic instrument performance checking.</p>
<p>11</p>	<p>Contamin</p>	<p>Define the automatic search area for contamination. The search window can be defined by setting the Threshold (signal level in mV which is recognised as a contamination) and the start of the search in the drift time spectrum given as RIP relative proportional factor.</p> <ul style="list-style-type: none"> • Current: Shows the currently detected contamination shows the currently detected contamination. • Threshold: The set value from which an error is triggered. <p>Search from: The RIP-relative starting position of the search.</p>
<p>12</p>	<p>Live Spectra:</p>	<p>Prepared for further use! Currently not in function!</p>
<p>13</p>	<p>Live Sensor:</p>	<p>The settings for Live Data communication with G.A.S. Sequence Designer Software can be set. For detailed Information refer to the G.A.S. Sequence Designer Software Manual.</p>



INFORMATION!

The device is delivered with an acceptance snapshot. This snapshot defines the system performance during device acceptance and is used to assess measurement readiness. Any deviations from this are displayed in the Error Information Window.

The default values can be adjusted by the customer.

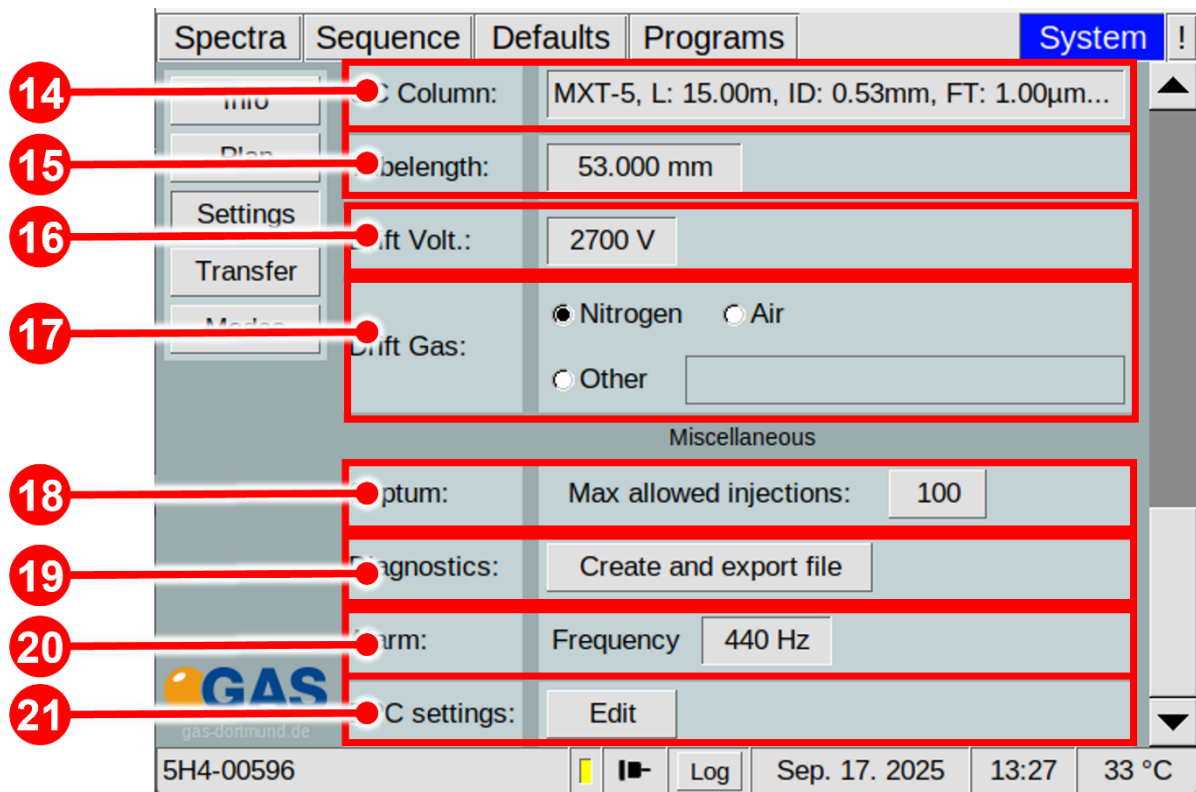

Figure 45: Operating Interface - System Settings Windows 3

14	GC Column:	Input filed for Column ID. The Column data editor window open to enter the Column-ID. This data is stored in the metadata of the measurement.
15	Tubelength:	Setting the length of the drift tube.
16	Drift Volt.:	Setting of the applied drift voltage.
17	Drift Gas:	Selection field for operating gas type. The value is stored with measurement file.
18	Septum	The user-specific defined number of injections can be set (default: 100).
19	Diagnostics:	With Create and export file button an encrypted diagnostic file is created for diagnostic purposes by G.A.S..
20	Alarm:	The frequency of the warning sound can be set.

21

EPC Settings:

Gas type for EPC_IMS and EPC_GC can be set.



INFORMATION!

The screen interface can be switched from English to Chinese as of firmware version 4.70.

The language can be changed in the system window line Language.

This line is only available for systems for the Chinese market.

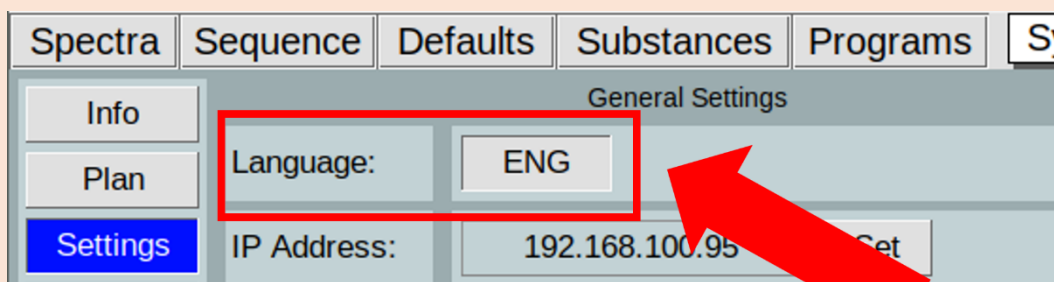

6.6.3.1 Snapshot Window

The instrument performance and status can be monitored using recorded snapshots. It is an automatic comparison of current instrument settings versus the operator defined target settings which helps the operator to assess the readiness of the system for starting a measurement. This automatic monitoring can recognize among other a System contamination, insufficient gas quality or system leaking. For this purpose, the following parameters are constantly cross-checked against the target-settings:

- The carrier gas pressure – EPC_GC pressure (kPa)
- The height of the Reaction-Ion-Peak (RIP) - Rip-height (V)
- The position of the Reaction-Ion-Peak (RIP) normalized to normal pressure – Rip Pos at 101.33 kPa (ms)
- The full width at half maximum of the Reaction-Ion-Peak - FWHM (ms)
- The temperature values T1-T6
- The gas flow and pressure of drift gas (EPC_IMS) and carrier gas (EPC_GC)

The user can change the default factory settings for his needs. Error messages are displayed in the Error Information Window.

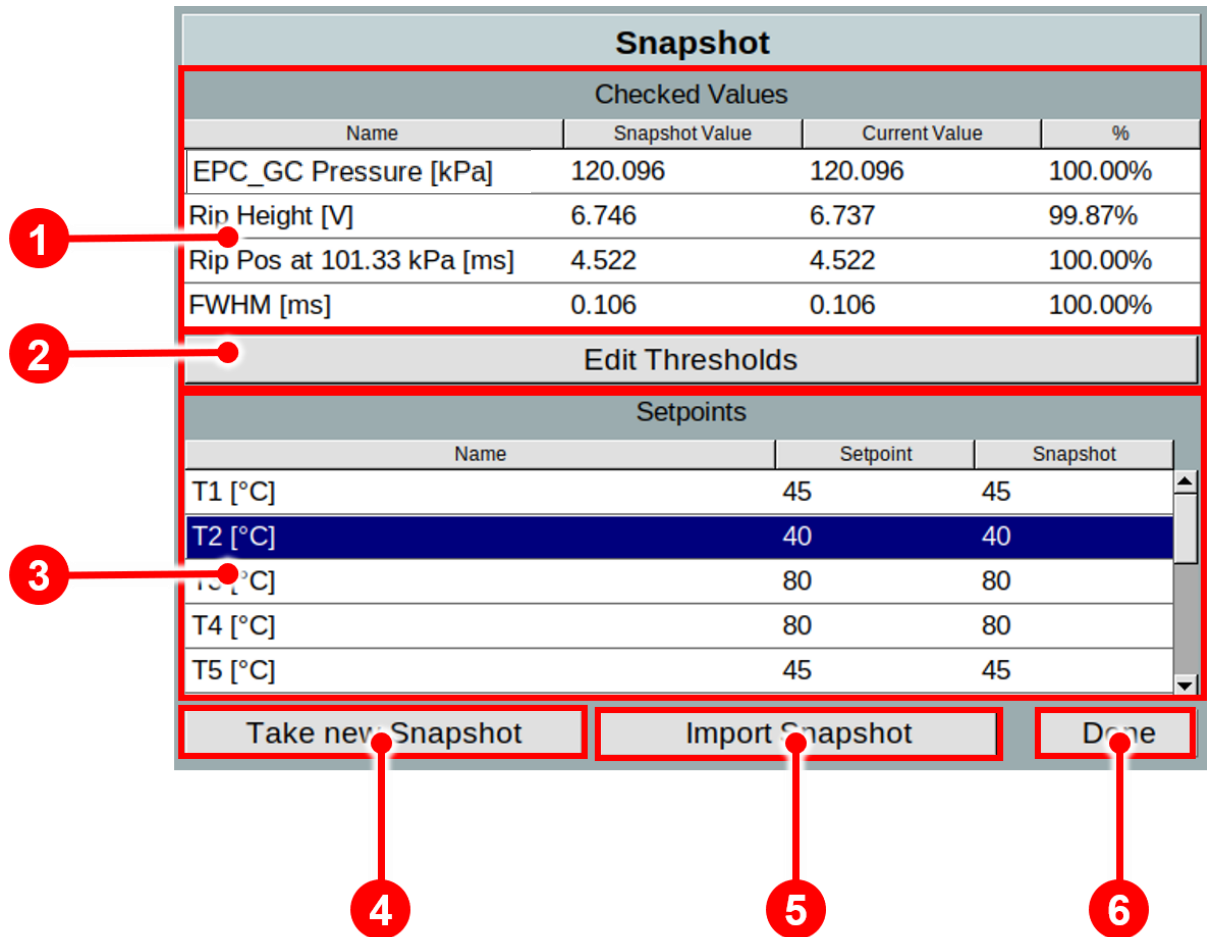

Figure 46: Operating Interface – Snapshot Window

1	Checked Values area	The checked Snapshot values (EPC_GC Pressure; Rip Height, Rip-Position at 101,33 kPa, Rip-half-value width FWHM) are displayed.
2	Edit Thresholds	The selected Snapshot values (EPC_GC Pressure; Rip Height, Rip-Position at 101,33 kPa, Rip-half-value width FWHM) can be edited.
3	Setpoints Area	Display of the current setpoints and the corresponding snapshot values.
4	Take new Snapshot Button	Take a new snapshot of the current system status.
5	Import Snapshot Button	Import a Snapshot-file with prepared values by G-A.S.

6	Done Button	Closes the snapshot window
----------	--------------------	----------------------------

6.6.3.1.1 Snapshot window in detail

The system is delivered with standard limits for EPC_GC-Pressure, RIP-Height, RIP Position at 101.33 kPa and FWHM. The upper and lower limits of these parameters can be adjusted by the customer.

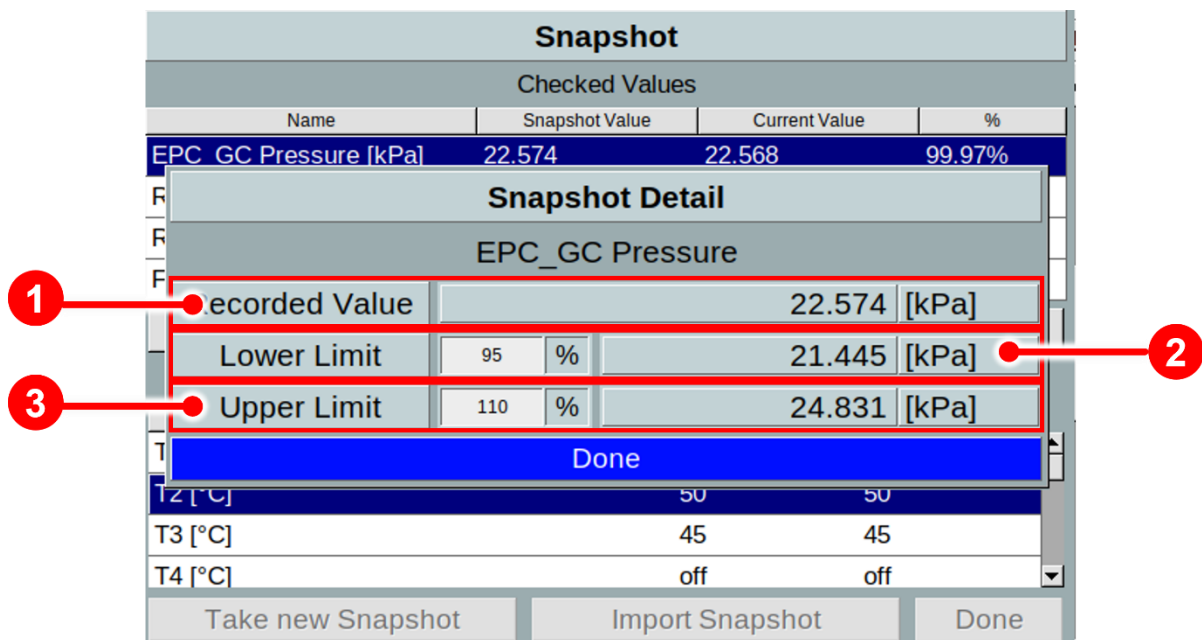

Figure 47: Operating Interface – Snapshot Window in detail (example EPC_GC pressure)

1	Recorded Value	Displays the current recorded snapshot value (Example EPC_GC pressure).
2	Lower Limit	The lower limit of the current recorded snapshot value (Example EPC_GC pressure) is displayed. This limit can be specified by the user.
3	Upper Limit	The upper limit of the current recorded snapshot value (Example EPC_GC pressure) is displayed. This limit can be specified by the user.

Factory default limits

Name	Lower limit (%)	Upper limit (%)
EPC_GC-Pressure (kPa)	95	110
RIP Height (V)	80	150
RIP Position at 101.33 kPa (ms)	95	105
FWHM (ms)	80	120



INFORMATION!

The device is delivered with an acceptance snapshot. This snapshot defines the system performance during device acceptance and is used to assess the readiness for measurement. Any deviations from this are displayed in the Error Information Window. **The default values can be adjusted by the customer.**

6.6.3.2 GC Column parameter setting

The input of the column identifier follows a defined nomenclature. This should be noted, as it is necessary for the evaluation with VOCal-Software.

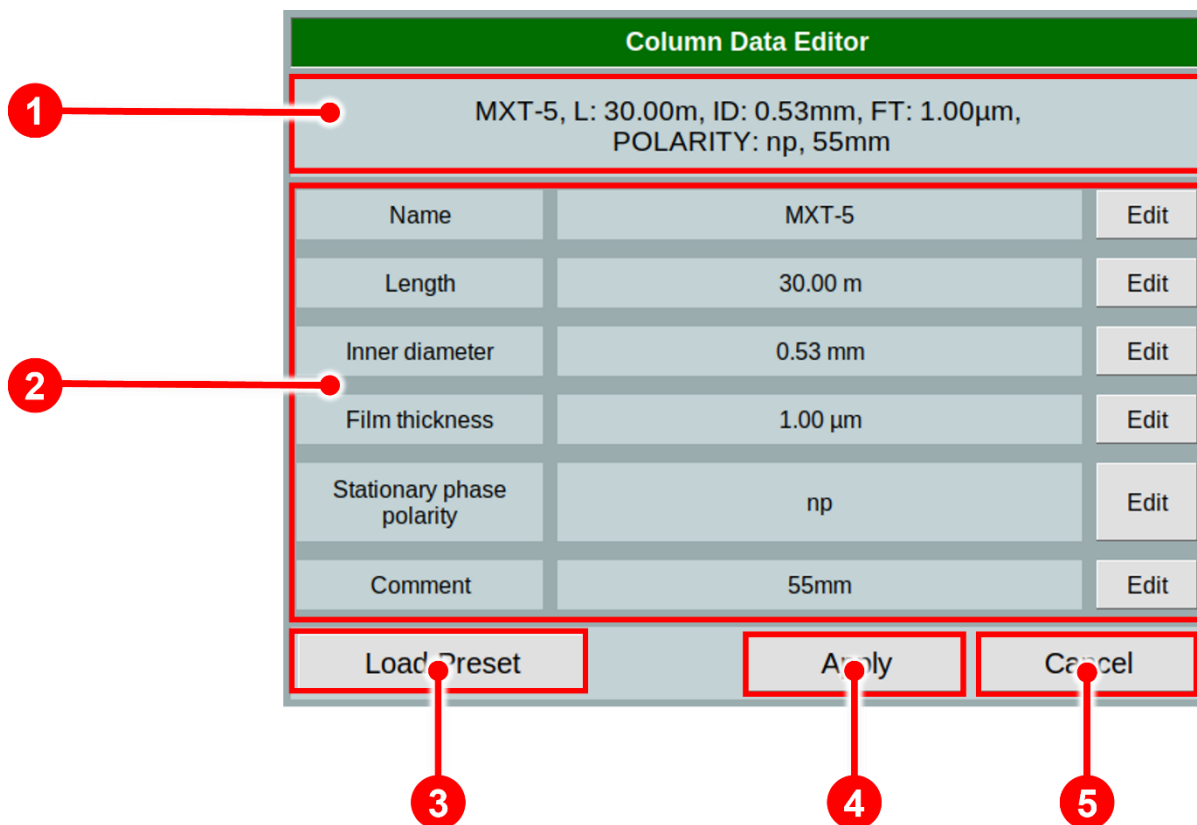

Figure 48: Operating Interface – Column Data Editor Window

<p>1</p>	<p>Column display windows</p>	<p>Displays the current GC-column.</p>
<p>2</p>	<p>Parameter input window</p>	<p>The following column parameters can be set manually:</p> <p>Name (Max. 30 characters)</p> <p>Length (Min. 0.05 m – Max. 100.00 m)</p> <p>Inner diameter (Min. 0.01 mm – Max. 10.00 mm)</p> <p>Film thickness (Min. 0.01 µm – Max. 8.00 µm)</p> <p>Stationary phase polarity (polar, non-polar, other)</p> <p>Comment (Max. 30 characters)</p>
<p>3</p>	<p>Load Preset</p>	<p>A standard selection of GC columns can be selected.</p>

4	Apply	The selected parameters are applied.
5	Cancel	The selection is canceled. The selected parameters are not applied.

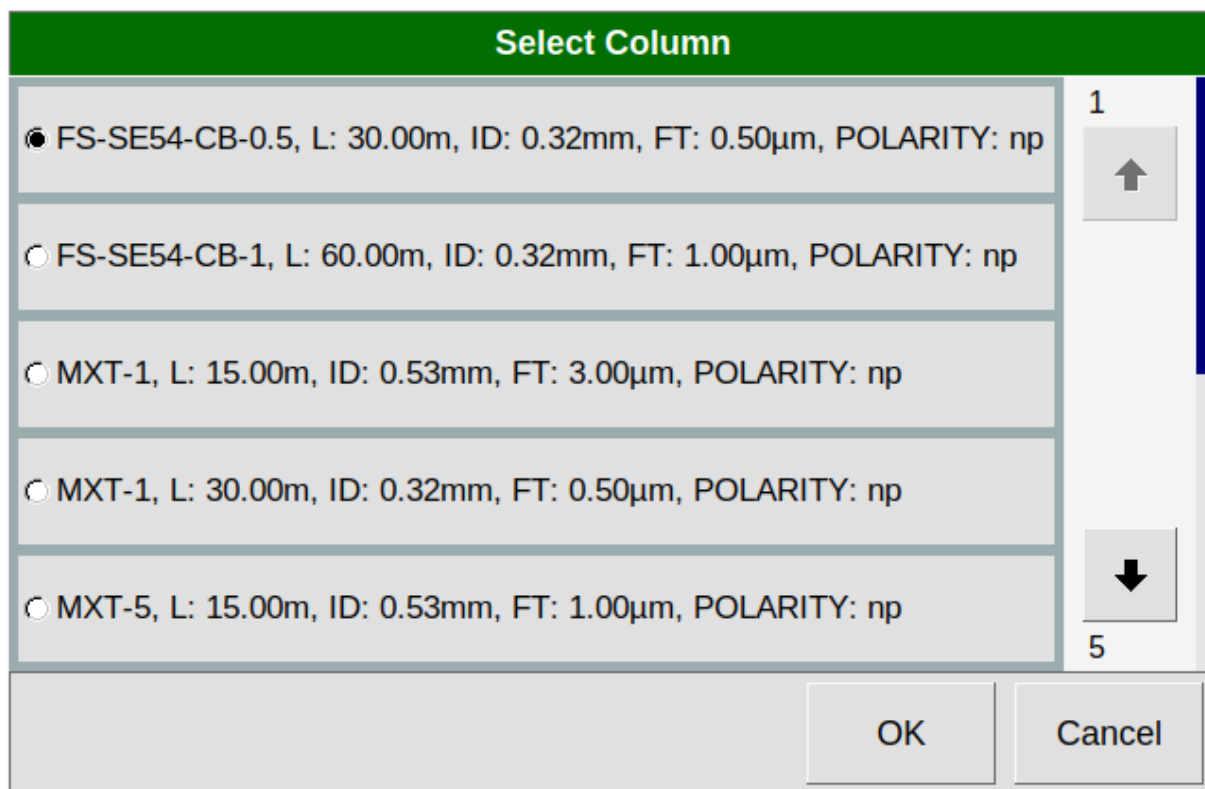

Figure 49: Column Preset Window

6.6.3.3 EPC parameter setting

The gas type used for drift gas (EPC IMS) and carrier gas (EPC GC) can be set here by the user. The default setting is nitrogen. The gas types usually used in ion mobility spectrometry are nitrogen and air in quality level 5.0

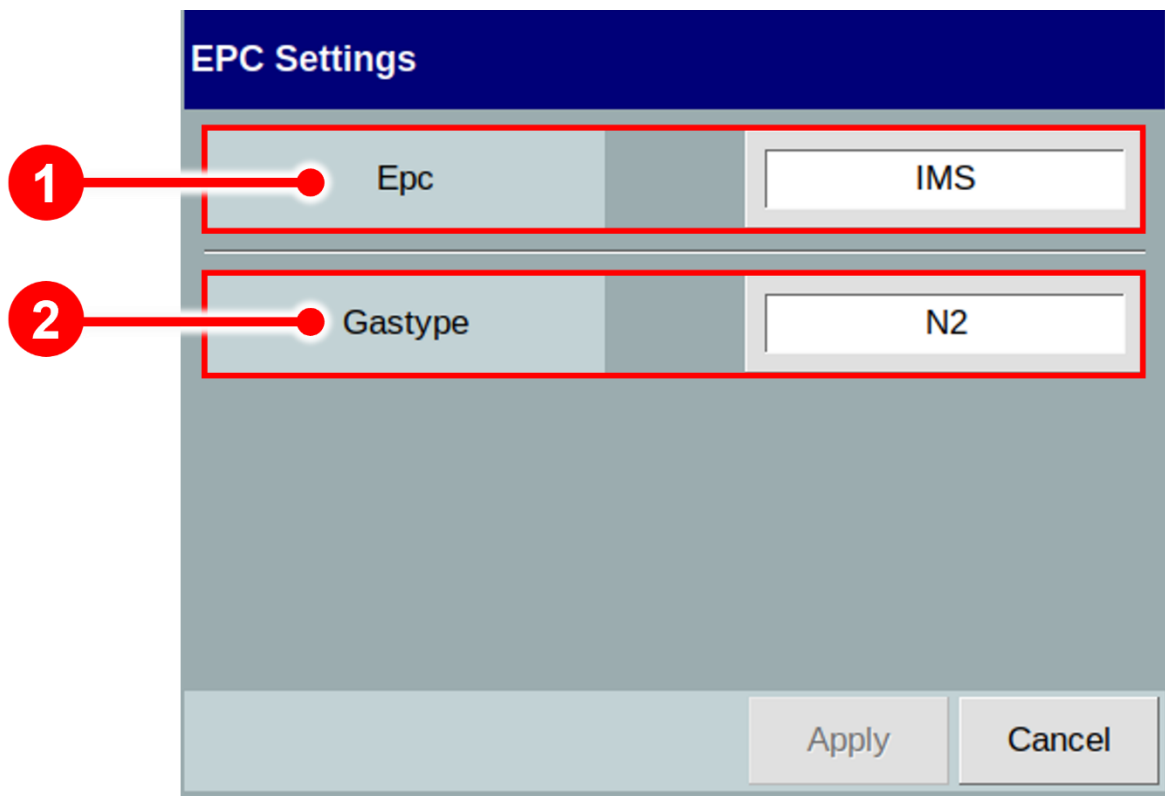

Figure 50: EPC Settings Window

1	EPC	The EPCs installed in the device can be selected.
2	Gas type	<p>A gas type can be assigned to the currently selected EPC. The following gas types are available:</p> <ul style="list-style-type: none"> • Air • Nitrogen (N2) • Helium (He) • Argon (Ar)

- Oxygen (O2)
- Carbon dioxide (CO2)

6.6.3.4 Simplified View Window

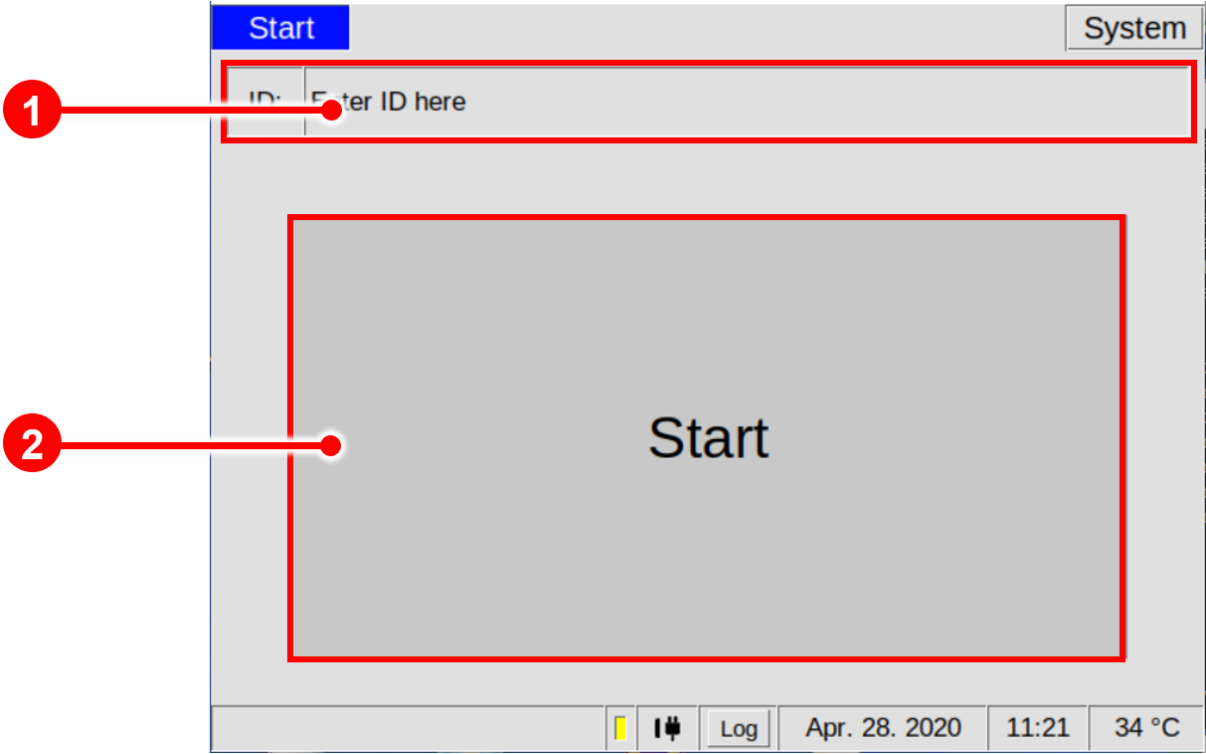

Figure 51: Operating Interface - Simplified View Window

1	ID	A measurement identification can be specified by the customer.
2	Start Button	By selecting this button the current program is started.

6.6.4 System Transfer Window

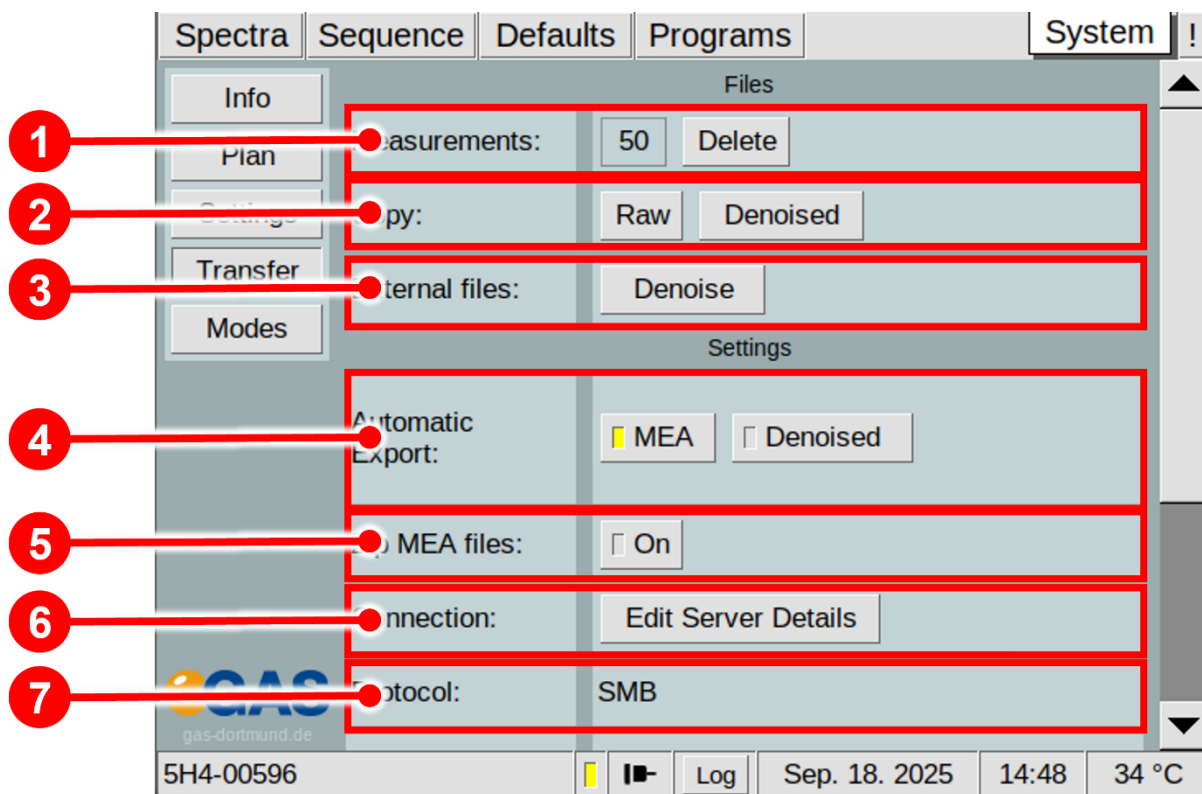

Figure 52: Operating Interface - System Transfer Window

<p>1</p>	<p>MEA Files:</p>	<p>The current number of internal stored measurement files and the following measurement file managing options are displayed and available:</p> <p>Copy: Copy the internal stored measurements to a connected USB device or to the connected shared folder.</p> <p>Delete: Select the internal stored measurement files for deleting.</p>
<p>2</p>	<p>Copy:</p>	<p>The current number of internal stored measurement files and the following measurement file managing options are displayed and available:</p> <p>Raw: Copy the internal stored measurements to a connected USB device or to the connected shared folder.</p> <p>Denoised: Copies a denoised version generated from the measured raw file to a connected USB device or to the connected shared folder.</p>

3	External files:	A raw file can be loaded into the system and subsequently denoised. This file can then be saved using the copy functions.
4	Automatic Export:	Automatic Export ensures that the generated measurement files are exported automatically. By activating this function, various formats can be specified: Mea : the raw files Denoised : the denoised files generated from the raw files
5	ZIP MEA Files:	Compresses the measurement data to zip.
6	Connection:	With Edit Server Details button the Export settings (transfer protocol, IPv4-address, shared folder name) can be set.
7	Protocol:	Displays the current used transfer protocol (smb , sftp or tftp).
8	User:	Displays the current used user name.
9	Server IP:	Displays the current used IPv4-address.

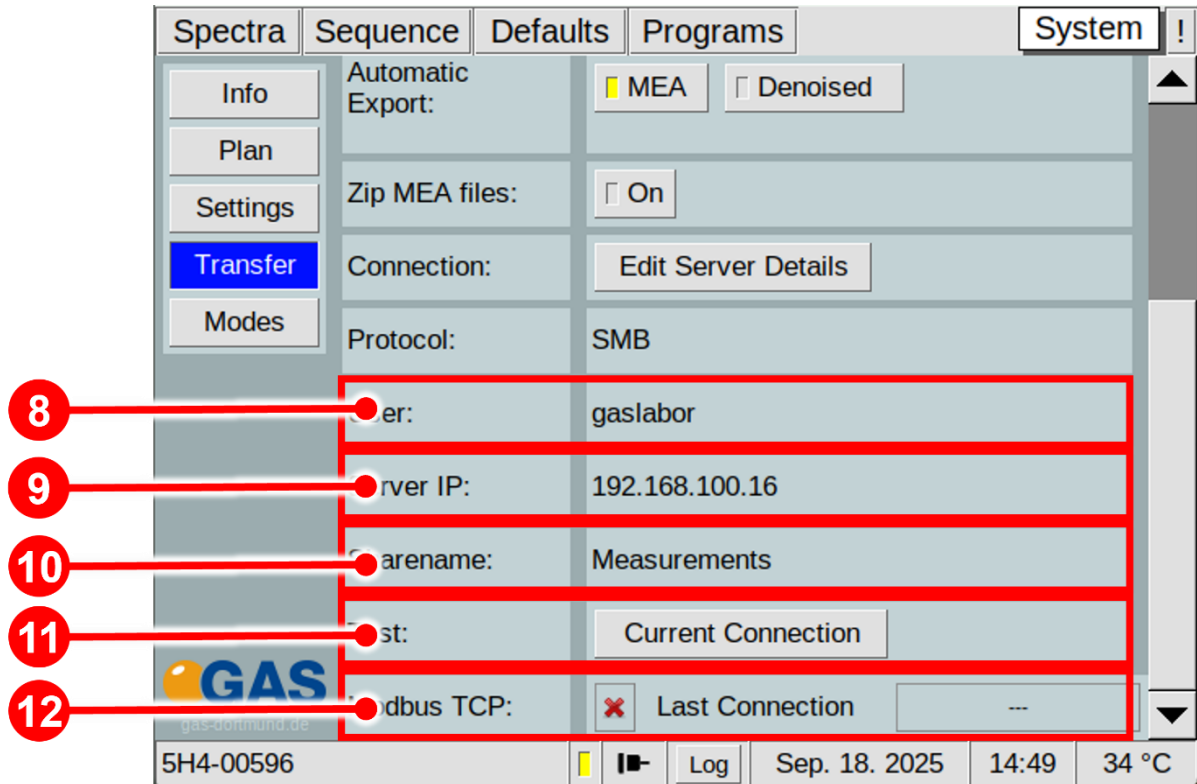

Figure 53: Operating Interface - System Transfer Window

8	User:	Displays the current used user name.
9	Server IP:	Displays the current used IPv4-address.
10	Sharename:	Displays the current used sharename of the storage folder.
11	Test:	With Current Connection button the device tries to establish to the shared folder using the current export settings. A message will appear to indicate if the connection was successful.
12	Modbus TCP	The last Modbus TCP connection can be checked. It will give you information on when and from which IP the last connection was made and whether it is still active.

6.6.5 Measurement files

Three types of measurement files can be generated.

Raw files: Raw files are the actual, untreated data that have been acquired. These are stored on the system's memory.

Raw files measured with positive drift voltage are saved in the format

YYYYMMdd_hhmmss.meas.

Raw files measured with negative drift voltage are saved with the extension NEG in the format **YYYYMMdd_hhmmss_NEG.meas.**

Denoised: These files are generated from the existing raw files and are only available temporarily. The signal-to-noise ratio is significantly improved by the applied mathematical algorithms. However, these are processed files.

Denoised files are saved with the extension DENOISED or NEG_DENOISED.

YYYYMMdd_hhmmss_DENOISED.meas. or

YYYYMMdd_hhmmss_NEG_DENOISED.meas.

6.6.6 System Modes Window

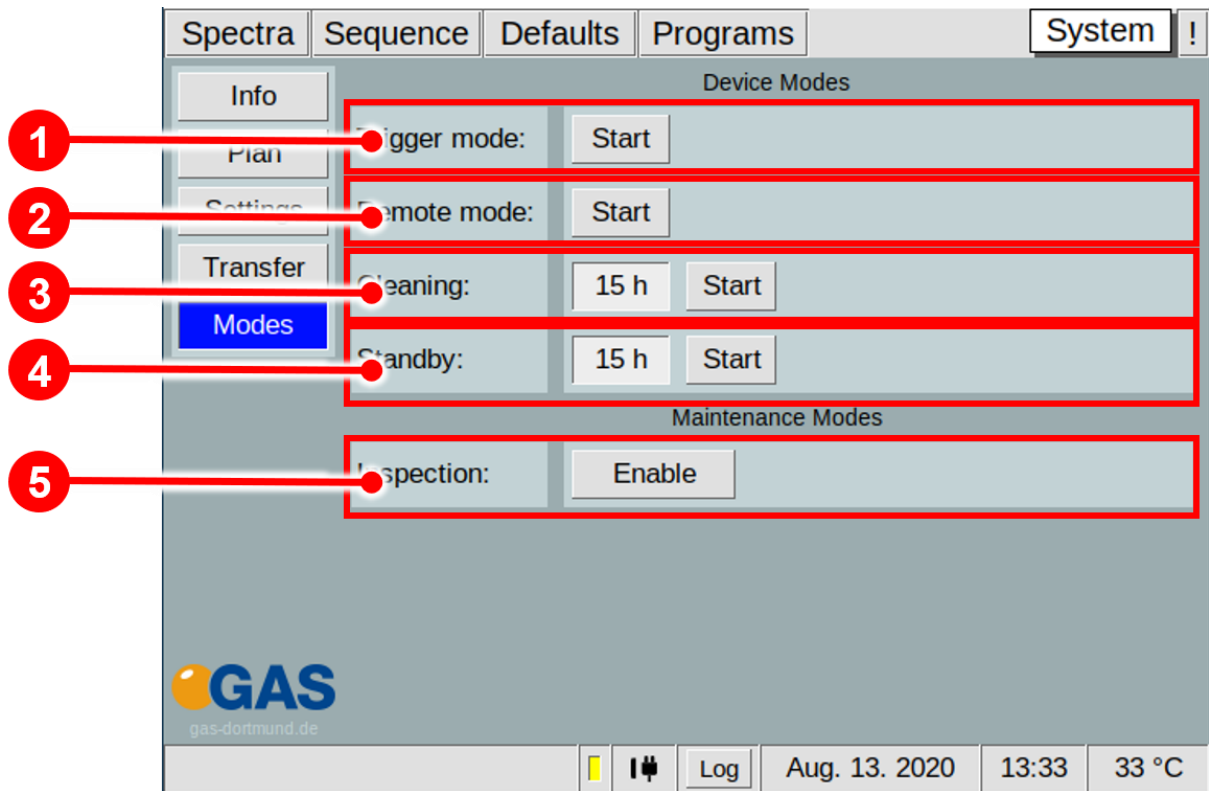

Figure 54: Operating Interface - System Modes Window

1	Trigger mode:	Activate trigger mode with Start .
2	Remote mode:	Activate remote mode with Start .
3	Cleaning:	Setup and activate of cleaning mode. With Start button the cleaning process is activated and the Cleaning Mode Window appears. Possible Values: (1-96 hours or infinity).
4	Standby:	Setup and activate of standby mode. With Start button the standby process is activated and the Standby Mode Window appears. Possible Values: (1-96 hours or infinity).
5	Inspection:	With Enable button the access to the inspection and diagnostic functions of the device is allowed.

6.6.6.1 Trigger Mode Window

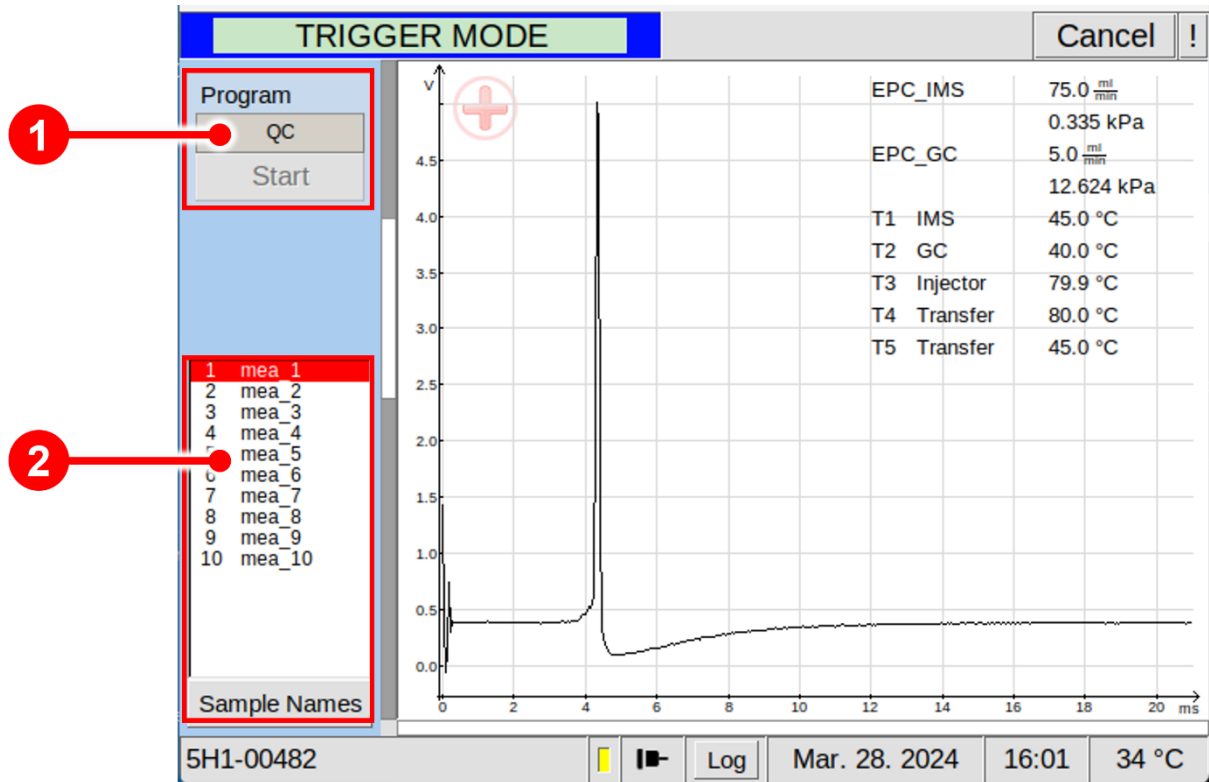

Figure 55: Operating Interface - Trigger Mode Window

1	Program Start Area	In Trigger mode the displayed program is started by a connected autosampler that operates as master device.
2	Sample Names Area	Displays the currently loaded sample names list. The current sample name is highlighted red. With this Sample Names button a sample names list file can be imported.

6.6.6.2 Remote Mode Window

By activating the Remote Mode, the **Remote Mode Window** appears. The windows is initially empty. The device is waiting for a sequence file to import.



INFORMATION!

The sequence file must be created with the **G.A.S. Sequence Designer Software**. For detailed Information refer to the **G.A.S. Sequence Designer Software Manual**.

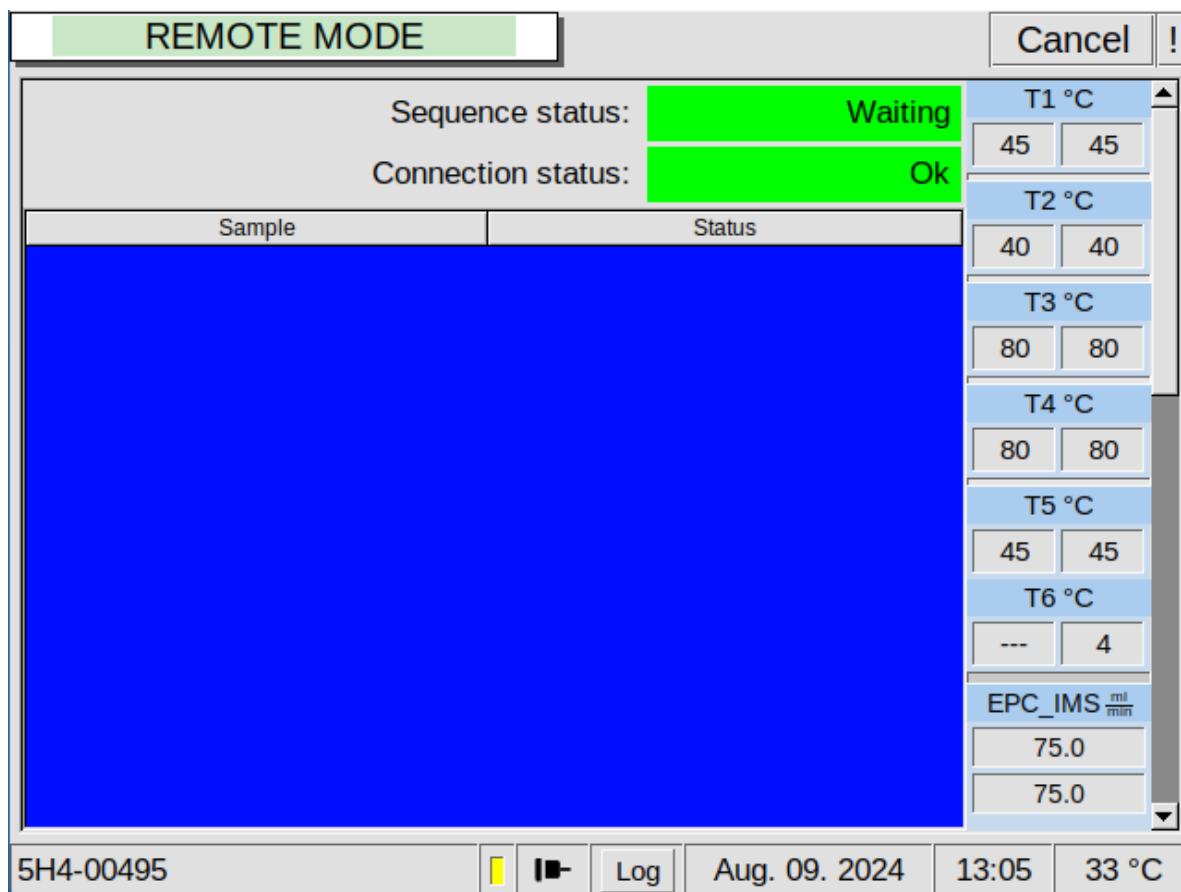

Figure 56: Operating Interface - Remote Mode Window

6.6.6.3 Cleaning Mode Window

By activating the Cleaning Mode, the **Cleaning Mode Window** appears. During the cleaning process the available system temperatures (T1-T6) are heated up to their maxima. The user default flow rates settings for drift gas (EPC_IMS) and carrier gas (EPC_GC) setup in defaults window are used. After the setup time has expired the cleaning process is terminated.

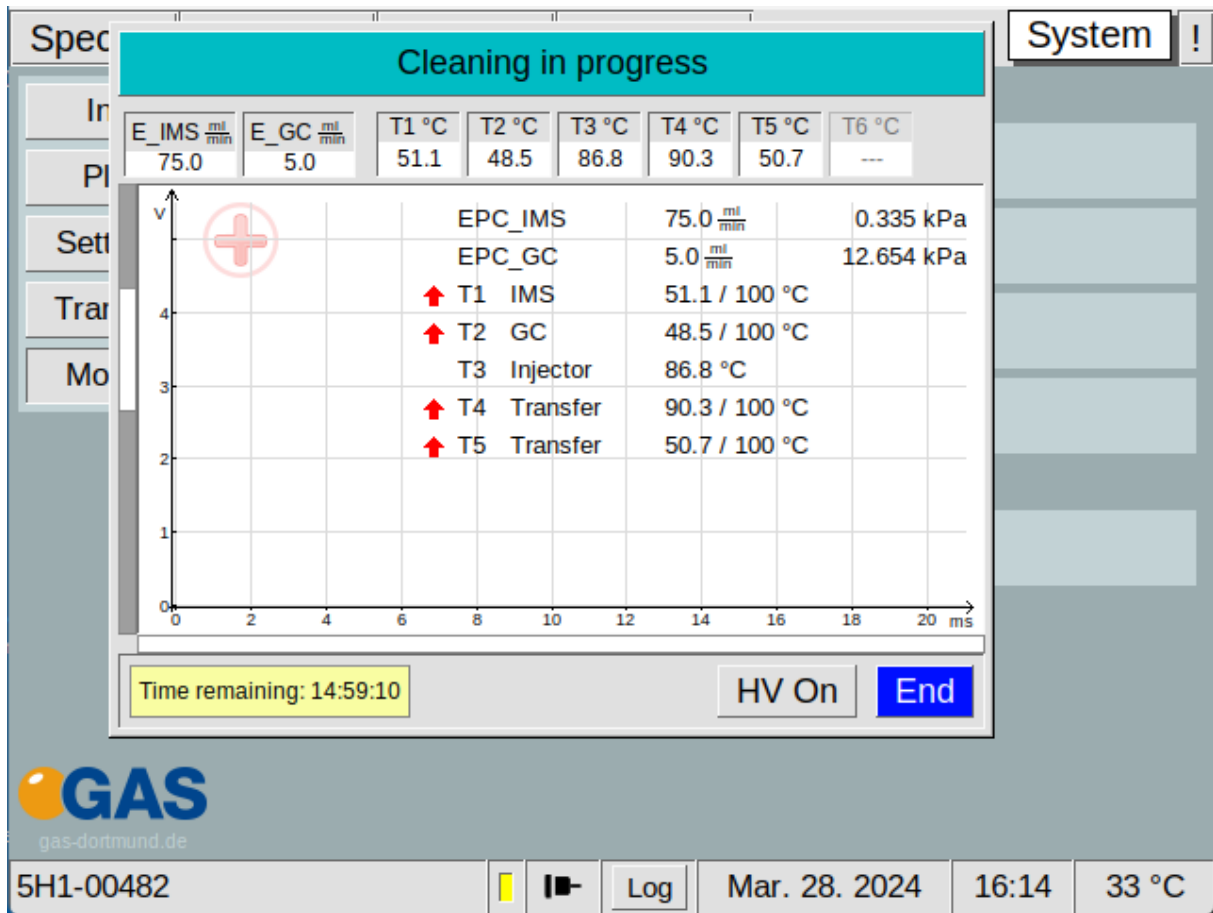
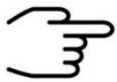

Figure 57: Operating Interface - Cleaning Mode Window



INFORMATION!

During the cleaning process the available heating module temperature (T1-T6) are set to their maxima. The drift voltage is switched off. The drift voltage can be switched on temporarily via the **HV On** button to view the spectra.

6.6.6.4 Standby Mode Window

By activating the Standby Mode, the **Standby Mode Window** appears. The flowrate of the drift gas (EPC_IMS) and the carrier gas (EPC_GC) will be decreased to reduce gas consumption. The **standby mode flowrate** for drift gas (EPC_IMS) is **10 ml/min** and for carrier gas (EPC_GC) is **5 ml/min**.

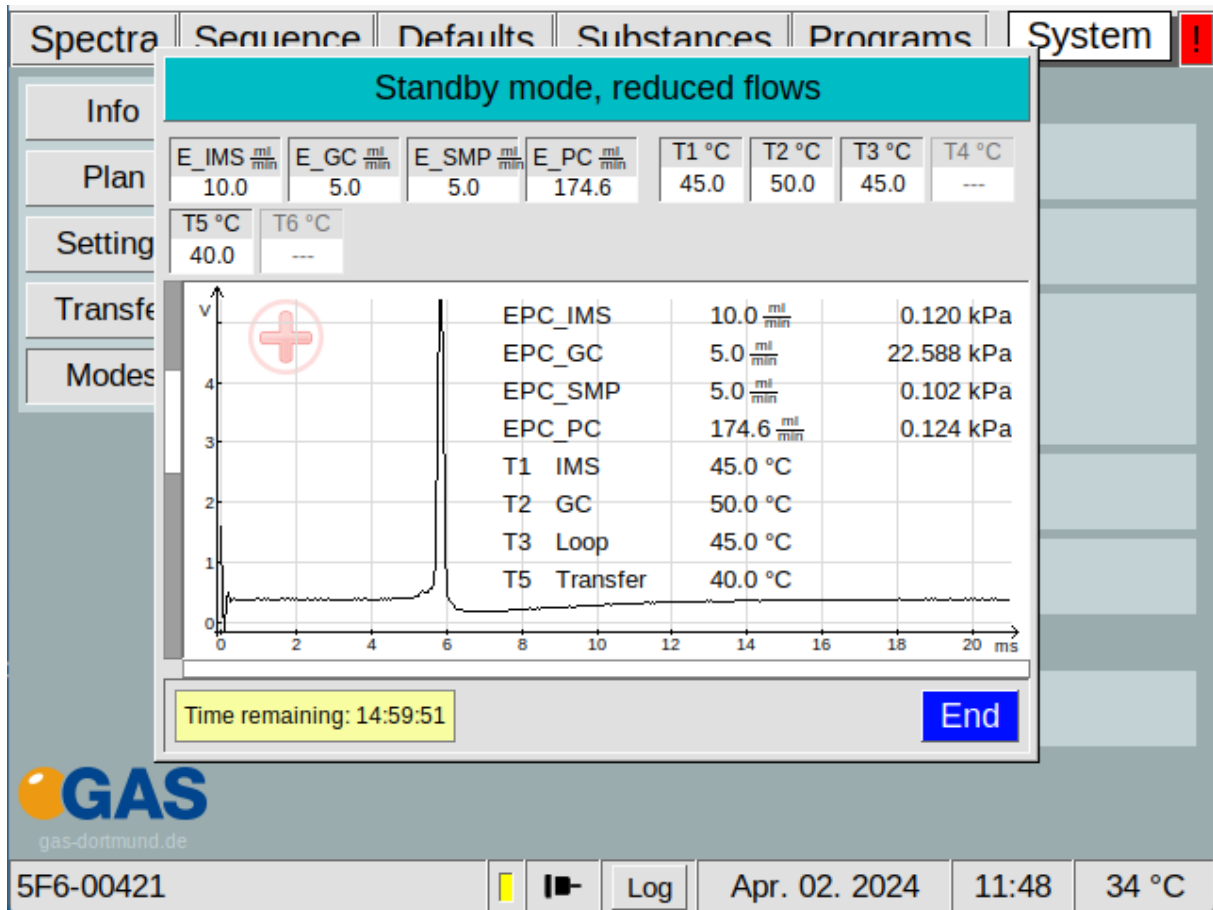

Figure 58: Operating Interface - Standby Mode Window

6.7 Error Information Window

In case if an Error the **I-Tab** is blinking red. The error window shows an overview of the current error events. When the device is restarted, the error events are deleted.

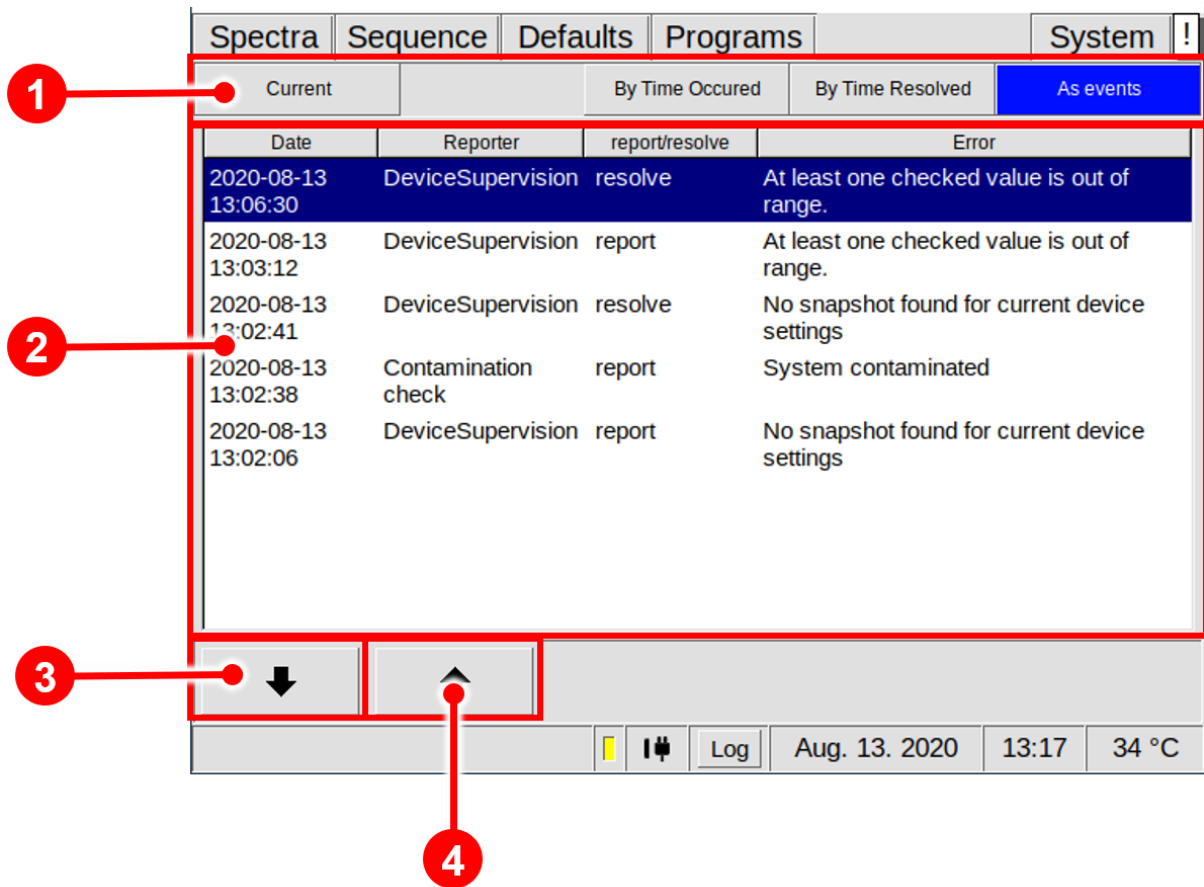

Figure 59: Error Information Window

1	Selection Sort Order Bar	Selects the following sort order: Current ; By Time Occurred ; By Time Resolved ; As Event
2	Entry List	A list of system event messages. The display depends on the selected sort order.
3	Down Button	Scrolls one message down.
4	Up Button	Scrolls one message up.

6.8 Additional Dialog Windows

6.8.1 Log Messages Dialog Window

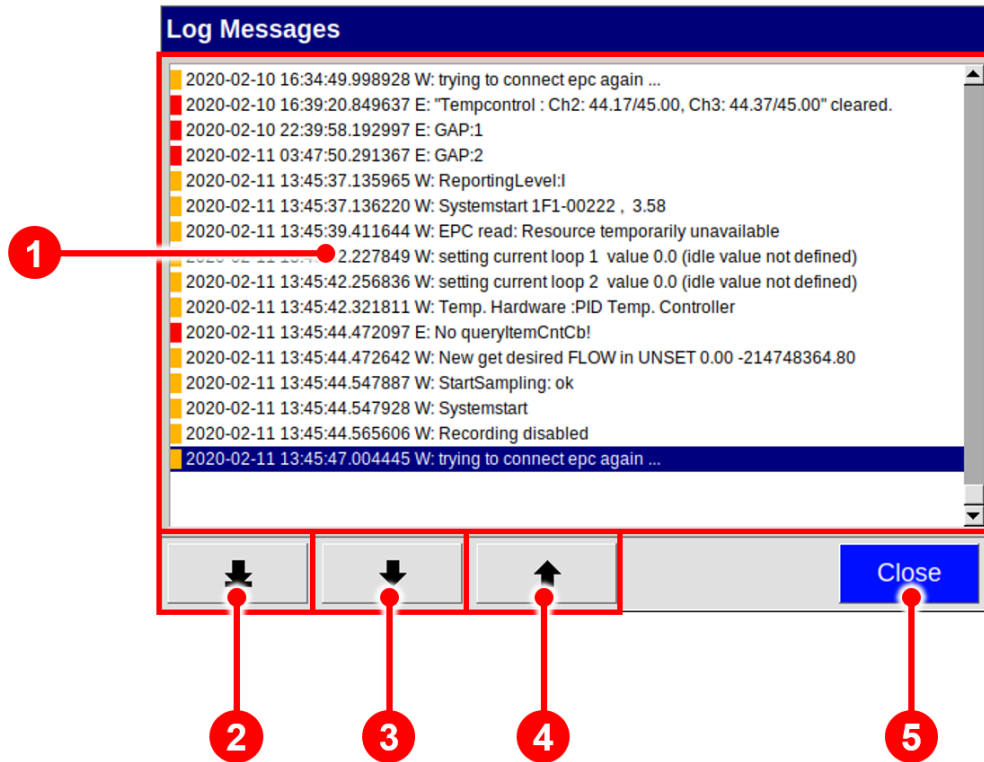

Figure 60: Log Messages Dialog Window

1	Entry List	A chronological list of system event messages. Warnings are marked orange, error messages are marked red.
2	To Last Entry Button	Scrolls down to the latest entry.
3	Page Down Button	Scrolls one page down.
4	Page Up Button	Scrolls one page up.
5	Close Button	Closes the dialog.

6.8.2 IP Adress Input Dialog Windows

The IP Address Input Dialog is used to edit the static IP address of the device and the IP address of a remote server. This is necessary when configuring the LAN file transfer.

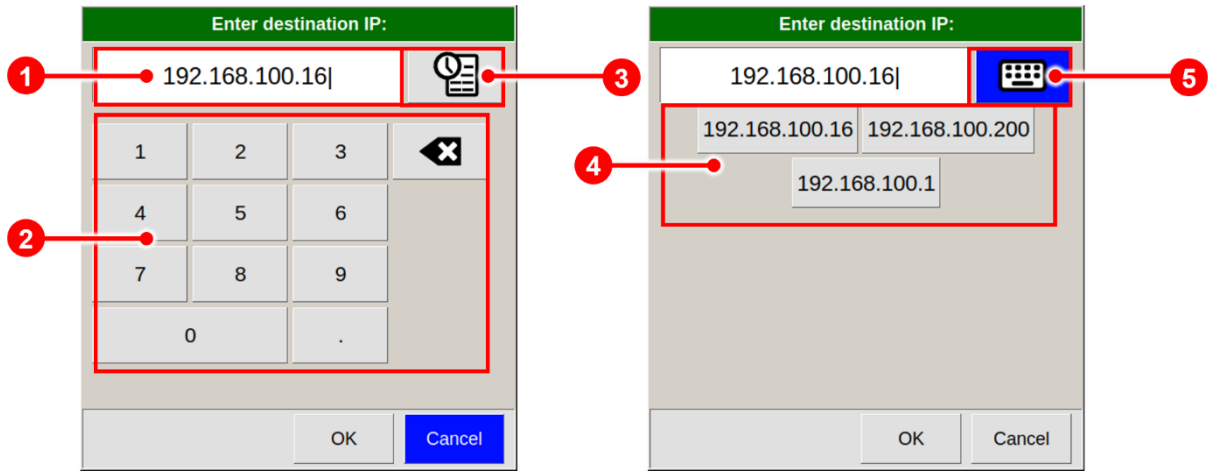

Figure 61: IP Adress Input Dialog Windows

1	IP Address Field	The current IP address.
2	Digit and Dot Buttons / Backspace Button	Use these buttons to enter an IP address.
3	History Button	Displays a menu of previously used IP addresses to choose from.
4	History Entry Button	Button for selecting previously used IP addresses.
5	Keyboard Button	Displays the keyboard.

6.8.3 Date and Time Input Dialog Window

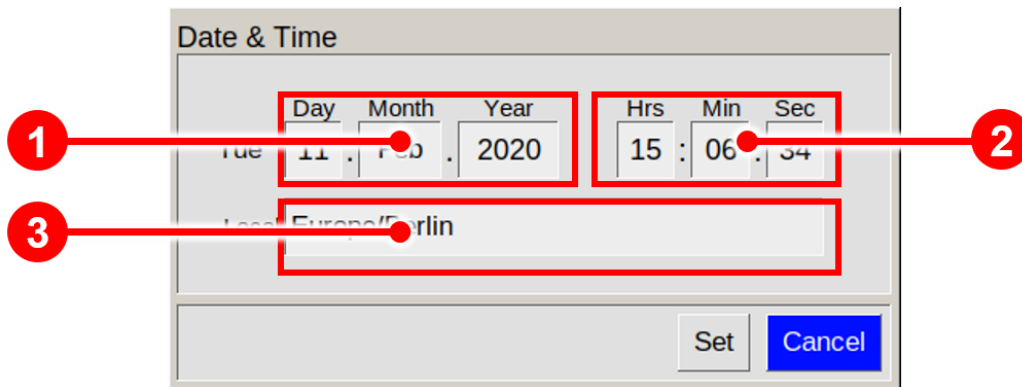

Figure 62: Date and Time Input Dialog Window

1	Date Fields	Fields displaying and modifying day, month and year.
2	Time Fields	Fields displaying and modifying hours, minutes and seconds.
3	Timezone	Field for selection of timezone.

6.8.4 Text Input Dialog Window

The Text Input Dialog is used to enter identifiers, e.g. shared folder name.

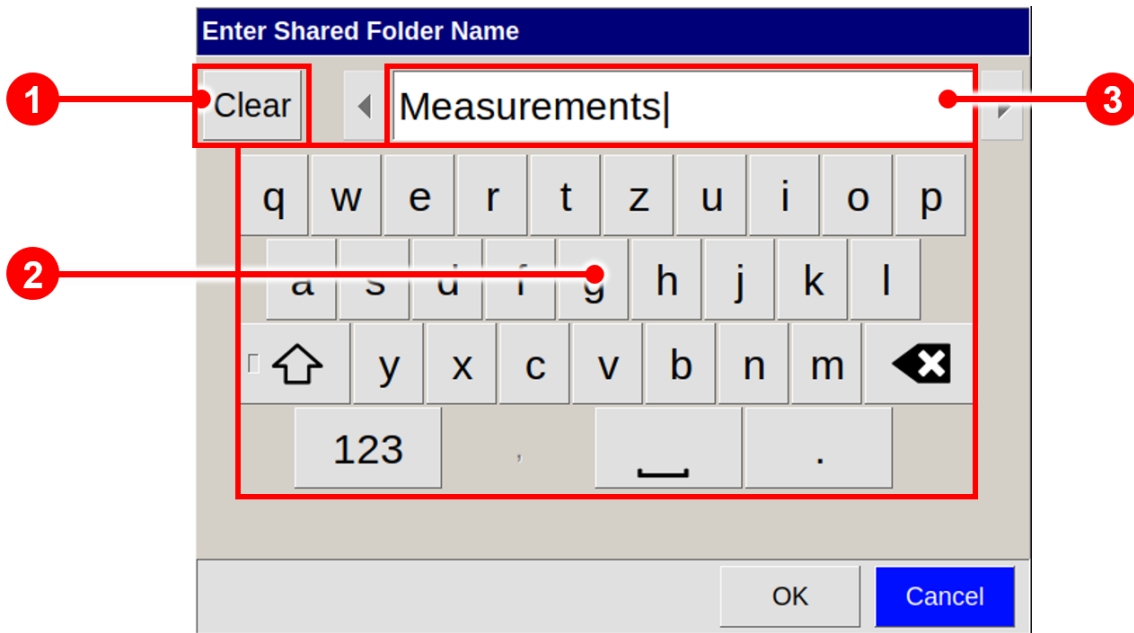

Figure 63: Text Input Dialog Window

1	Clear Button	Deletes the text in the current text field.
2	Keyboard Buttons	Character and control buttons for entering a text. Depending on the context some buttons are disabled.
3	Current Text Field	The editable text.

6.8.5 Number Input Dialog Window

The Number Input Dialog is used in Program Window to enter number values, e.g. start time, recording and flow rate setpoints in program actions.

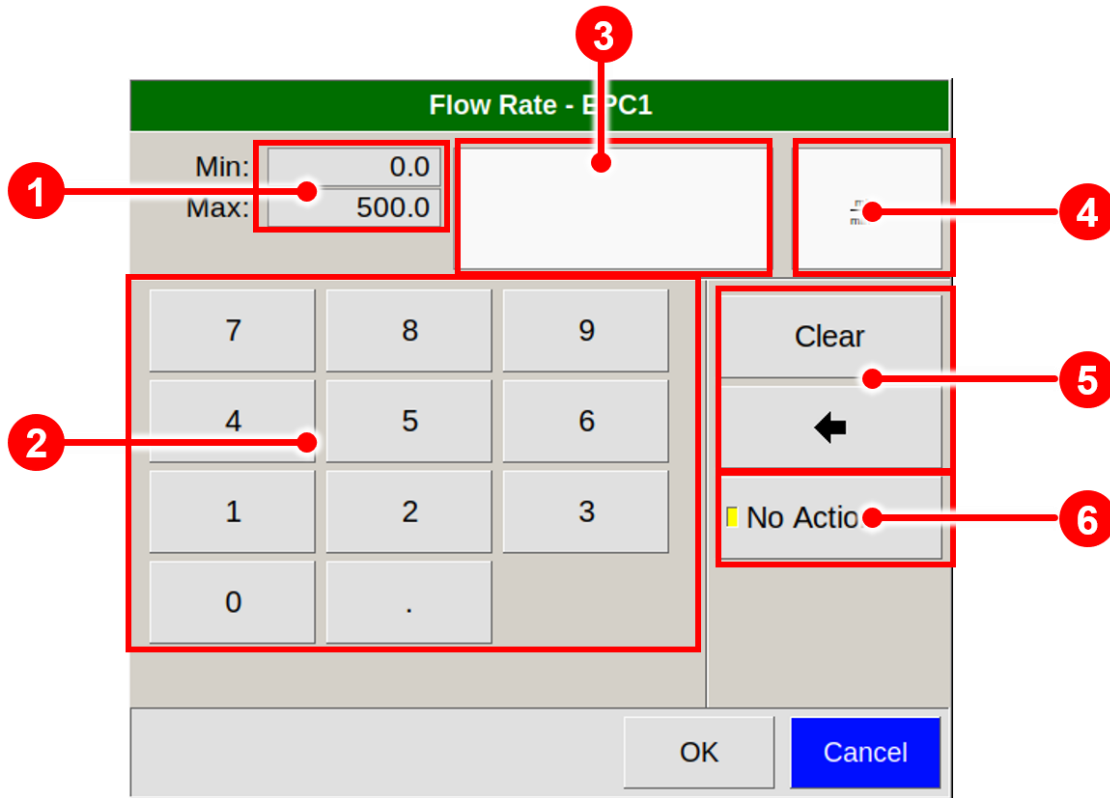

Figure 64: Number Input Dialog Window (Example)

1	Range / Raster Info	Displays the valid value range.
2	Keyboard Buttons	Buttons for entering a number.
3	Value Field	The entered numerical or selected special value.
4	Unit	Value unit name.
5	Clear and Backspace Button	Buttons for clearing the input field or deleting the last digit.
6	Dedicated Values Button	Dedicated value like No Action (only if available).

6.9 PAL3 RSI Autosampler-Terminal

The PAL3 RSI Autosampler can be controlled by using a terminal. It is the main input unit for user interaction.

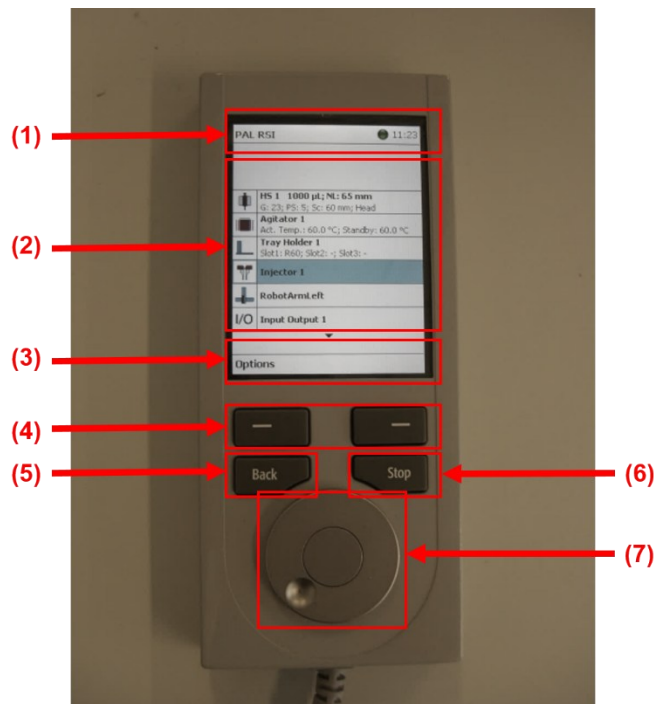

Figure 65: Autosampler Terminal

1	Status Bar	Selected section, the status and time are displayed.
2	Content Area	Shows the list of selected items.
3	Menu Bar with function keys	Shows the options for the function keys.
4	Menu Buttons	With the function keys the actual option in the menu bar can be selected.
5	Back Button	Press the Back button to return to the previous page. If the Back button is pressed continuously the cursor will jump back to the home screen.
6	Stop Button	Pressing the Stop button will abort the ongoing activity.



Pushable Rotary Knob

Rotate the outer wheel to move the cursor bars.
Press the inner knob to select an item or ENTER a selection.

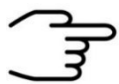

INFORMATION!
For detailed Information refer the PAL3 RSI Operating Manual.

6.10 Remote control of the PAL3 RSI with the PAL Control software

The PAL3 RSI can be controlled using the PAL Control remote control software. The methods and jobs can be controlled.

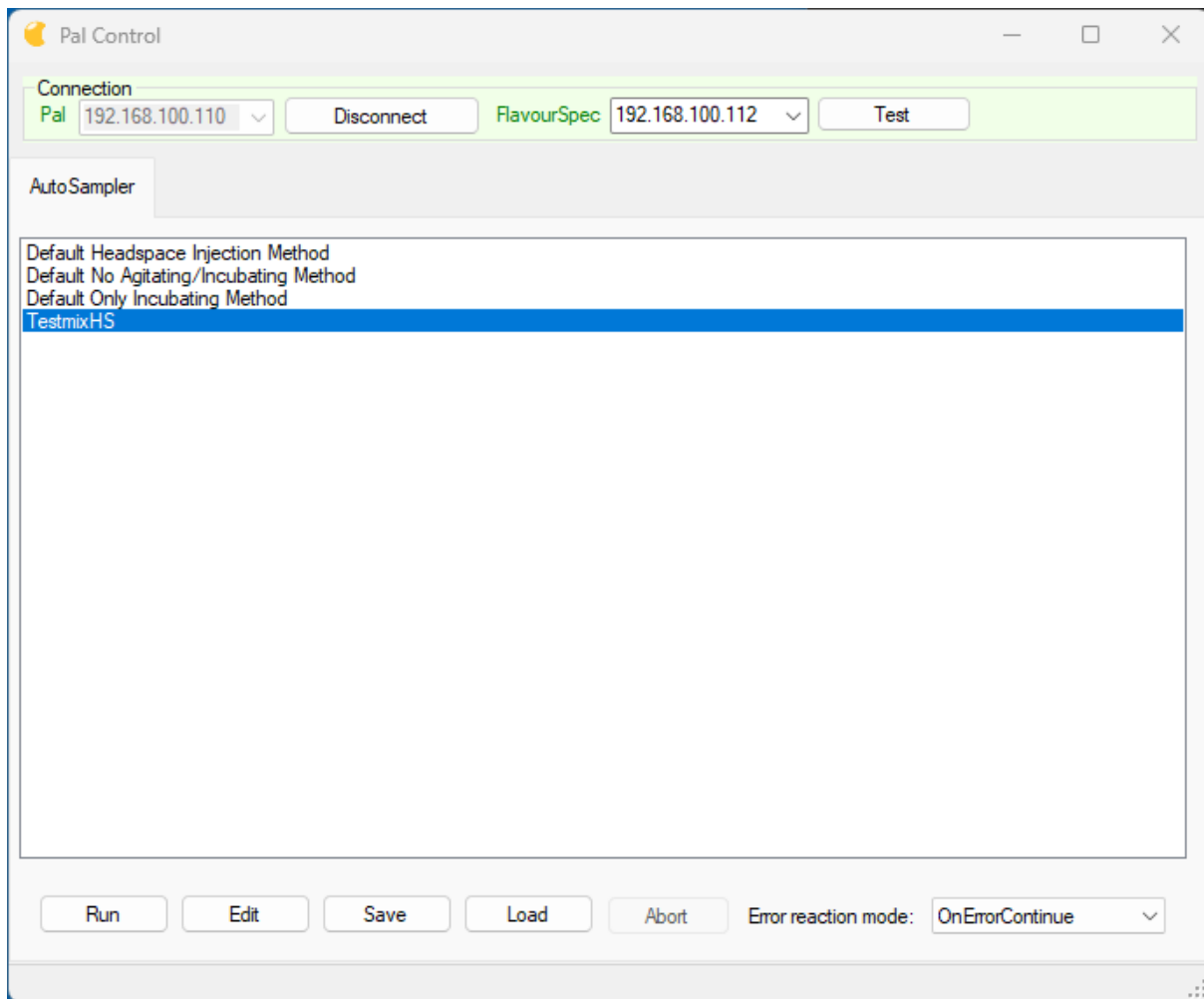

Figure 66: PAL Control Software



INFORMATION!
For detailed Information refer the PAL Control Manual.

7 Installation

7.1 Installation Requirements

The following requirements must be fulfilled by the customer:

Location of Installation

- Available space of 1000 x 900 x 800 mm (W x D x H)
- Ambient temperature of 5 – 40°C
- Humidity: 0-90% RH, non-condensing
- Robust table with a minimum carrying capacity of >40 kg

Power Supply

- Electricity supply free of interferences
- Power Supply of 230 V \pm 10%, 50 - 60 Hz \pm 1%

Gas supply

- Nitrogen (Quality 5.0 (99.999%) or Synthetic Air (Quality 5.0 (99.999%))
- Stainless steel pressure reducer with 3 mm or 1/8" Swagelok-Connector adjustable pressure range of 3 – 6 bar and 3 mm Swagelok connector

Safety

- Availability of exhaust system for device exhaust gas tubes (Gas Out and Sample Out)

Computer

- Computer with current Microsoft Windows operating system
- Administrator right to install G.A.S. software

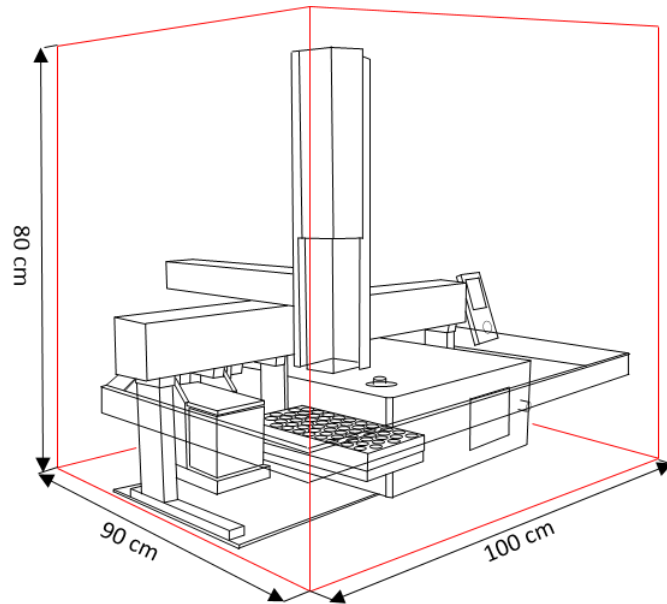

Figure 67: Space requirement FlavourSpec® with Autosampler PAL RSI



INFORMATION!

To ensure correct measurements it is absolutely necessary to **connect the supplied exhaust tubes** (Gas Out and Sample Out).

The exhaust tubes (Gas Out and Sample Out) **must be led separately into the exhaust system and must not be connected.**

The exhaust system must **not generate any negative pressure.**

7.2 Unpack the device



At least two people are necessary to unpack the device.

1



Remove the cover.

2



Remove the accessory box.

3



Remove the cardboard spacer..

4

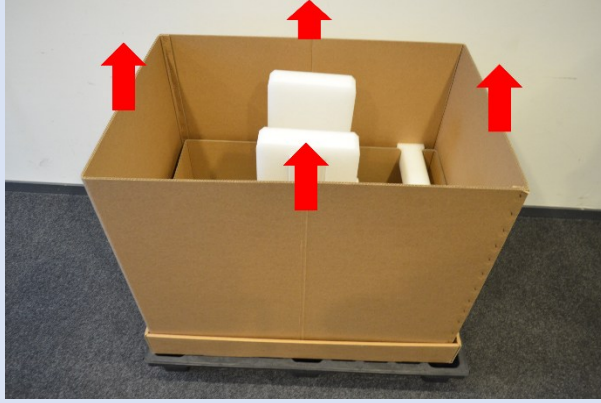

Remove the outer transport cover

5



Remove the right foam spacer.

6

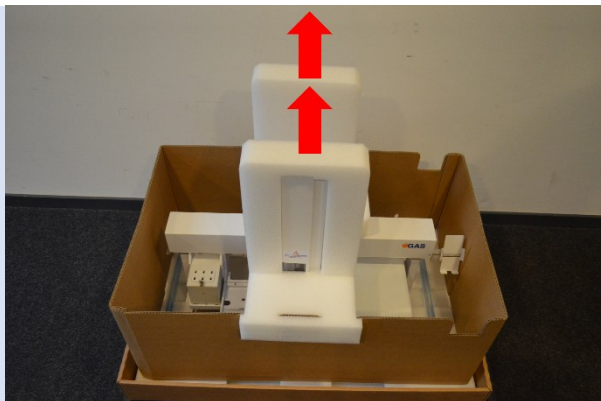

Remove both foam spacers.

7

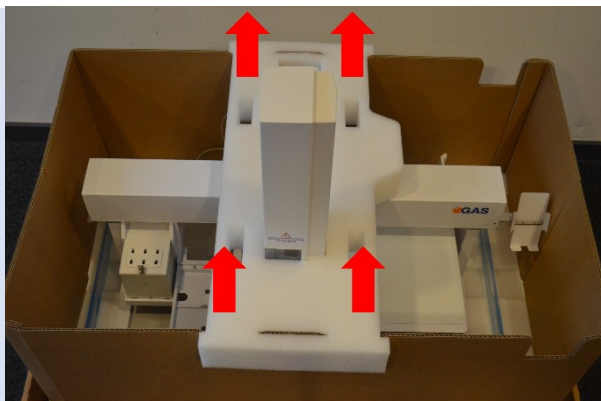

Remove the middle foam spacer.

8

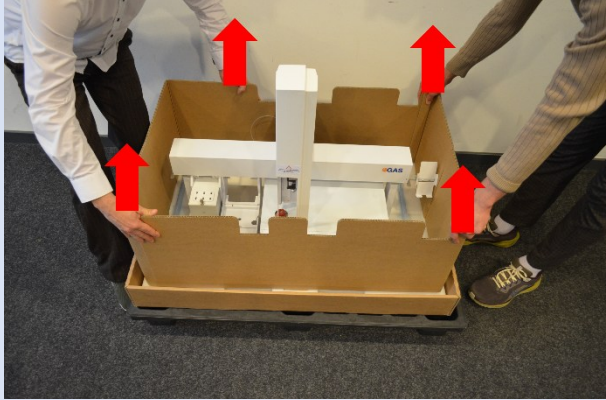

Remove the inner transport cover

9

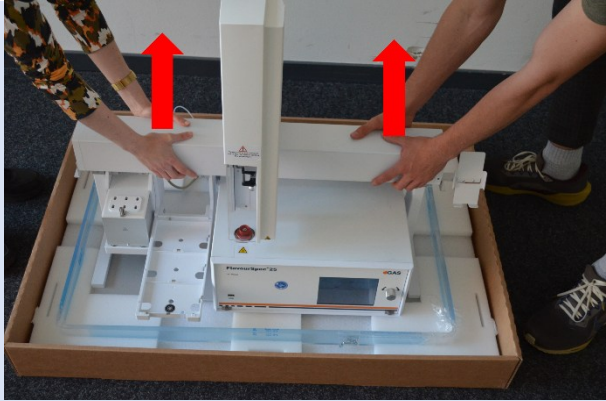

Lift the device carefully.



WARNING!
The arm of the autosampler can move freely. It is recommended to hold the arm by a third person.

10

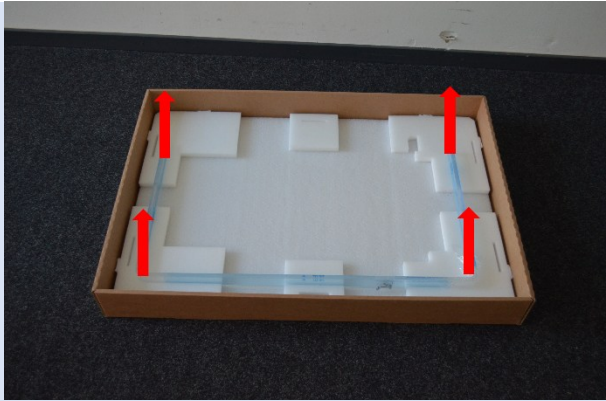

Take the safety guard out.

11

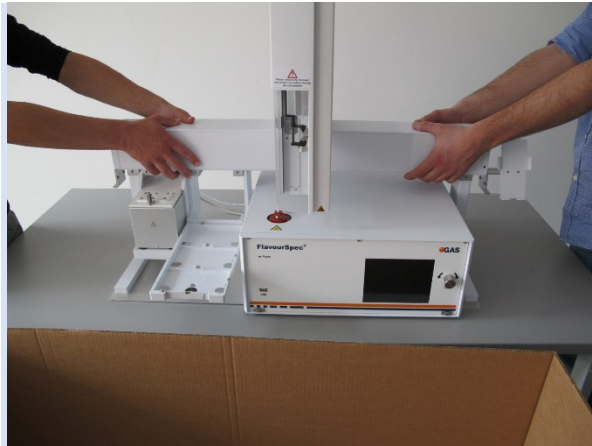

Put the device on a stable table.

12

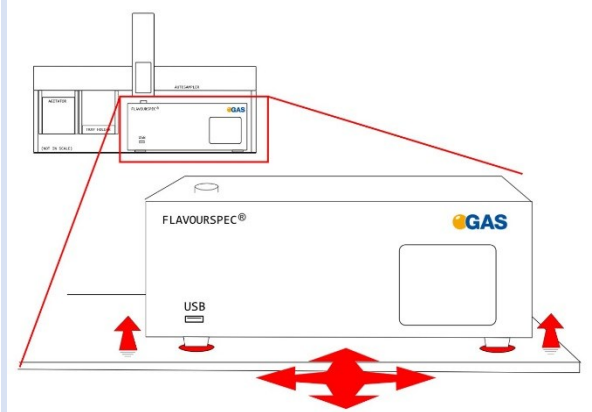

Check the position of the instrument feet.

The instrument feet and the position holes of the baseplate must fit.

7.3 Unpack the accessories

1



- 1** Accessory box
- 2** Packing list

2



The figure shows the opened box.

3



The figure shows the delivered standard components.

Check the entire delivery for completeness on basis of the packing list.

4

- 1 FlavourSpec® documents (printed out and in digital form on the USB-memory stick)
- 2 Custom ketone mix
- 3 Autosampler owner documents CTC
- 4 FlavourSpec® torx screwdrivers
- 5 PAL RSI torx screwdrivers
- 6 Molecular sieve and two holders
- 7 20 mL headspace vials
- 8 Magnetic caps for headspace vials
- 9 Crimper
- 10 PAL RSI teaching tool
- 11 Agitator replacement belts
- 12 Terminal
- 13 FlavourSpec® power supply
- 14 PAL RSI power supply
- 15 PAL RSI Syringe Kit
- 16 FlavourSpec® LAN cable
- 17 PAL RSI LAN cable
- 18 Septa
- 19 PAL RSI wrenches
- 20 FlavourSpec® Gas Tube Kit
- 21 Tray
- 22 FlavourSpec® and PAL RSI power cable

7.4 Mount the Safety guard

1



The necessary screws are included.

2

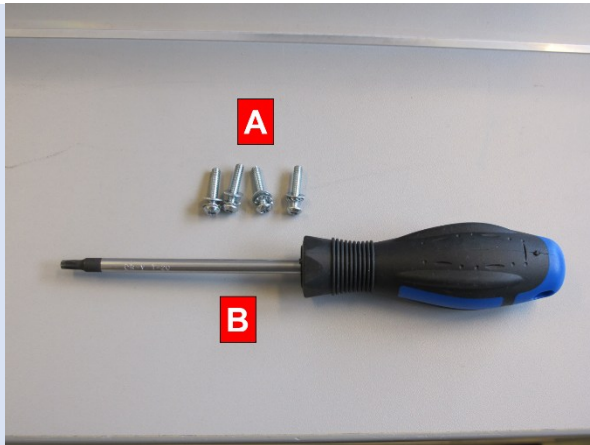

To connect the Safety Guard the following required:

A: 4x M4 Torx screws with spring washer and washer

B: Screwdriver Torx T20

3

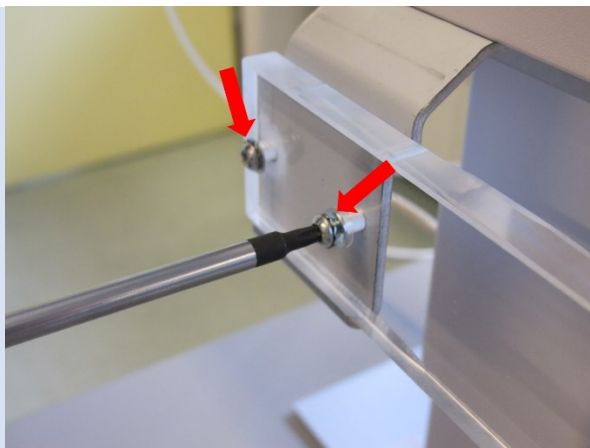

Connect the Safety Guard to the Safety Guard Brackets on the left and ...

4

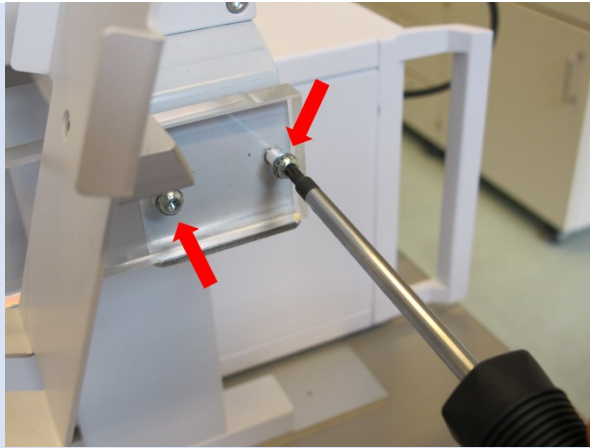

...and on the right side of the X-Axis using the screws.

5



The figure shows the autosampler with installed Safety Guard.

7.5 Connect the PAL3 RSI Terminal

1



Connect the Terminal cable to the Terminal connector (green marking).

2



Place the Terminal into the Terminal Holder.

7.6 Check the Preinstalled Connection Cable

1

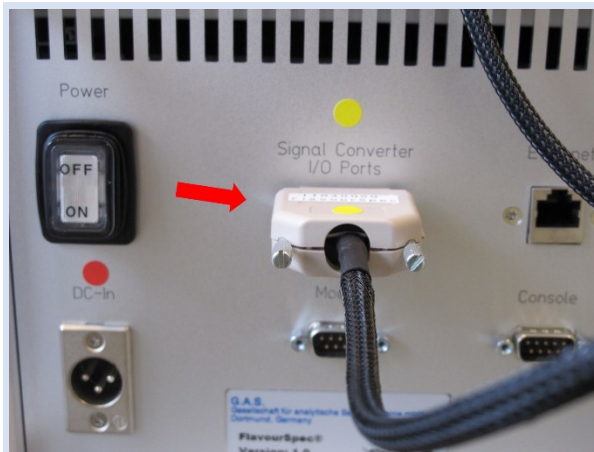

Rear FlavourSpec®:
Check the connection cable Autosampler/ FlavourSpec® (grey Plug, yellow marking) at the Signal Converter I/O Ports.

2

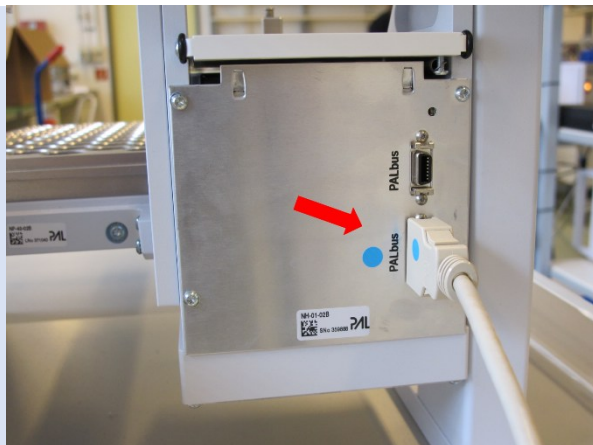

Rear Agitator:
Check the connection cable Agitator (blue marking) at the port PALbus.

3

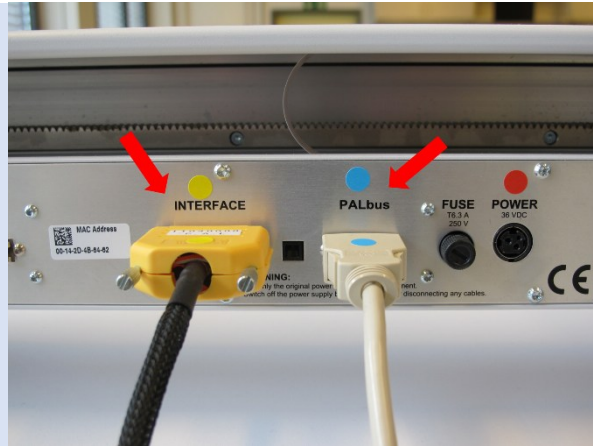

Rear RSI Autosampler X-Axis:

Check the connection cable Agitator (blue marking) at the port PALbus.

Check the connection cable Autosampler/ FlavourSpec® (yellow plug, yellow marking) at port Interface.

4

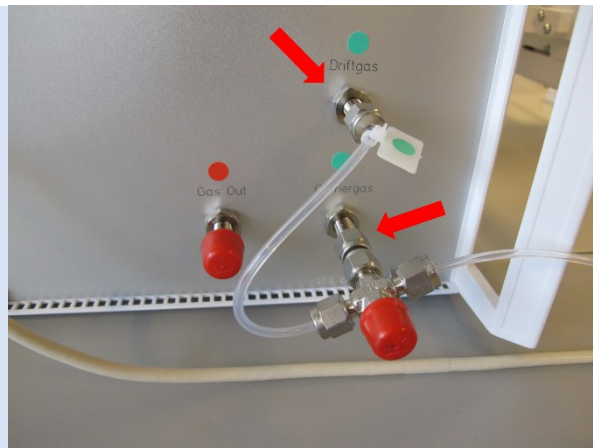

Rear FlavourSpec®:

Check the 3 mm Swagelok-Connection of the drift gas-/carrier gas-adapter.

7.7 Connect the Gas Supply

1

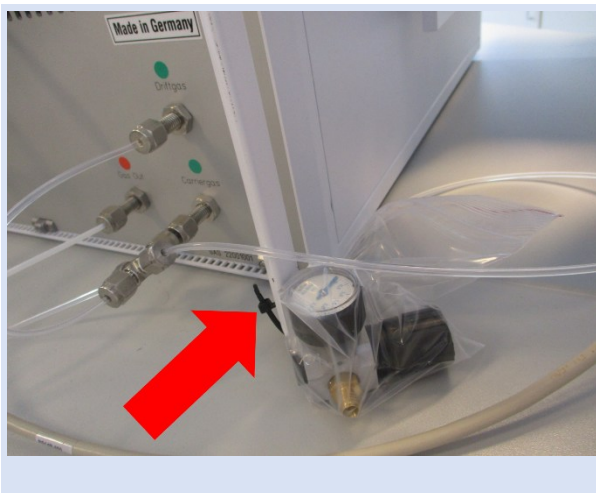

Release the pressure reducer.

2

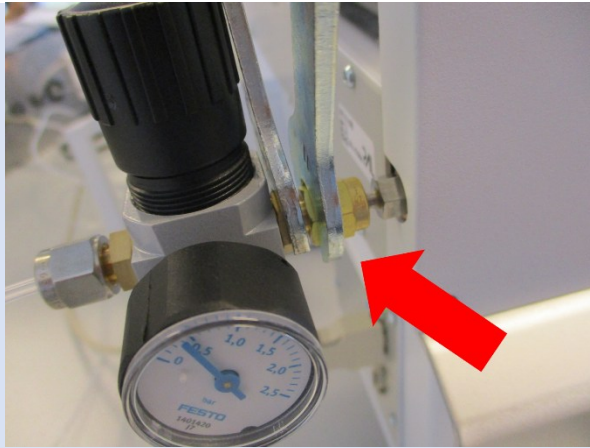

Mount the pressure reducer at the rear of the autosampler.

3

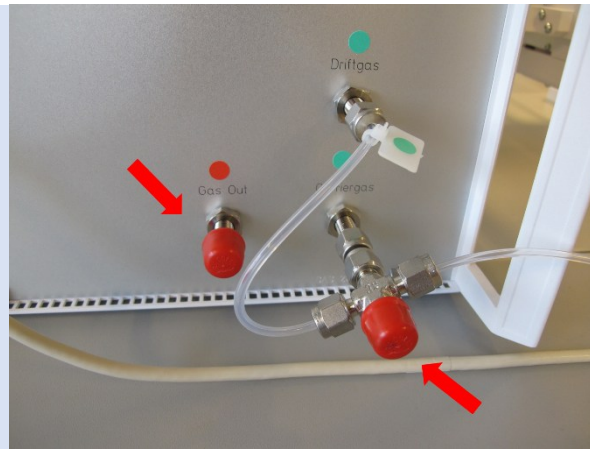

Remove the red caps on the rear panel of the device. **Keep the red caps.** These are the gas seals.

4

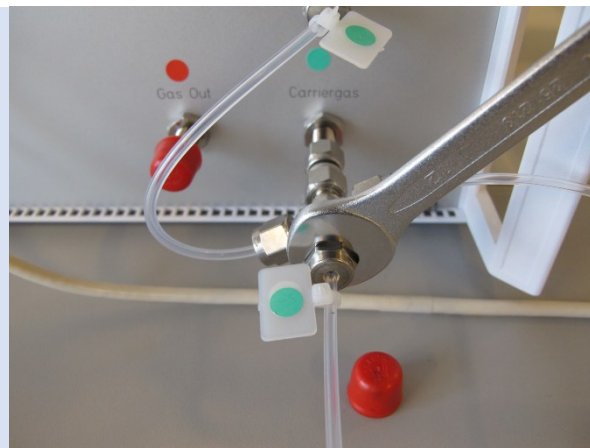

Connect the tubing (green marking) with 3 mm Swagelok-connection to the drift gas/carrier gas-connection using a 12 mm wrench.

5

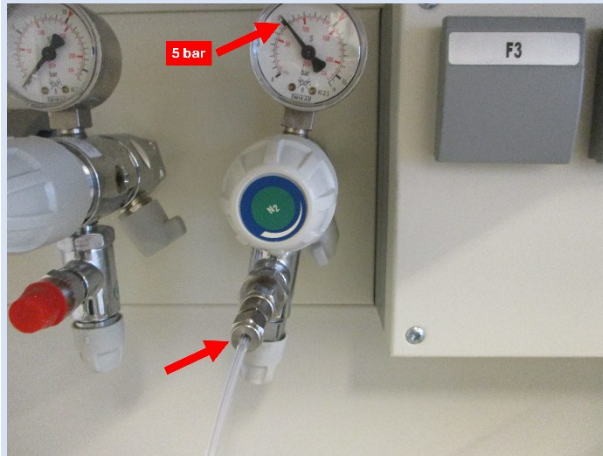

Connect the tubing to a nitrogen or synthetic air gas supply. (gas quality: nitrogen 5.0 or synthetic air 5.0).

Set up the back pressure to 3-6 bar
Recommended 5 bar!

6

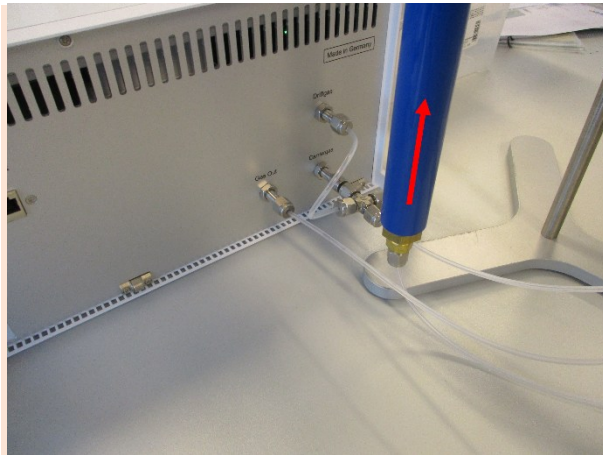

OPTIONAL

To ensure a high purity of the gas install the delivered molecular sieve in vertical position.

The picture shows an example of a molecular sieve.

7

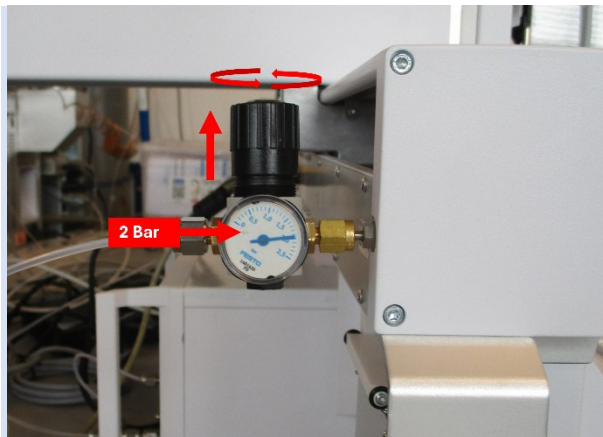

Pull the regulator up to unlock it.

Set the purge gas pressure to **2 bar**.

Then push it back down to lock it.

8

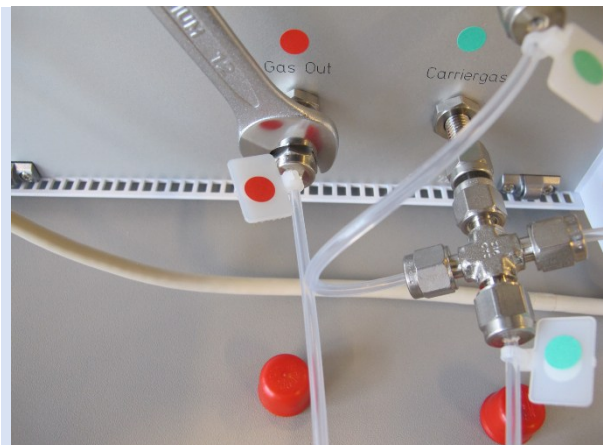

Connect the waste tube (red marking) with 3 mm Swagelok-connection to the Gas Out connection using a 12 mm wrench.

Connect the other end of the tube to an adequate laboratory waste system.



INFORMATION!

Only use stainless steel pressure reducer, PFA tubes with 3 mm outer diameter and 3 mm Swagelok connectors.

To ensure a high purity of the gas install the provided moisture trap.

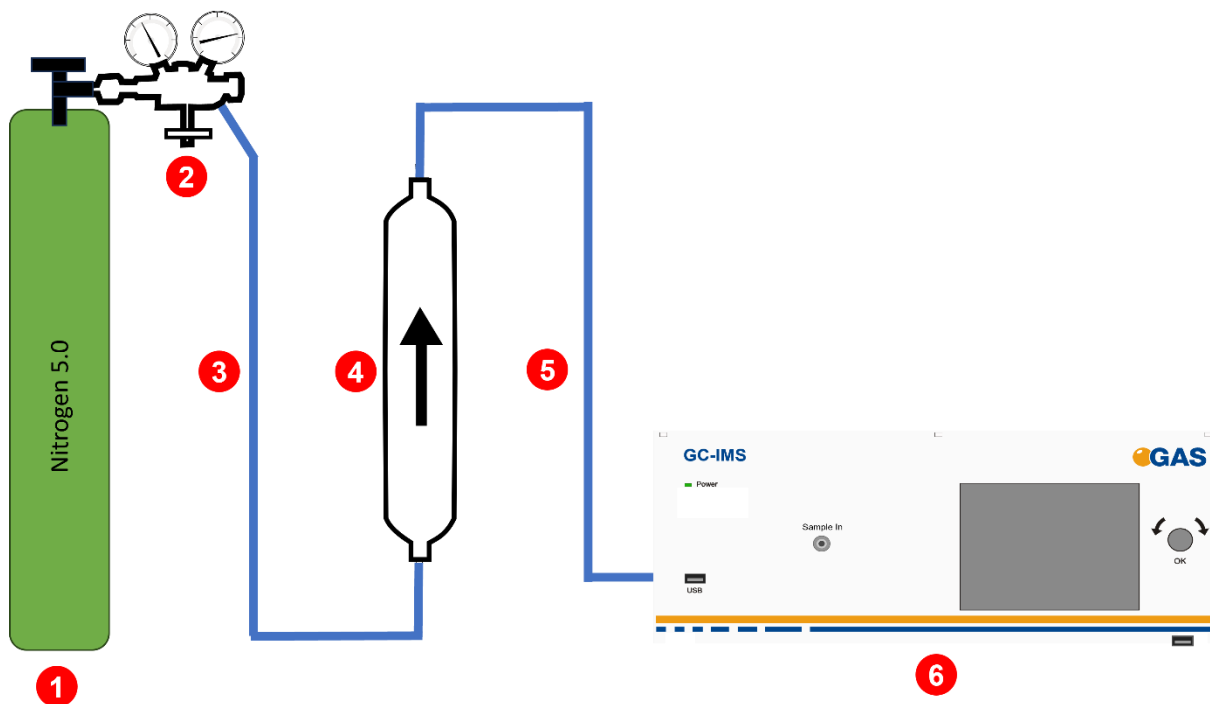
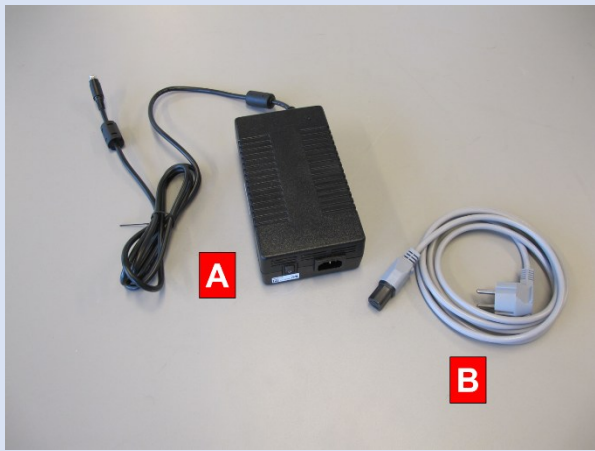
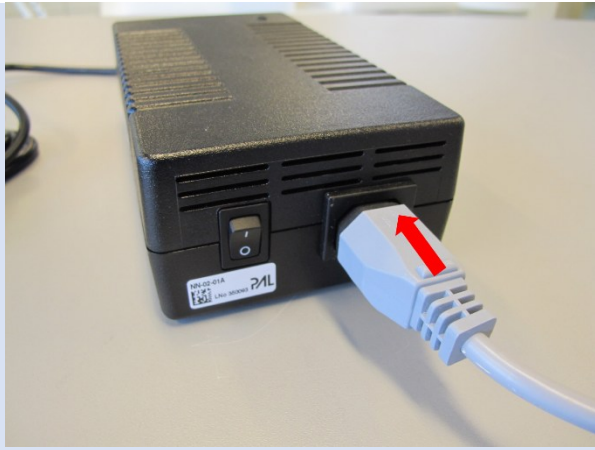

Figure 68: Gas supply installation (schematic)

1	Gas supply e.g. gas bottle with Nitrogen 5.0 (provided by customer)
2	Pressure reducer (provided by customer)
3	2 m PFA gas tube with 3 mm Swagelok connector (provided by G.A.S.)
4	Molecular sieve with 3 mm connection (provided by G.A.S.)

- 5** 2 m PFA gas tube with 3 mm Swagelok connector (*provided by G.A.S.*)
- 6** Device (*provided by G.A.S.*)

7.8 Connect the Power Supply

1		<p>Power Supply Autosampler: A: PAL RSI Autosampler Power Supply B: Country-specific Power Plug</p>
2		<p>Connect the power supply unit with the power plug.</p>

3



Connect the power supply to the power connector at the rear of the PAL3 RSI Autosampler (red marking).

4

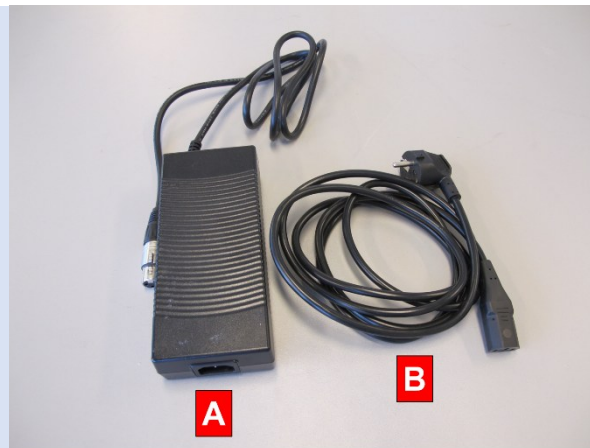

Power Supply
FlavourSpec®:
A: FlavourSpec® Power Supply
B: Country-specific Power Plug

5



Connect the power supply unit with the power plug.

6



Connect the power plug to the power connector at the rear of the FlavourSpec® (red marking).

7.9 Remove the Transport lock

1



Transport lock sign at the front of the autosampler.

2

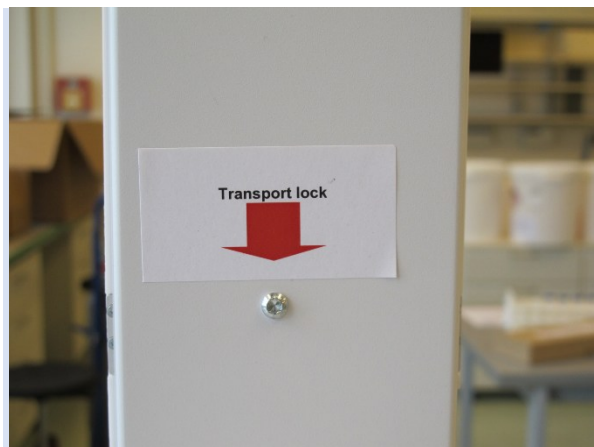

Transport lock sign at the rear of the autosampler.

3



Remove the transport lock screw with a screwdriver (Torx T20).

Keep the screw for future use.

7.10 Complete the Device

1



Place the tray to the tray holder.

7.11 Switch on the Device

1



Switch on PAL RSI Autosampler.

2



Switch on the FlavourSpec®.



INFORMATION!

For detailed information concerning the autosampler please refer the autosampler manual.

7.12 Check essential device position

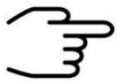

Before working with the instrument the position of the injector, agitator and the trayholder must be tested and if necessary adapted.

1

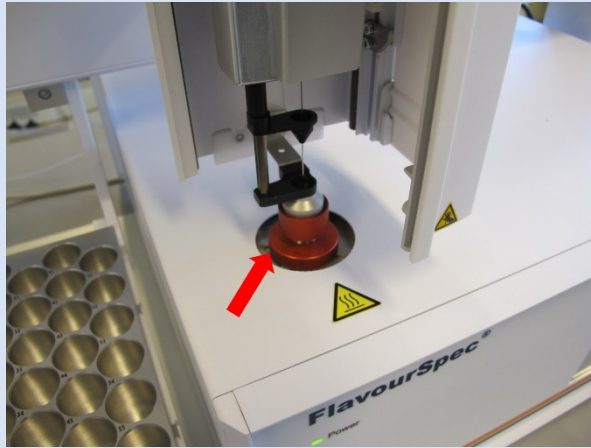

Check the position of the injector (see chapter 8.5).

OPTIONAL

Teach the position of the injector (see chapter 8.9)

2

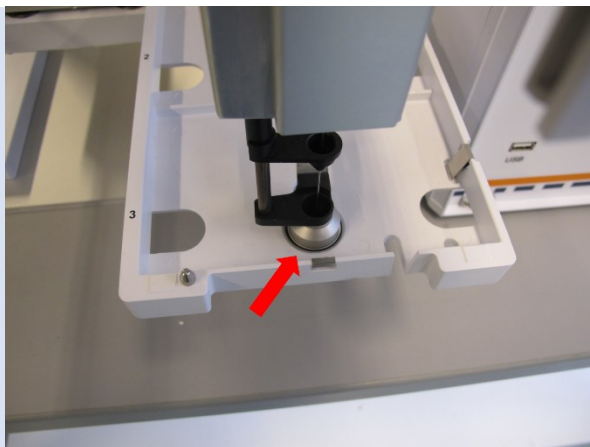

Check the position of the trayholder (see chapter 8.9).

OPTIONAL

Teach the position of the trayholder (see chapter 8.10).

3



Check the position of the agitator (see chapter 8.7).

OPTIONAL

Teach the position of the agitator (see chapter 8.8).

7.13 Warm-up phase after device powering-on

After switching on, the device is in the warm-up phase. The warm-up phase serves to protect the system from condensation after longer switch-off phases, e.g. transportation or storage.

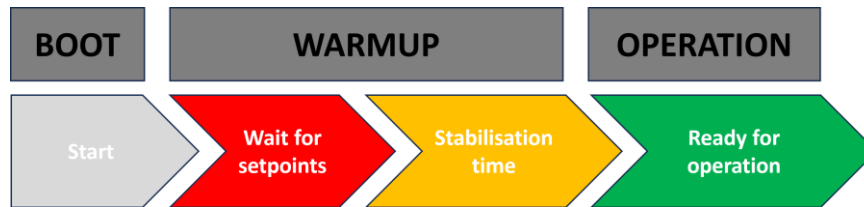

The warm-up phase is divided into two sub-phases:

Phase 1: Waiting for setpoints

All set temperatures must be reached and stable for 30 seconds before switching to phase 2.

Phase 2: Stabilization time

When all temperatures are stable, it takes up to one hour until the system is ready for operation.

The maximum duration of the warm-up phase is limited to 2 hours. The systems high voltage is switched off during this time.



INFORMATION!

The warm-up phase can be interrupted at any time by the user at his own risk.

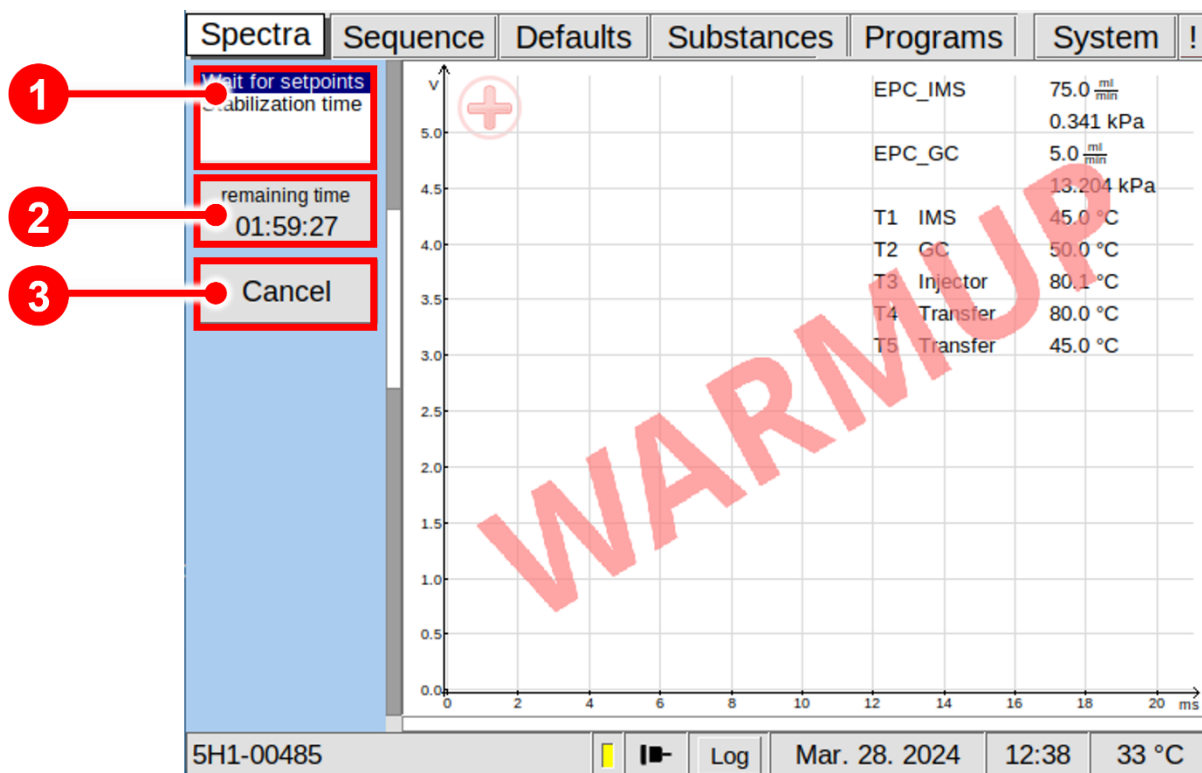

<p>1</p>	<p>Warm-up status Window</p>	<p>Displays the current state of the warm-up phase: Phase 1: Waiting for setpoints Phase 2: Stabilization time</p>
<p>2</p>	<p>Warm-up remaining time Window</p>	<p>Shows the remaining time of the warm-up phase</p>
<p>3</p>	<p>Warm-up Cancel button</p>	<p>The user can cancel the warm-up process with this button.</p>

7.14 Prepare the device for operation

Before using the device for the first time or after being disconnected from the nitrogen source for some time it must be cleaned to ensure proper operating conditions. In this case start the **cleaning mode**.

An appropriate cleaning period duration must be chosen depending on how long the device was switched off and on the extent of contamination. It is recommended to clean the device for at least **15 hours** before operating it for the first time. If the spectrum is not clean repeat the process. A **reference spectrum** for the evaluation can be found in the supplied **Analytical Approval**.



INFORMATION!

After the cleaning process the device needs at least **2 hours** to cool down the internal components to their required temperatures.

The duration of the cool down process is depending on the temperature default settings.

1

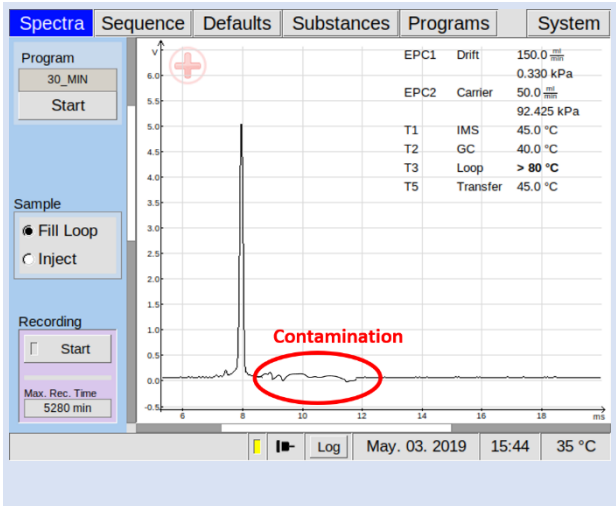

Inspect spectrum for contamination. Control the baseline. Start cleaning when contaminated. Contamination is indicated by peaks or the disappearing of the RIP.

2
Option

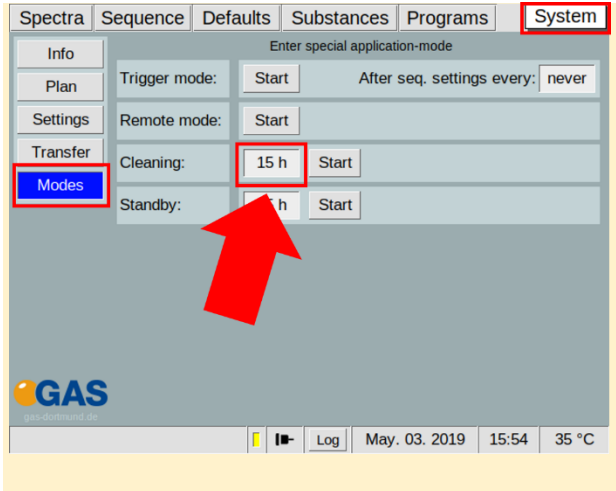

Select duration in hours:
System > **Modes** >
Cleaning: x h

3
Option

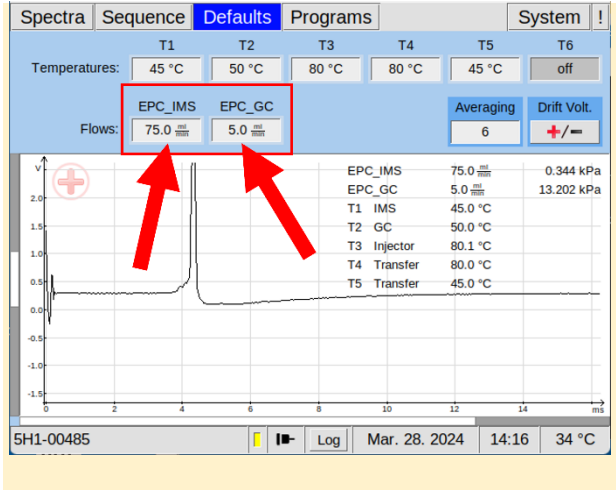

To speed up this process, increase flow rate of EPC_IMS and EPC_GC to their maximum values (e.g 500/150 ml/min):
Defaults > **EPC_IMS** >
EPC_GC

4

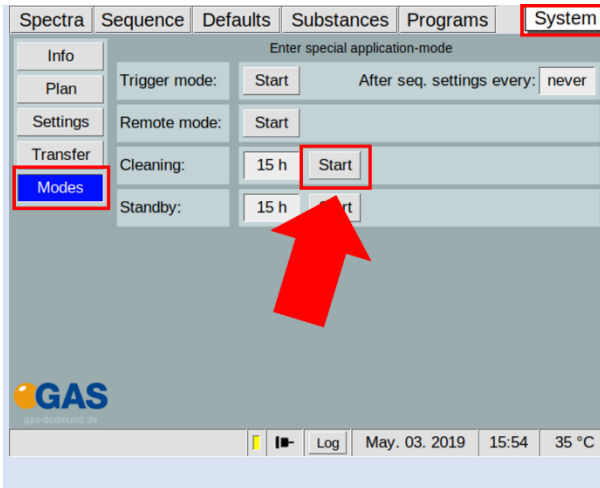

Start cleaning:

System > Modes >
Cleaning: > Start

5

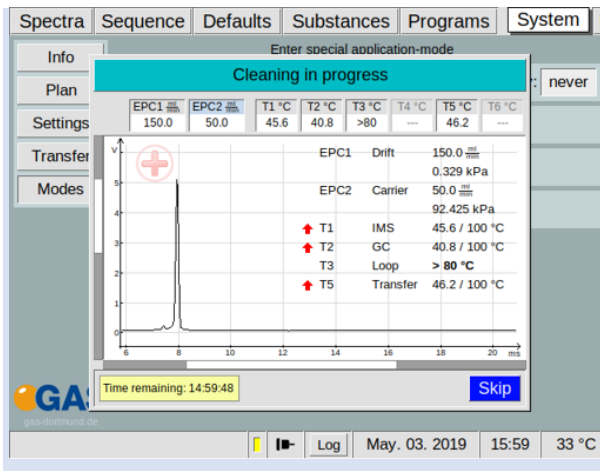

Wait until cleaning process is completed. The process can be stopped with Skip.

6

Analytical Approval

Type:	FlavourSpec®		
Serial number:	5H4-00485		
Working principle:	Ion Mobility Spectrometry (IMS)		
Ionisation:	β-radiation source (Tritium (³H))		
Sensor number:	00060165		
Column type:	MXT-5, 15m L, 0.53mm ID, 1µm FT		
Firmware Version:	4.60		
Year of construction:	2024		
Autosampler Typ:	PAL3 RSI SII		
Autosampler Serial Number:	703607		
Autosampler Firmware:	3.1.25		

Measurement conditions			
Drift gas flow rate:	75 mL/min		
Carrier gas flow rate:	1 sec @ 5 mL/min, 30 min > 50 mL/min		
Drift gas type:	Nitrogen 5.0	Carrier gas type:	Nitrogen 5.0
Drift gas pressure:	0.569 kPa	Carrier gas pressure:	12.699 kPa
IMS temperature:	45 °C	Column temperature:	40 °C
Injector temp.:	80 °C	RIP voltage:	positive
Trigger duration:	100 µs	Averages:	6
Sample in headspace:	1 mL	Sample injection volume:	300 µL
Testmix sample:	Testmix_M3	Concentration range:	162-164 ppb
Incubation Temperature:	60 °C	Measurement runtime:	30 min
Incubation Time:	20 min	Program:	QC
PAL Method and Job:	Testmix	Date of measurement:	05.08.2024

RIP (4.47 ms, 4.95 V)

Page 1 of 4

After all temperatures reached the default values inspect visually the current spectrum and compare it with the reference spectrum of the Analytical Approval. **The RIP should reach ~80% of the RIP height displayed in the delivered Analytical Approval of the device under same measurement conditions of G.A.S. The assessment of the readiness to measure is additionally supported by the system.**

If not check the gas quality and/or install additional purification cartridges and start the cleaning procedure again.



INFORMATION!

The device is delivered with an acceptance snapshot. This snapshot defines the system performance during device acceptance and is used to assess the readiness for measurement. Any deviations from this are displayed in the Error Information Window. **The default values can be adjusted by the customer.**



INFORMATION!

The system is preset with the gas type nitrogen for drift gas and carrier gas. Normally, nitrogen or synthetic air in quality 5.0 is used.
The default values can be adjusted by the customer.

8 System Operation (How to...)

8.1 Measurement Requirements



INFORMATION!

Only use the original accessories supplied with the device.

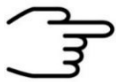

INFORMATION!

Make sure that the gas quality is 5.0 (99.999%) or better.

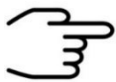

INFORMATION!

Only use stainless steel pressure reducer.



INFORMATION!

Make sure that the spectrum is clean a without contamination.



WARNING!

Do not introduce any liquids. This can destroy the device.



INFORMATION!

Make sure that that all temperature-, flow- and pressure values have reached their default value and are stabilized.



INFORMATION!

Make sure that the correct gas types are set for drift gas and carrier gas. The default setting is nitrogen.

8.2 Adjusting the gas type settings



INFORMATION!

The electronic pressure regulators for drift gas (EPC-IMS) and carrier gas (EPC-GC) are preset with the gas type nitrogen. If other gas types are used, these must be adapted by the user. Usually nitrogen or synthetic air of quality 5.0 is used.

1

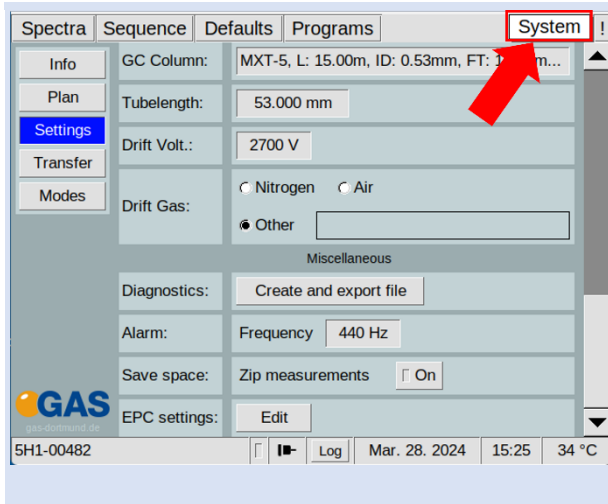

Select **System** to move to the **Settings**.

2

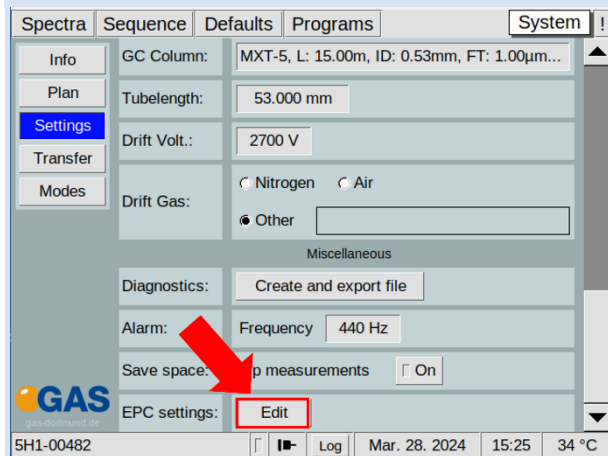

Select **EPC settings** and press **Edit**.

3

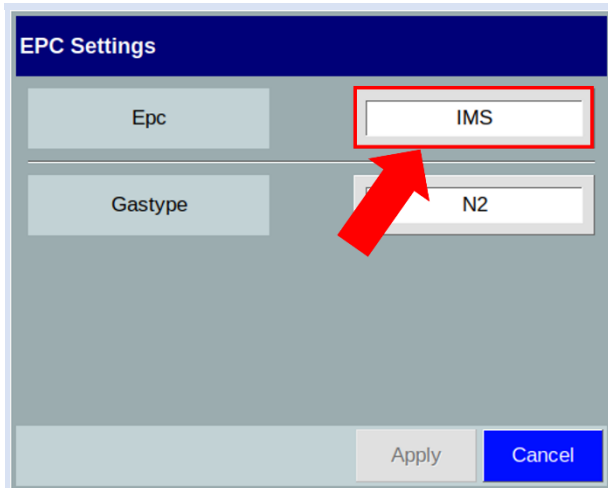

Select the available EPCs. **IMS** (drift gas) and **GC** (carrier gas) can be selected in the FlavourSpec®.

4

EPC Settings

Epc IMS

Gastype N2

Apply Cancel

Select the gas type. All available gas types of the electronic pressure controllers are displayed. Usually **nitrogen (N2)** or **synthetic air (Air)** is used.

5

EPC Settings

Epc IMS

Gastype N2

Apply Cancel

Press **Apply** to confirm.

8.3 Select Measurement Program



INFORMATION!
 Selection and input of a measurement program is possible via graphical user interface of the FlavourSpec® using the Touchscreen and/or rotary knob at the front of the device.

1

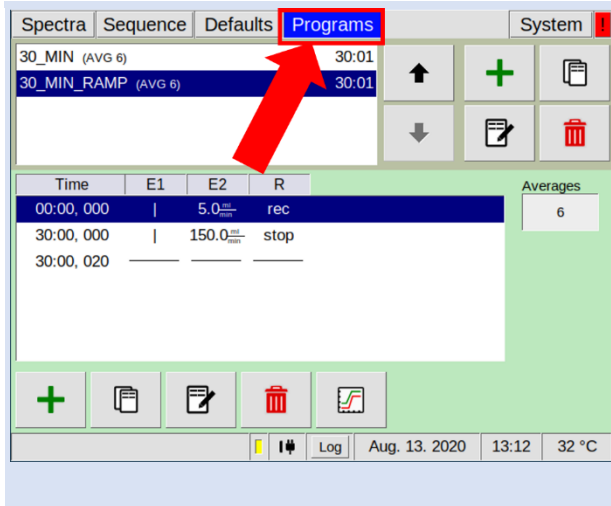

Select **Programs** to move to the program window.

2

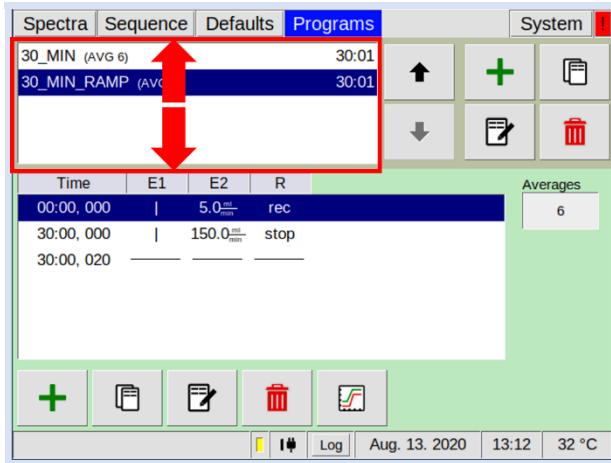

Scroll through the programs with the **rotary knob**.

3

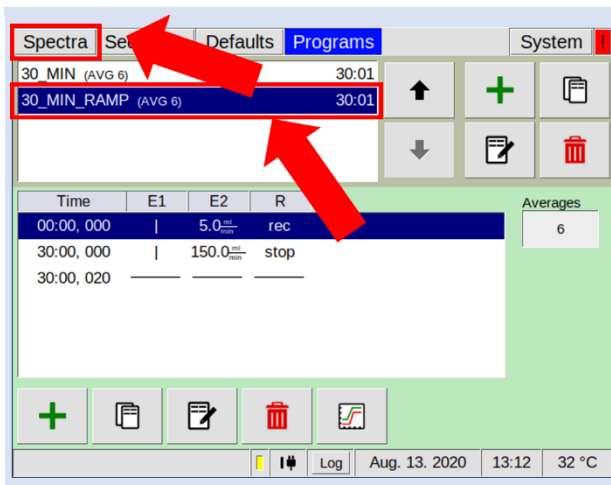

Select a measurement program. Select **Spectra** to move to the Spectra window.

4

The **actual measurement program** is shown.

8.4 Create a Measurement Program

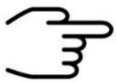

INFORMATION!

Selection and input of a measurement program is possible via graphical user interface of the FlavourSpec® using the Touchscreen and/or rotary knob at the front of the device.

1

Time	V1	R	E1	E2	P1
00:00, 000		rec			
00:00, 500	open				
00:12, 520	close				
00:20, 000				2.0 $\frac{mL}{min}$	
05:00, 000		stop		75.0 $\frac{mL}{min}$	
05:00, 020					

Select:

Programs

To create a new program select the button

2

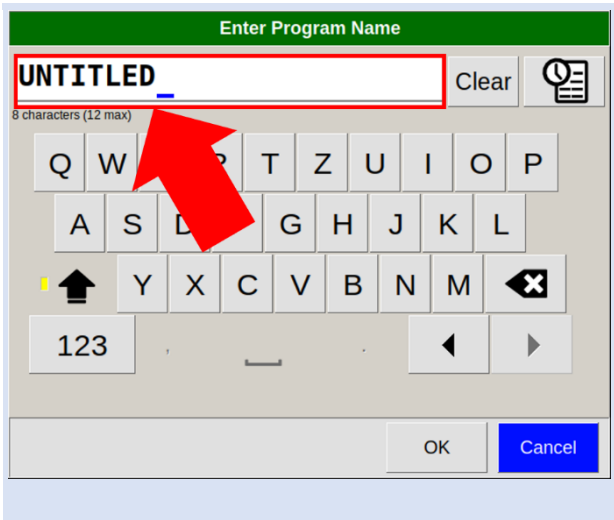

Enter a new program name or use the default name.

3

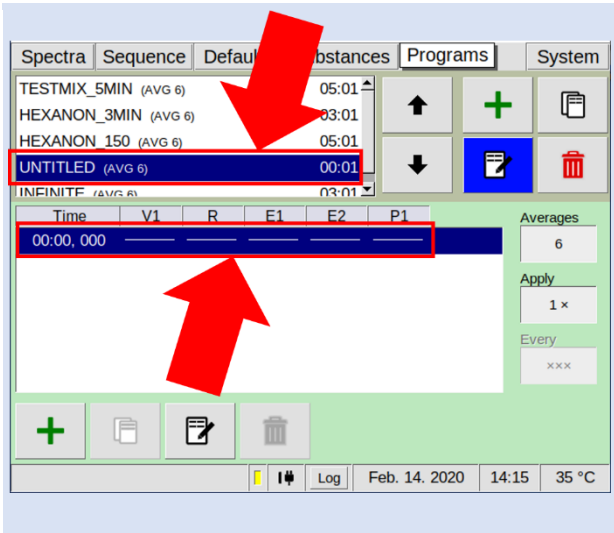

The program end time is displayed as the final line.

4

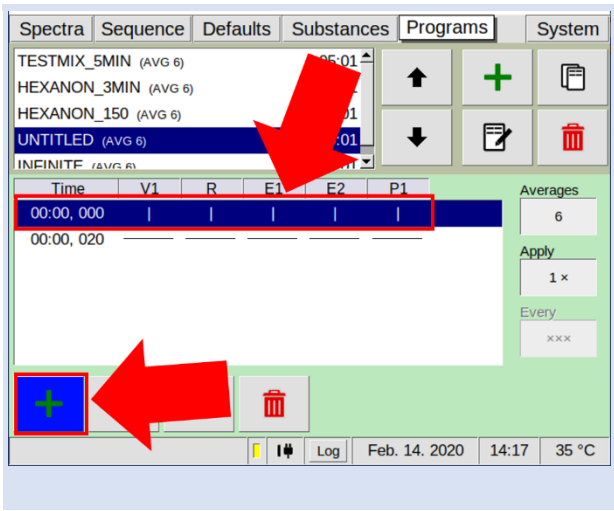

To create a new program action line select the button 

5

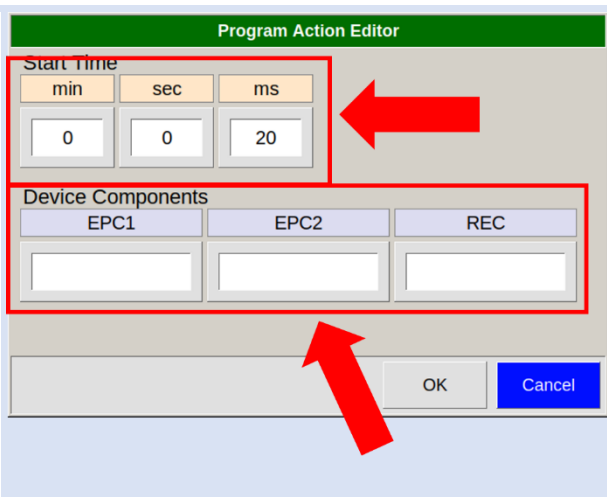

This line can be filled with values.

For more information (see [chapter 6.5.3](#)).

6

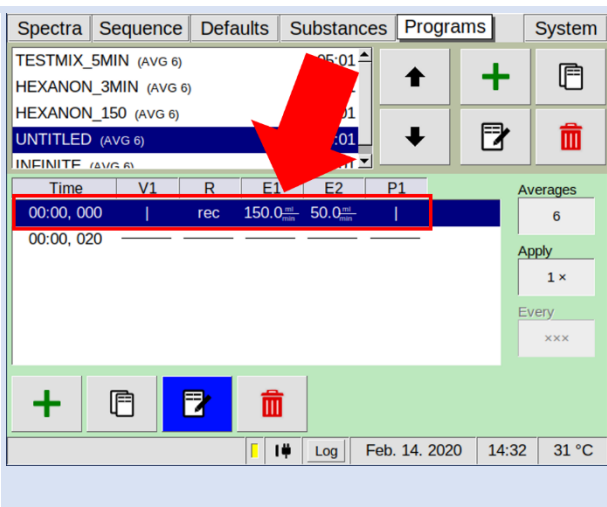

After the necessary values have been entered, repeat step 4 and 5 to create the next program action lines.

7

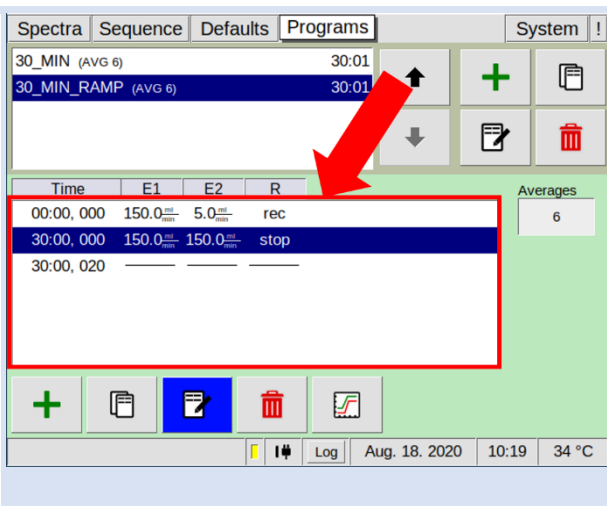

A complete program sequence can be created line by line.



INFORMATION!

The device is delivered with standard programs that can be adapted to your needs.

Customer-specific programs can also be created optionally.

8.5 Check Injector Position

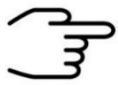

INFORMATION!

It is recommended to check the position of the injector after every transport of the device. A false position can damage the syringe. When using the Headspace-Tool it is recommended to use the Injector Adapter.

1

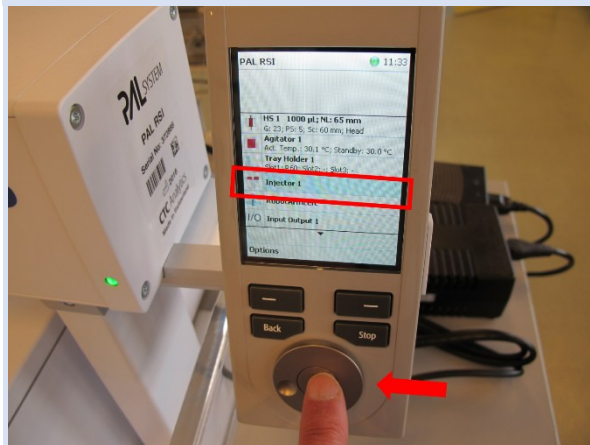

On the PAL RSI main screen select **Injector 1**.

2

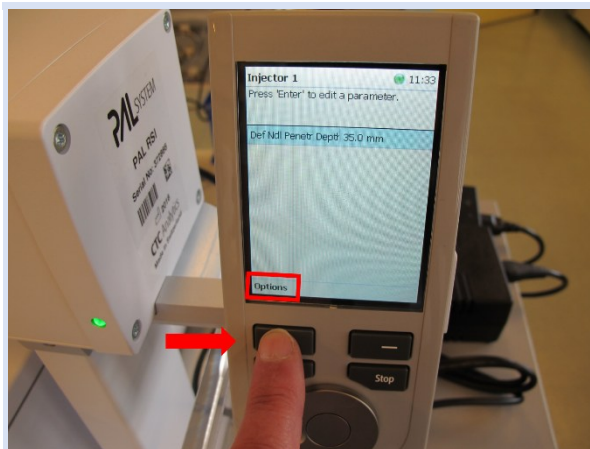

With the **left function key** select **Options**.

3

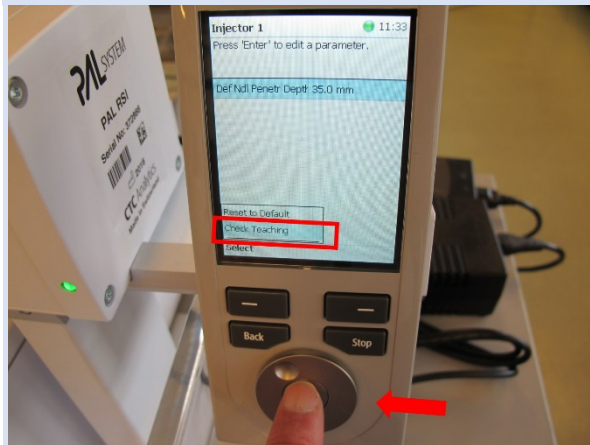

In **Options** menu select **Check Teaching**.

4



With the **right function key** select **Check**.

5

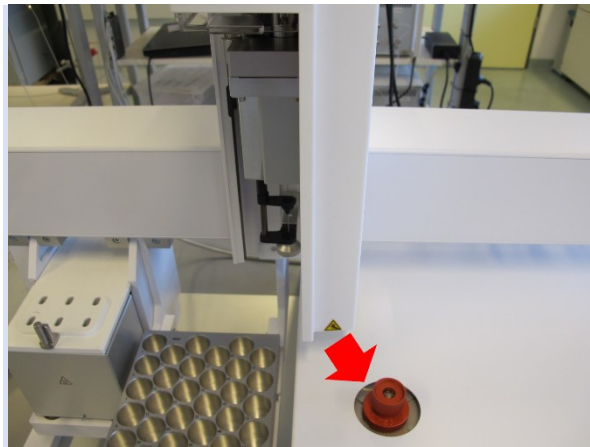

After a **warning signal** the **arm moves** to actual injector position.

6

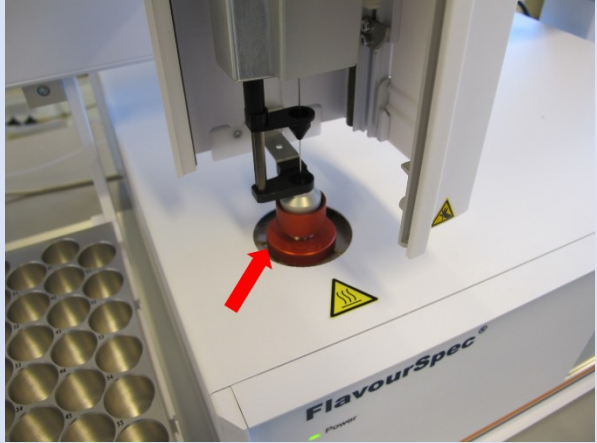

The magnetic adapter of the tool and the injector adapter has to fit. Otherwise, the injector position must be taught (see chapter 8.6).

7



With the right function key select Next.

8



With the right function key select OK.

9



Select the **Back** button to go to the main screen.

8.6 Teach Injector Position



INFORMATION!

The teaching procedure is only available in **Extended User Level**. When using the Headspace-Tool it is recommended to use the Injector Adapter. The Injection Penetration Depth Value must be 35.0 mm. Do not modify. When using the ITEX-Tool (optional) the Injector Adapter needs to be removed. The Injection Penetration Depth Value must be 35.0 mm. Do not modify.

Teach the Injector Position after every tool change.



WARNING!

The Injector can become very hot. Risk of burning. Use heat-resistant gloves.

1

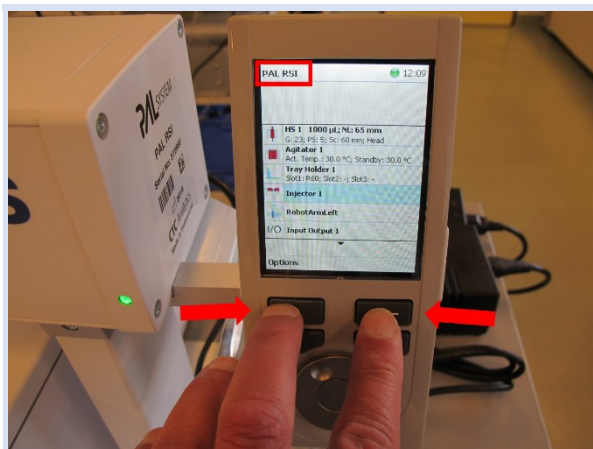

Press **both function keys** simultaneously to go to the **Change Access** screen.

2



Select **Extended User Level**.

Select **Back** to go to the main screen.

3



In main screen select **Injector1**.

4

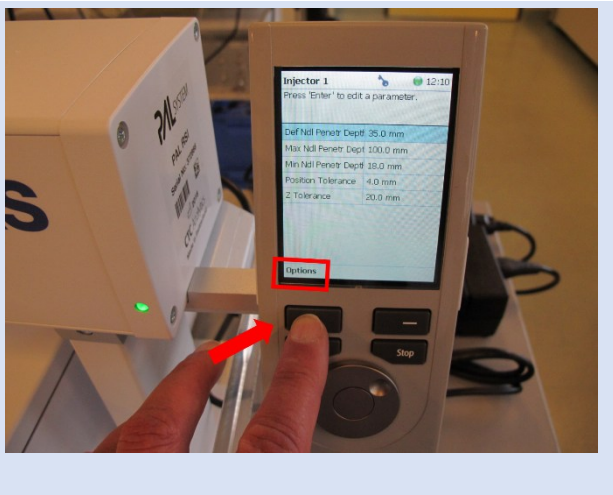

With the **left function key** select **Options**.

5

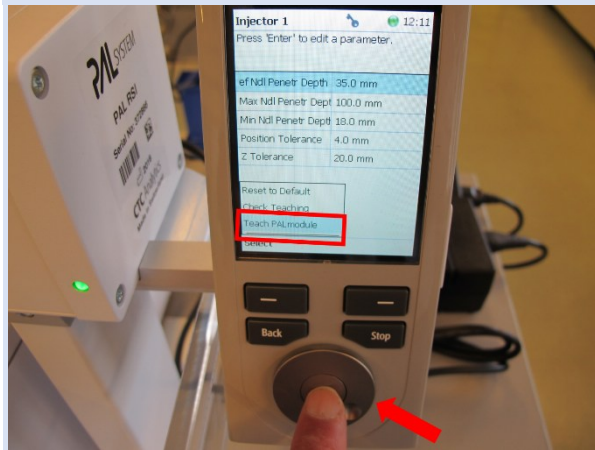

In **Options** menu select **Teach PALmodule**.

6

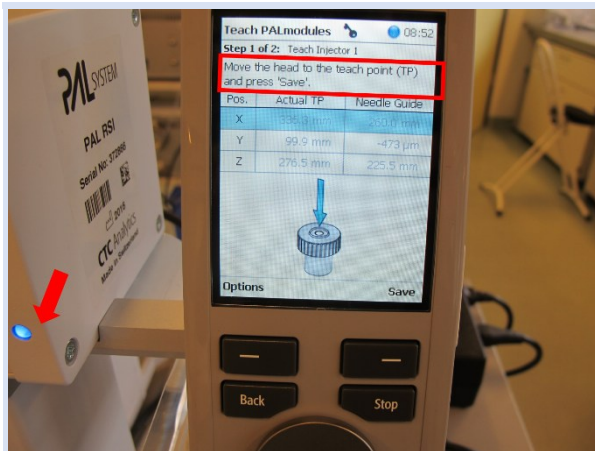

If the status light has change to blue follow the instructions on the screen:
Move the head to the teach point (TP)...

7

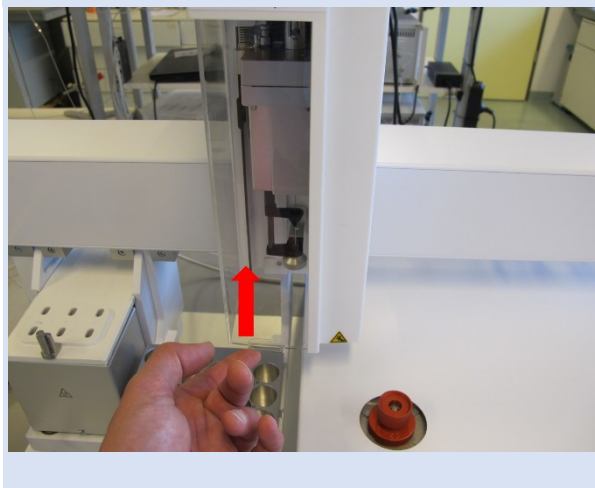

Move the protective cover to its upper position.

8



Move the arm to the injector position, ...

9

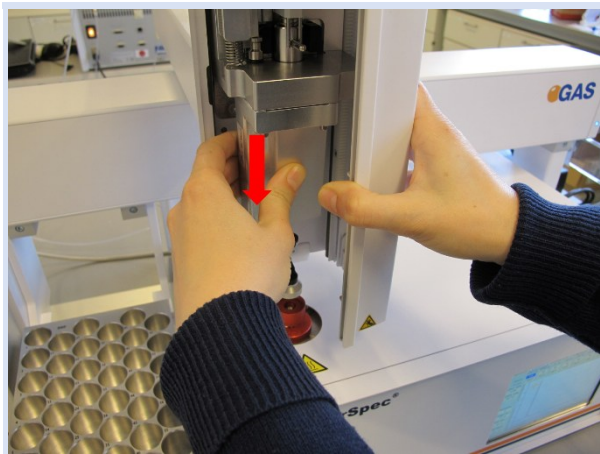

...move the tool down to the injector position...

10

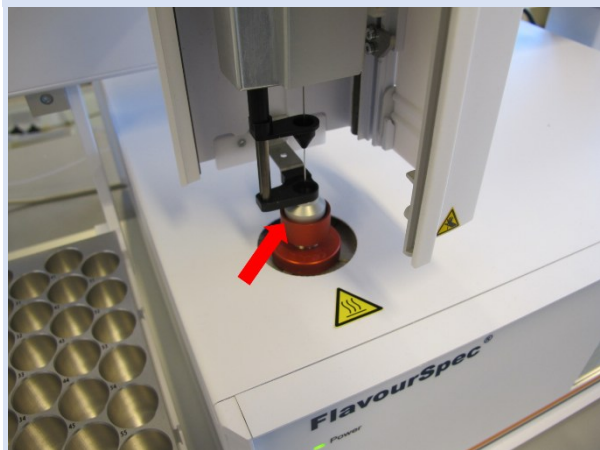

...and position the magnetic ring into the injector adapter.

11



With the **right function key** select **Save**.

12

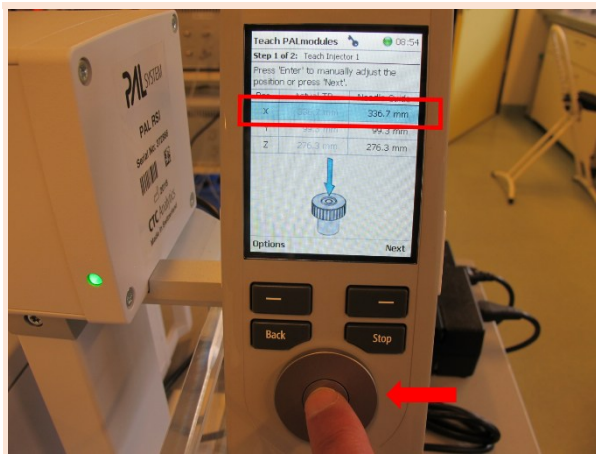

OPTIONAL:
To manually adjust the position select the X-, Y- or Z-axis.

13



The values can be adjust in 0.1 mm steps.

14



Confirm the value by pressing the **rotary knob**.

15

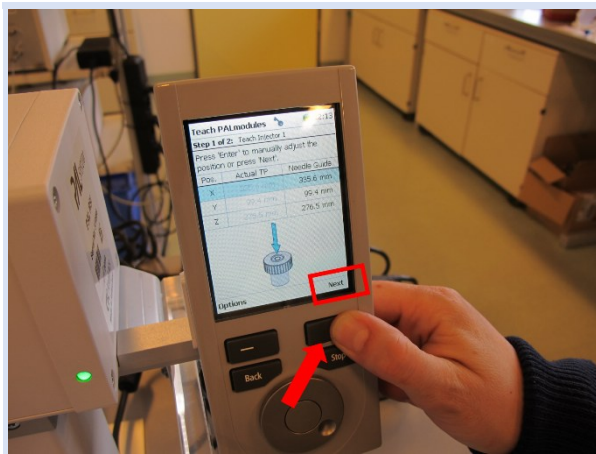

With the **right function key** select **Next**.

16

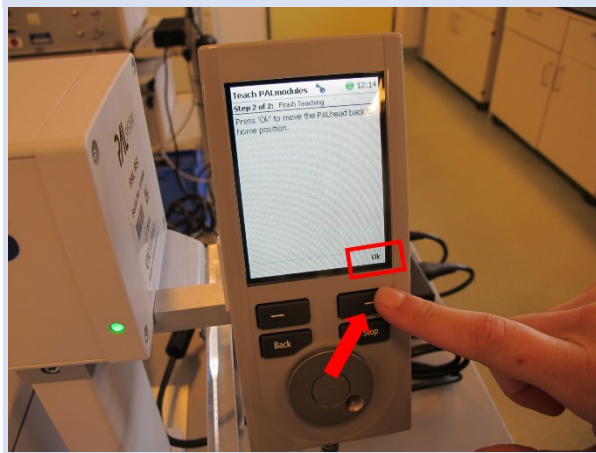

With the **right function key** select **OK**.

17



Select the **Back** button to go to the main screen.

8.7 Check Agitator Position



INFORMATION!

It is recommended to check the position of the agitator after every transport of the device.

1

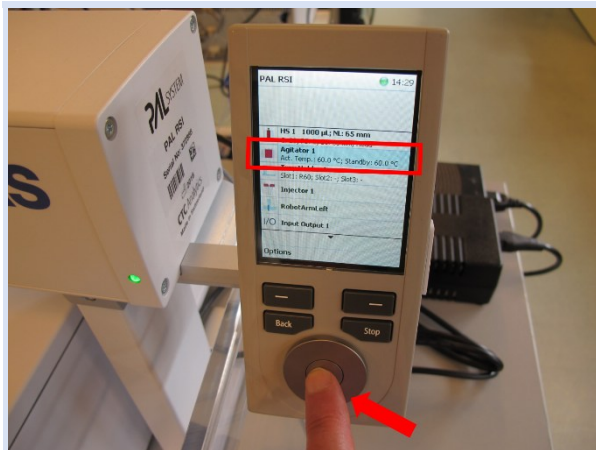

On the PAL RSI main screen select **Agitator 1**.

2

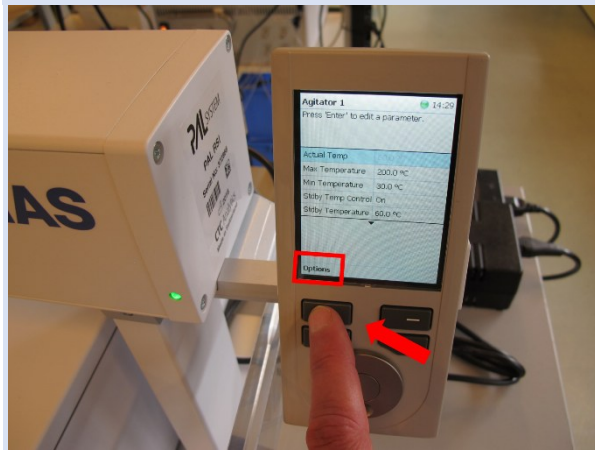

With the **left function key** select **Options**.

3

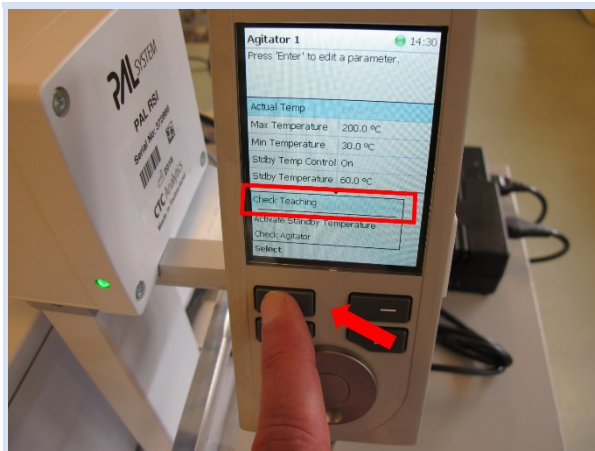

In **Options** menu select **Check Teaching**.

4

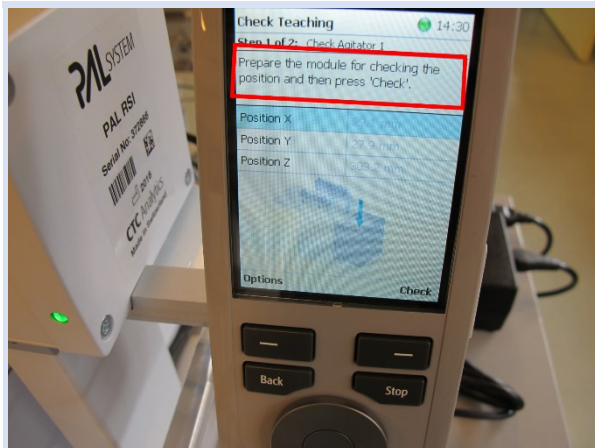

Follow the instruction on the screen:
Prepare the module...

5

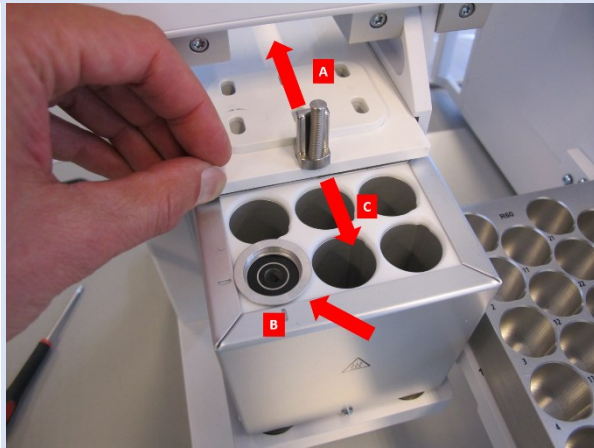

Move the cover back **A**, insert the teaching tool in position 1 **B** and close the cover **C**.

6



With the **right function key** select **Check**.

7

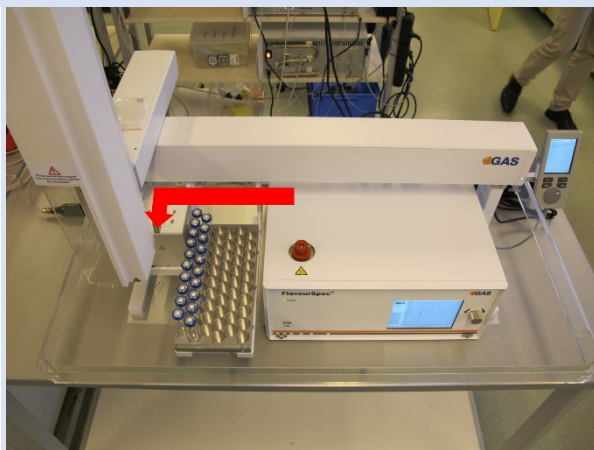

After a **warning signal** the **arm moves** to the actual agitator position.

8



The magnetic adapter of the tool and the teaching tool has to fit. Otherwise, the agitator position must be taught (see chapter 8.5).

9

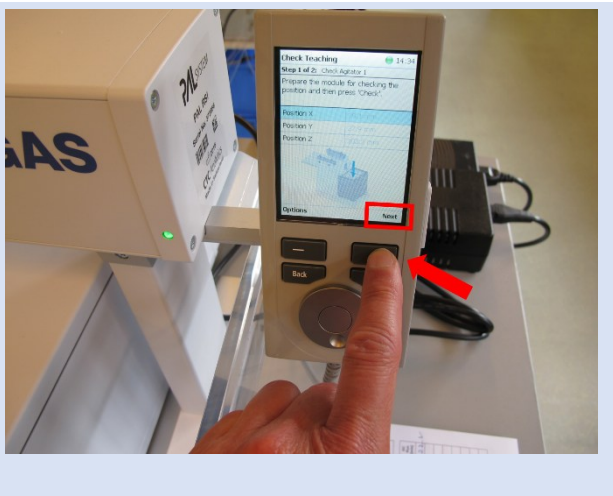

With the right function key select Next.

10

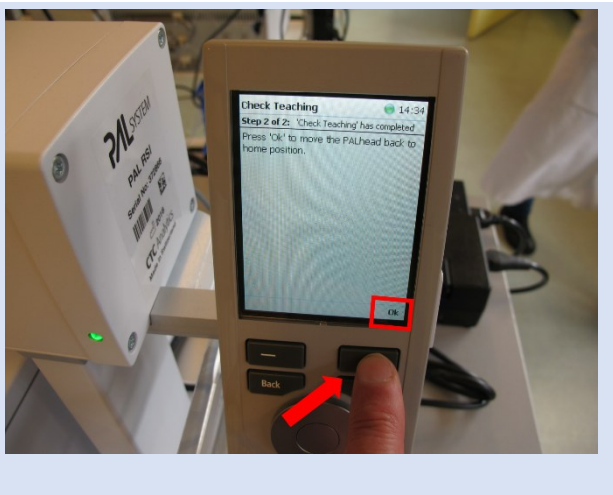

With the right function key select OK.

11

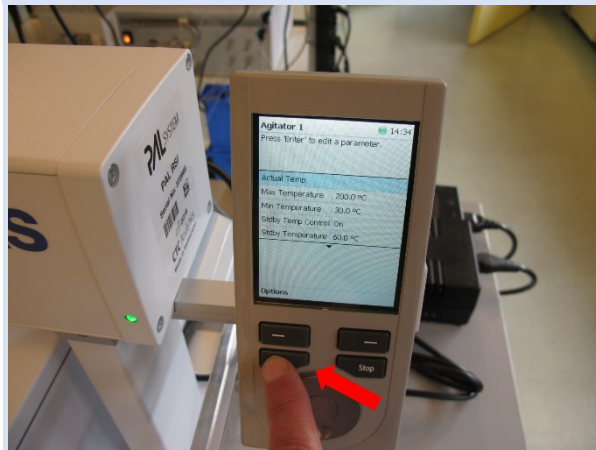

Select the **Back** button to go to the main screen.

8.8 Teach Agitator Position



INFORMATION!

The teaching procedure is only available in **Extended User Level**.



WARNING!

The agitator can become very hot. Risk of burning. Use heat-resistant gloves.

1



Press **both function keys** simultaneously to go to the **Change Access screen**.

2



Select **Extended User Level**.

Select **Back** to go to the main screen.

3

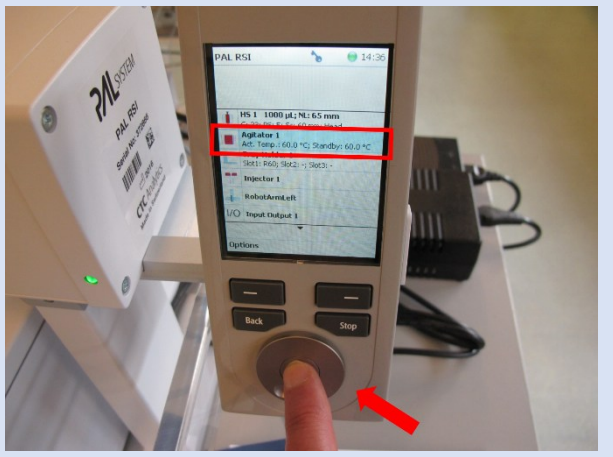

In main screen select **Agitator1**.

4

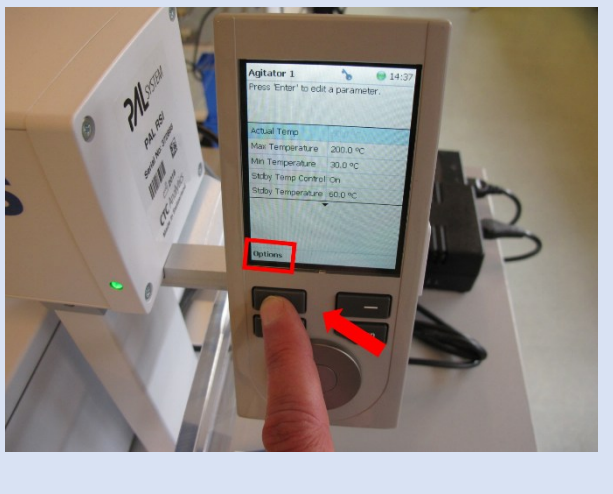

With the **left function key** select **Options**.

5

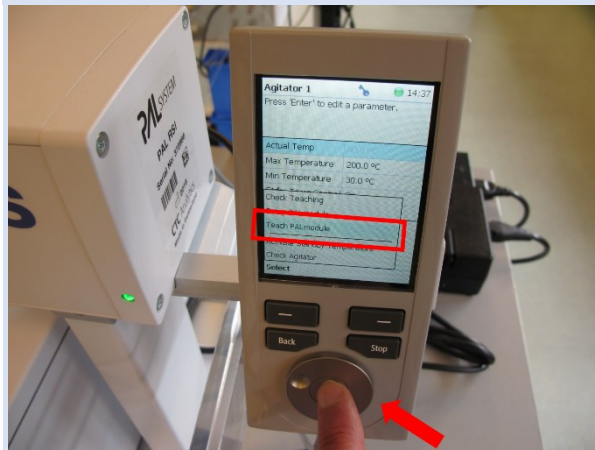

In **Options** menu select **Teach PALmodule**.

6

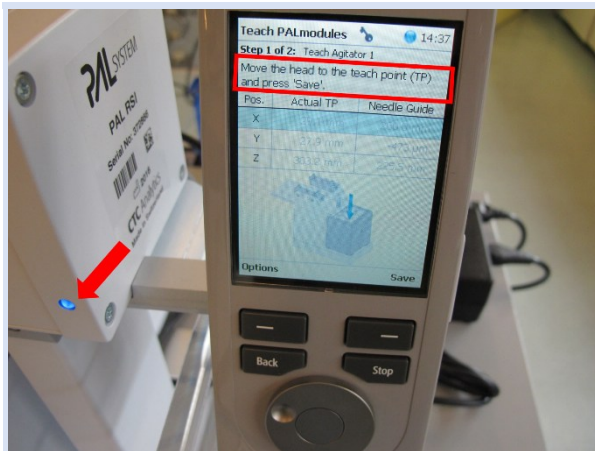

If the status light has change to blue follow the instructions on the screen:
Move the head to the teach point (TP)...

7

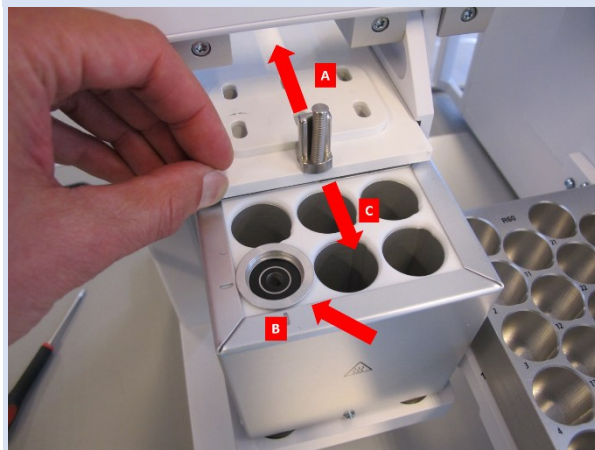

Move the cover back **A**, insert the teaching tool in position 1 **B** and close the cover **C**.

8

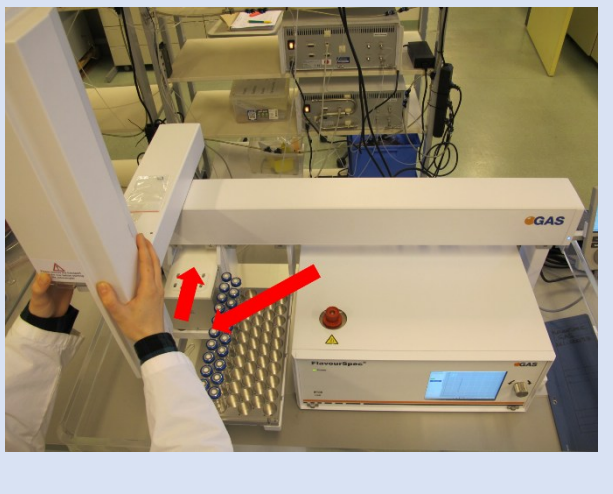

Move the arm to the Agitator, ...

9



...move the tool down to the agitator position and position the magnetic ring into the teaching tool.

10

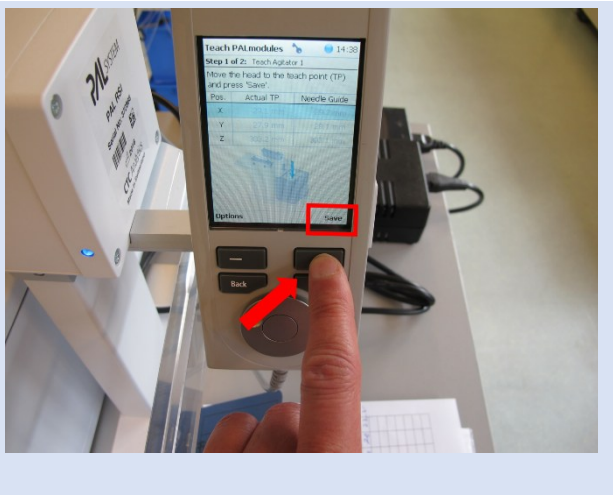

With the **right function key** select **Save**.

11

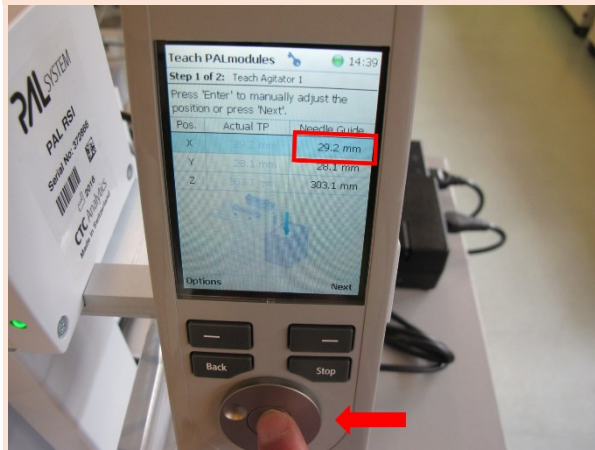

OPTIONAL:
To manually adjust the position select the X-, Y- or Z-axis.

12



The values can be adjust in 0.1 mm steps.

13

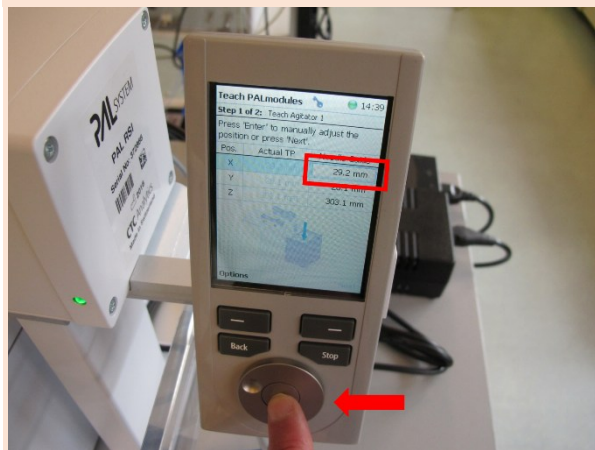

Confirm the value by pressing the **rotary knob**.

14



With the **right function key** select **Next**.

15

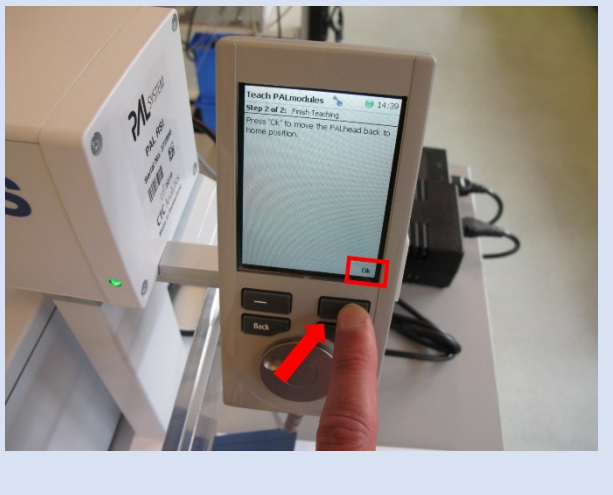

With the **right function key** select **OK**.

16

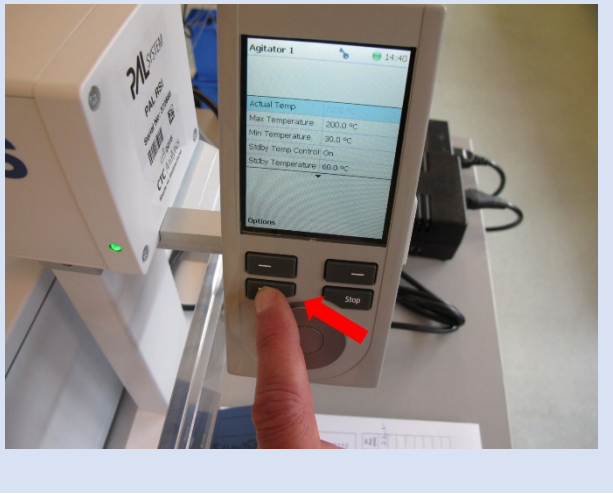

Select the **Back** button to go to the main screen.

8.9 Check Tray Reference Position



INFORMATION!

It is recommended to check the position of the agitator after every transport of the device. A false position can damage the syringe.

1

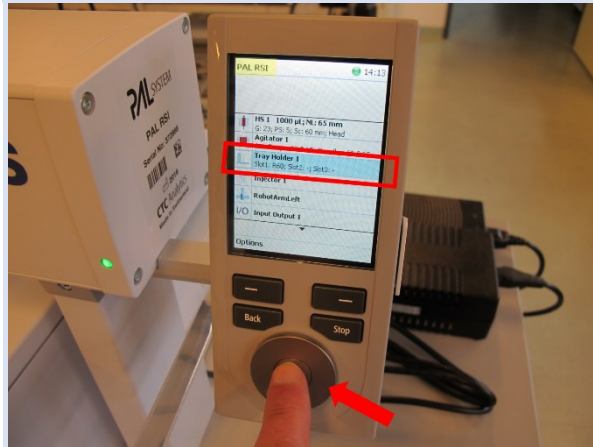

On the PAL RSI main screen select **TrayHolder 1**.

2

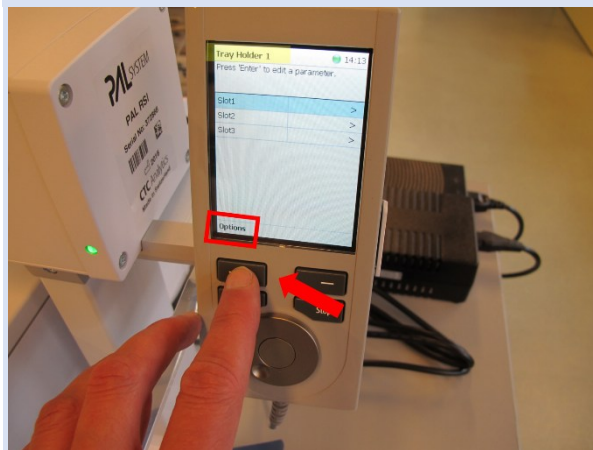

With the **left function key** select **Options**.

3

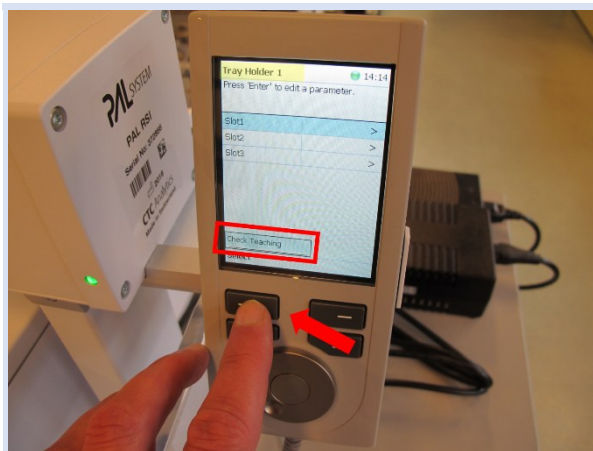

In **Options** menu select **Check Teaching**.

4

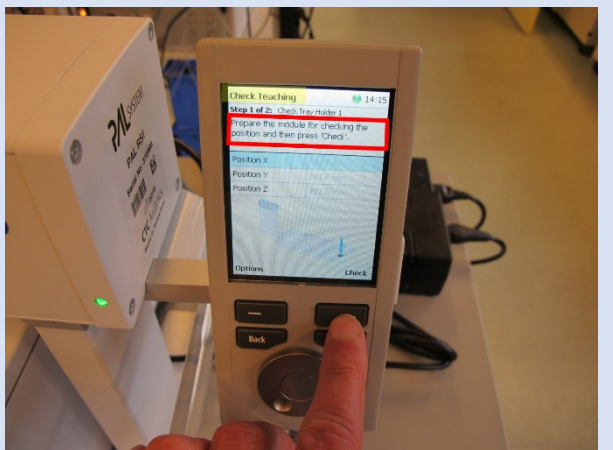

Follow the instruction on the screen:
Prepare the module...

5



Remove the tray.

6



The figure shows the teaching point of the tray holder.

7

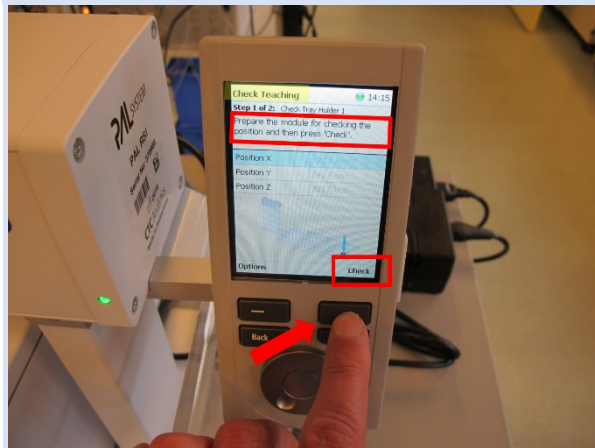

With the **right function key** select **Check**.

8

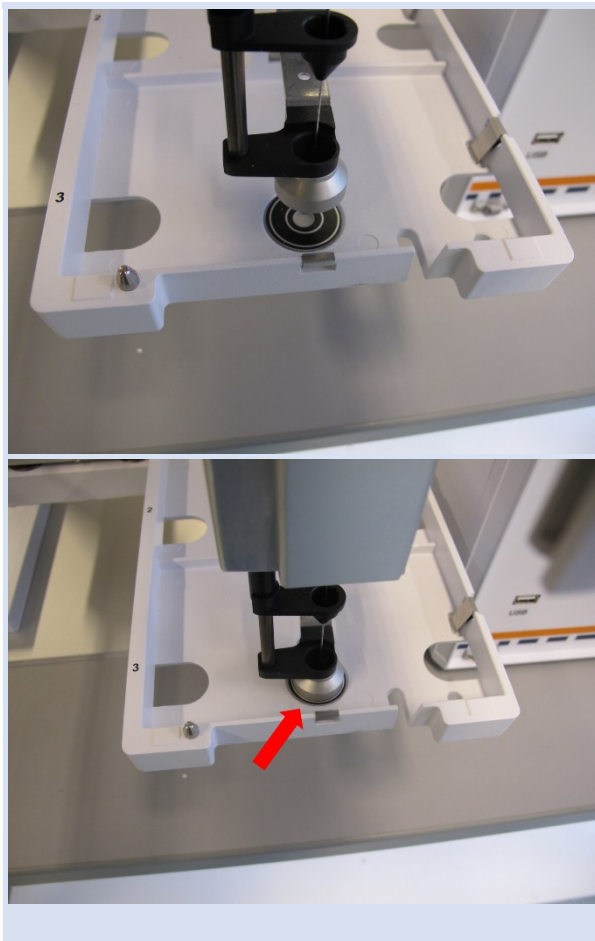

After a **warning signal** the **arm moves** to the actual teaching point.

The magnetic adapter of the tool and the teaching point has to fit. Otherwise the tray reference position must be taught (**see chapter 8.10**).

9

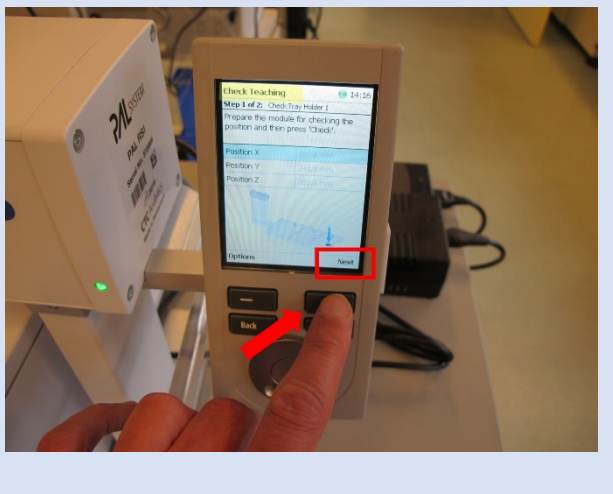

With the **right function key** select **Next**.

10

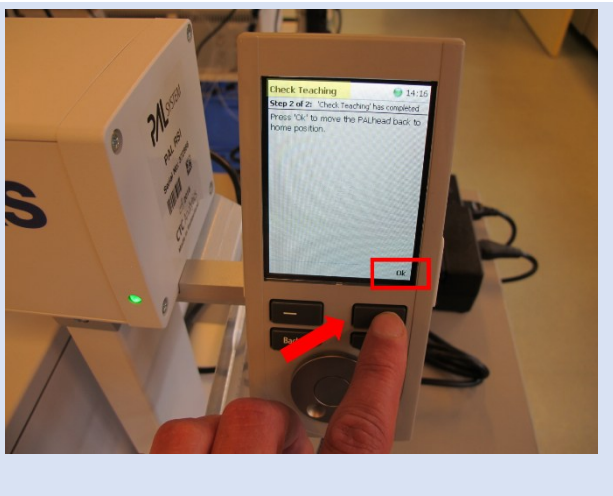

With the **right function key** select **OK**.

11

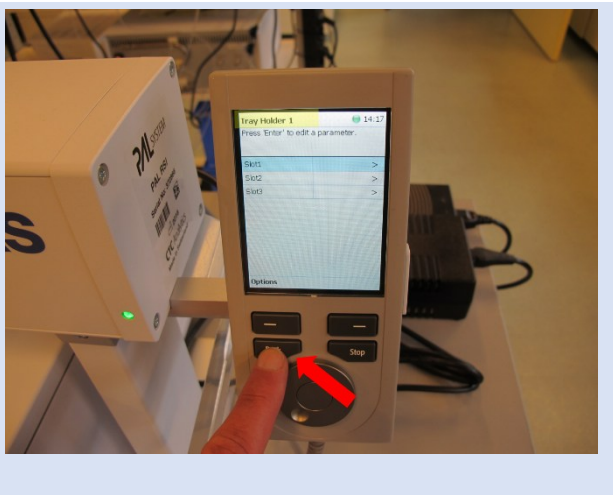

Select the **Back** button to go to the main screen.

8.10 Teach Tray Reference Position



INFORMATION!

The teaching procedure is only available in **Extended User Level**.

1

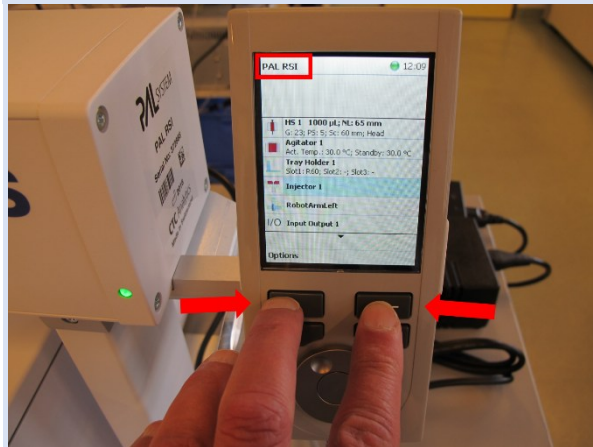

Press **both function keys** simultaneously to go to the **Change Access** screen.

2



Select **Extended User Level**.

Select **Back** to go to the main screen.

3

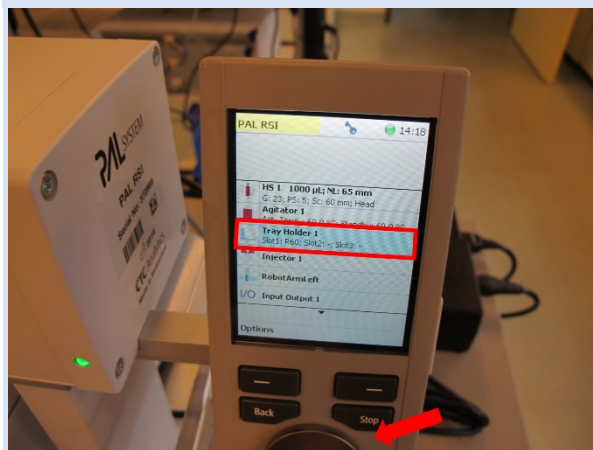

In main screen select **Tray Holder 1**.

4

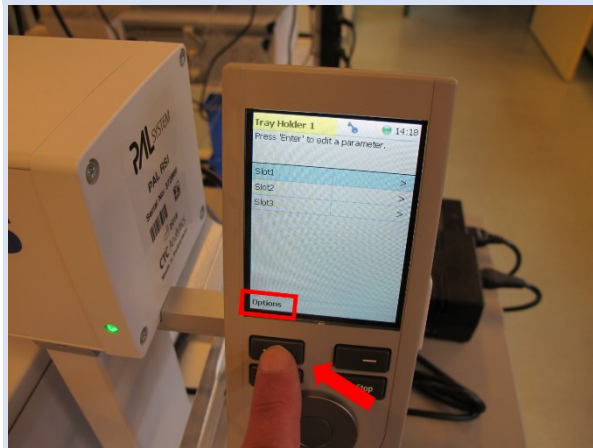

With the **left function key** select **Options**.

5

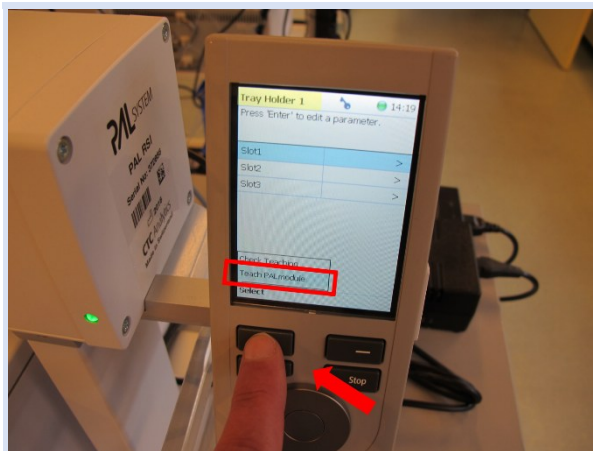

In **Options** menu select **Teach PALmodule**.

6

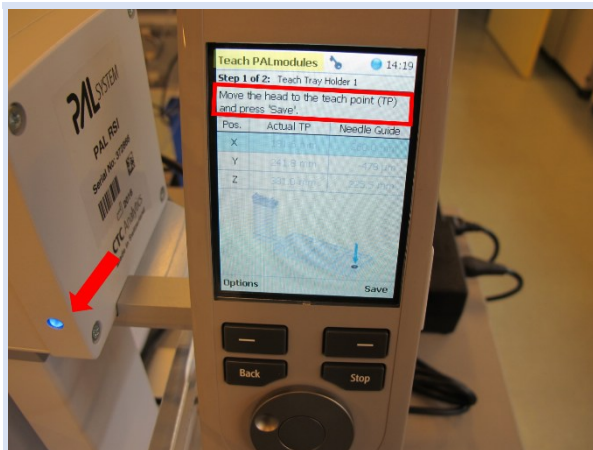

If the status light has change to blue follow the instructions on the screen:
Move the head to the teach point (TP)...

7

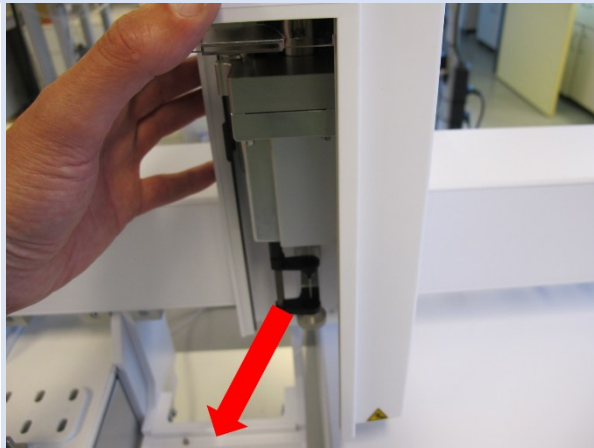

Move the arm to the tray holder position, ...

8

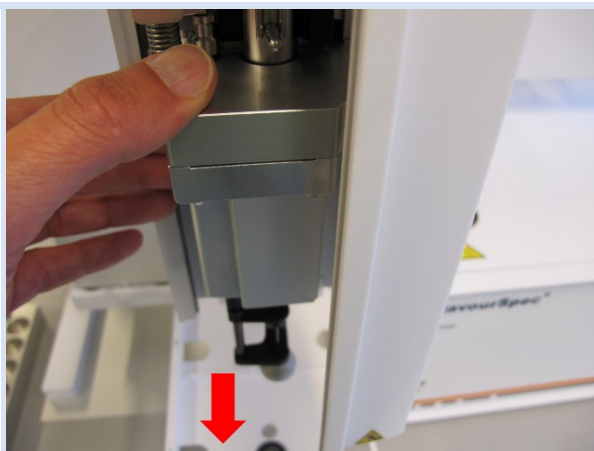

move the tool down to the teaching point ...

9

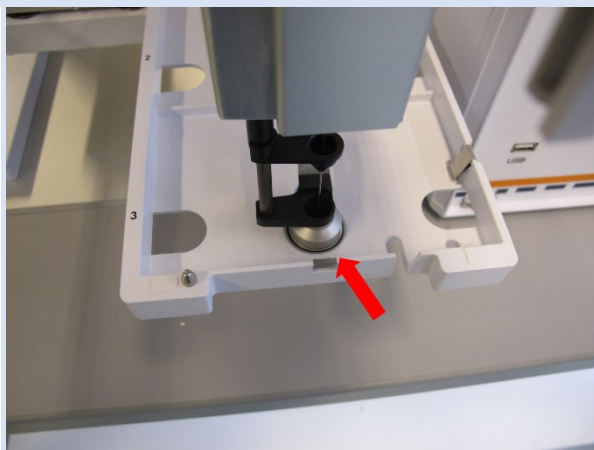

and position the magnetic ring onto teaching point.

10

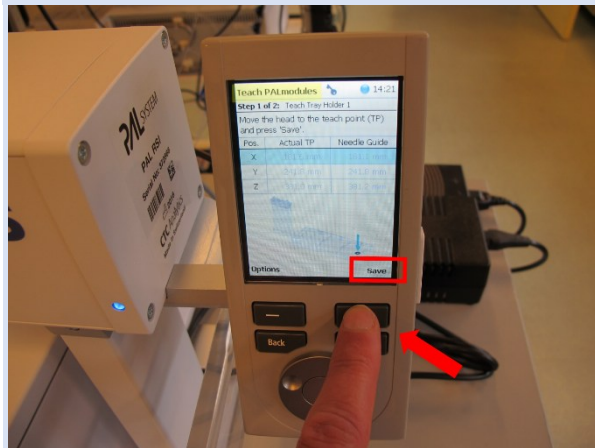

With the **right function key** select **Save**.

11

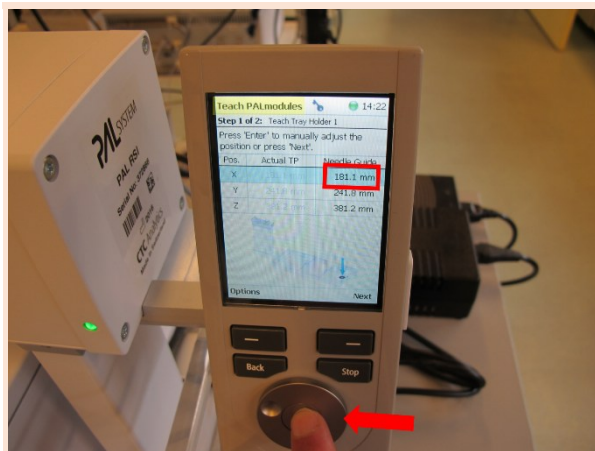

OPTIONAL:
To manually adjust the position select the X-, Y- or Z-axis.

12

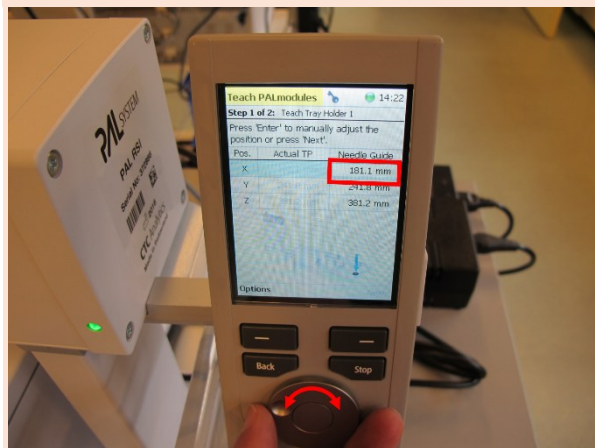

The values can be adjust in 0.1 mm steps.

13

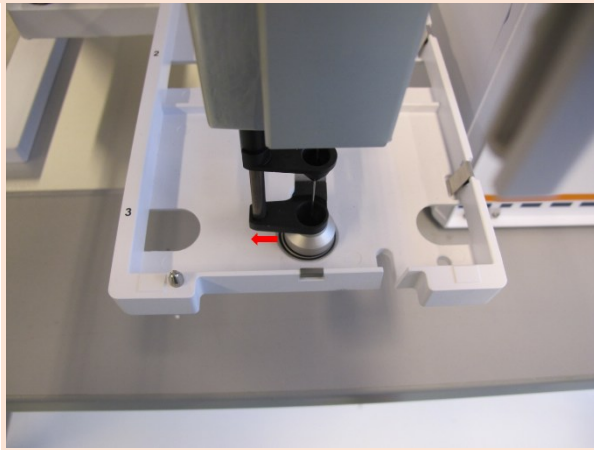

The figure shows the x-axis adjustment.

14

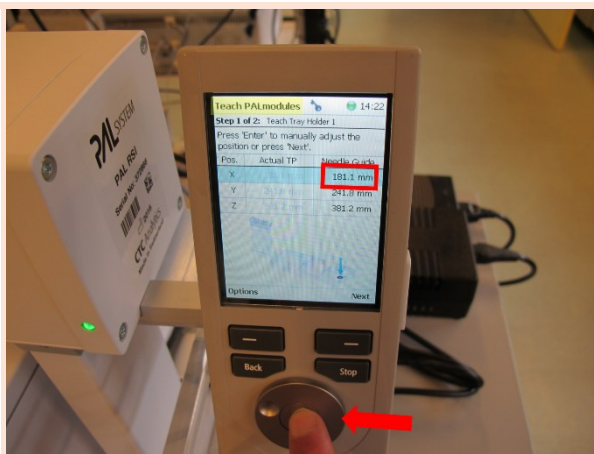

Confirm the value by pressing the **rotary knob**.

15

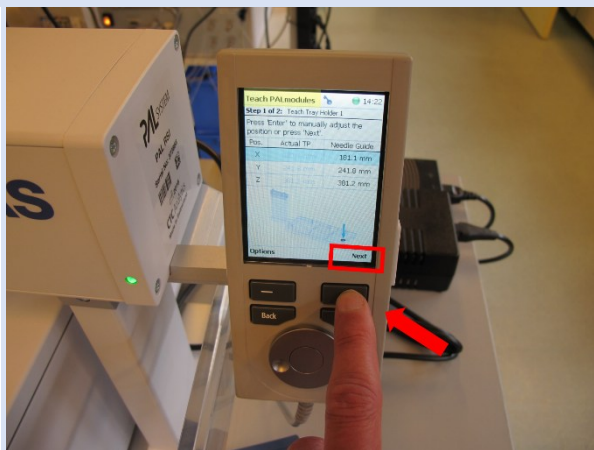

With the **right function key** select **Next**.

16

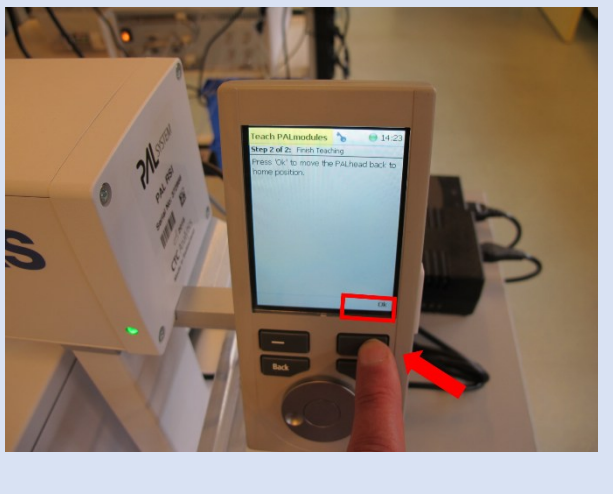

With the **right function key** select **OK**.

17

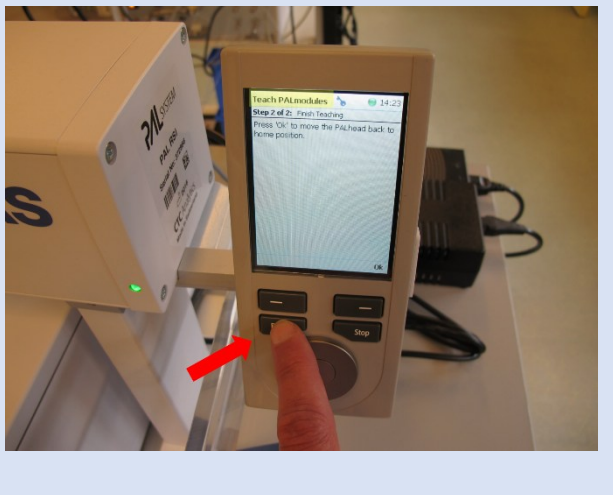

Select the **Back** button to go to the main screen.

18

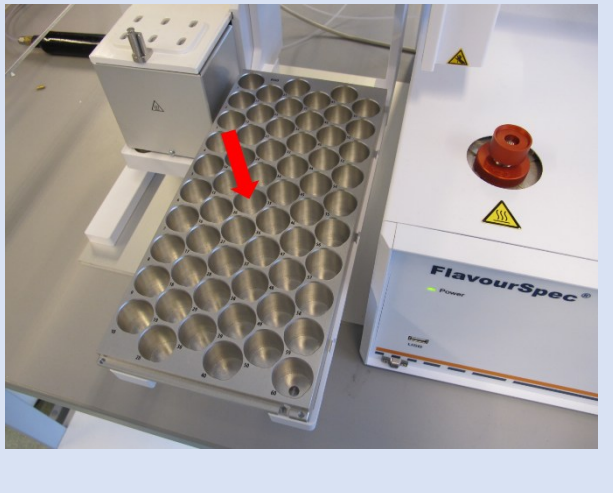

Insert the tray.

8.11 Create a New Job



INFORMATION!

A job contains the amount the position of the sample vials in the tray and the sample volume that will be injected. A Job is always connected to a method (see chapter 8.4 and chapter 8.13).

1

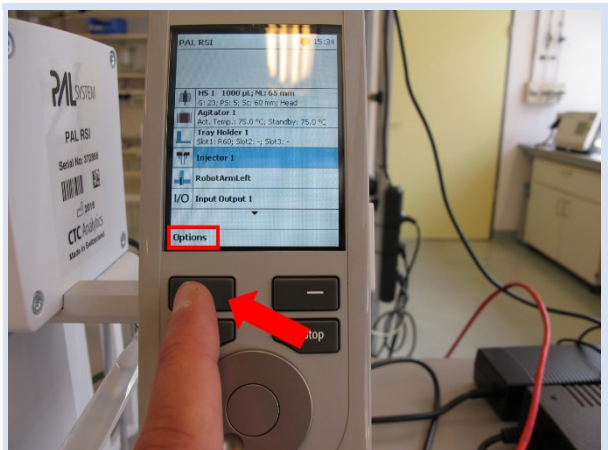

With the **left function key** select **Options**.

2

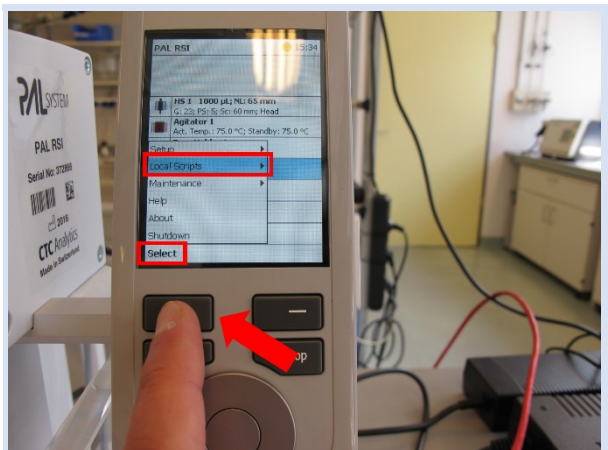

In **Options** menu select **Local Scripts**.
With the **left function key** select **Select**.

3

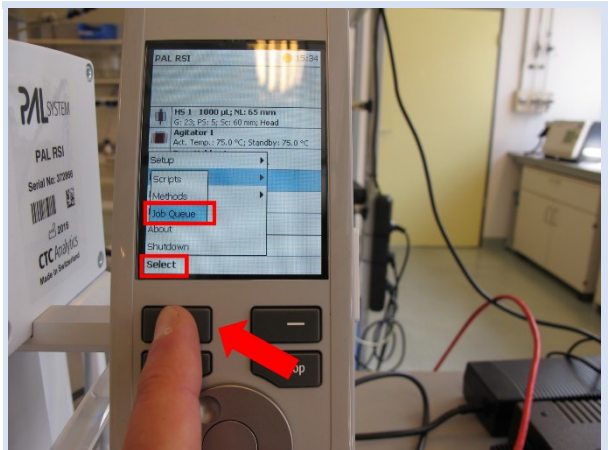

In **Options** menu select **Job Queue**.
With the **left function key** select **Select**.

4

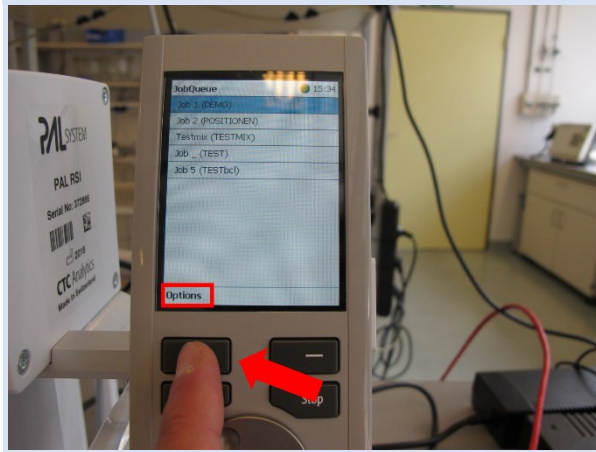

With the **left function key** select **Options**.

5

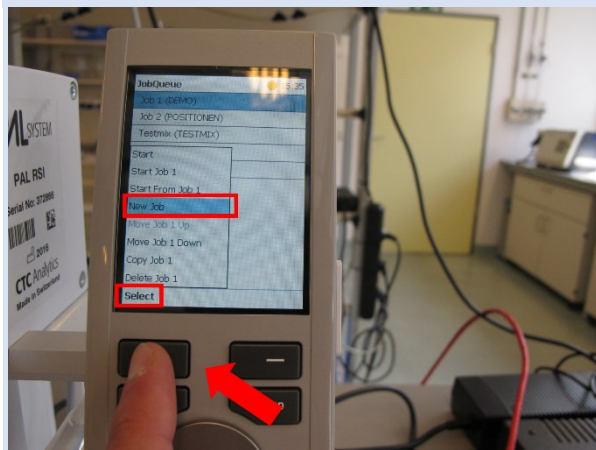

In **Options** menu select **New Job**.
With the **left function key** select **Select**.

6

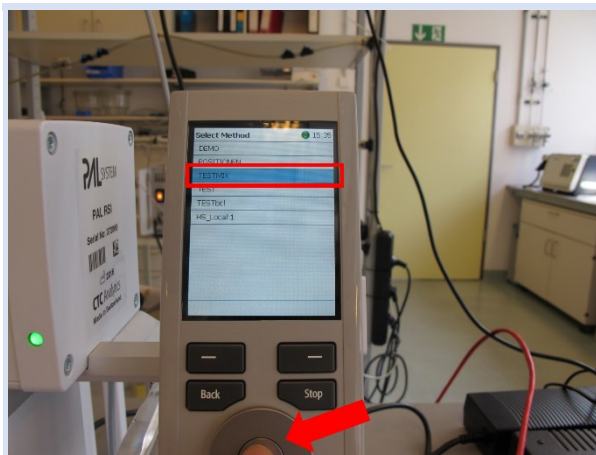

Move to the **method** and select it by pressing the **rotary knob**.

7

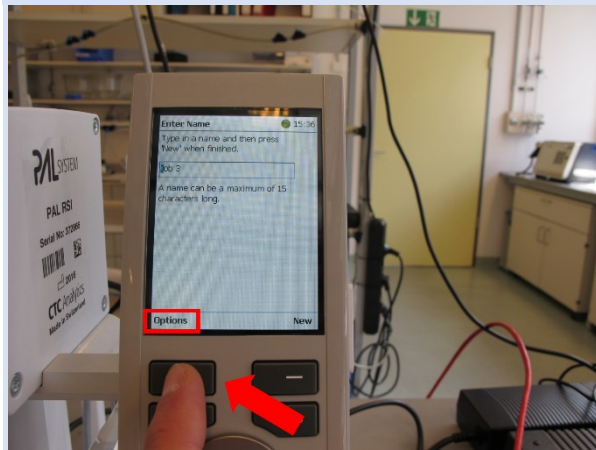

With the **left function key** select **Options**.

8

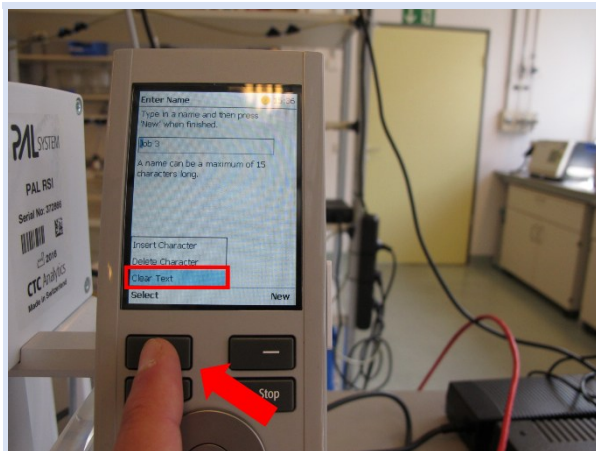

In **Options** menu select **Clear Text**.

With the **left function key** select **Select**.

9

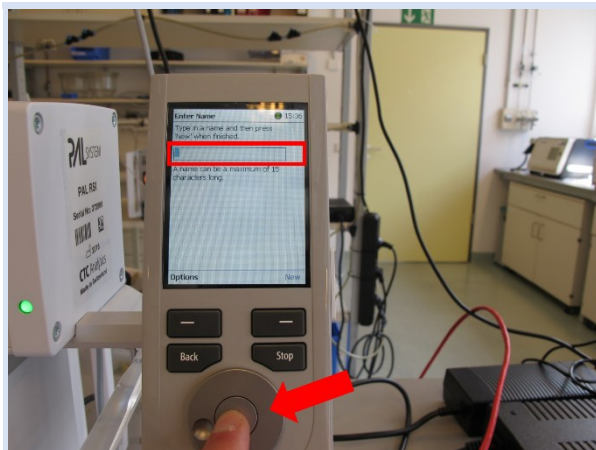

Press the **rotary knob** to edit the name.

10

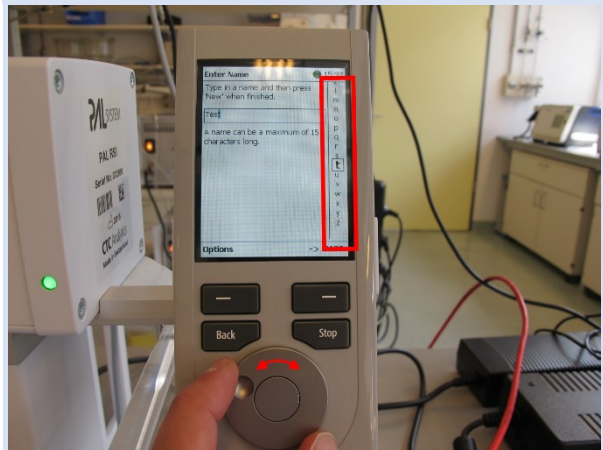

Select **letters and numbers** with the **rotary knob**.

11

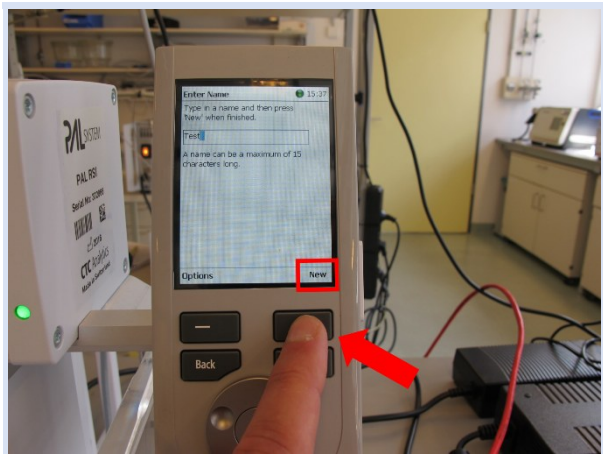

With the **right function key** select **New** to accept the new name and leave the screen.

12

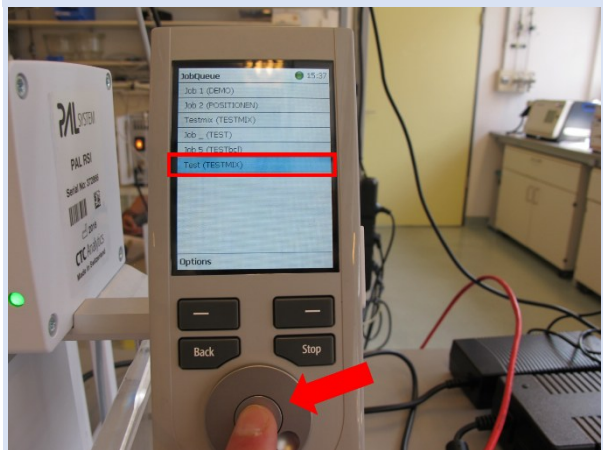

Select the new job and press the **rotary knob** to edit the job.

13

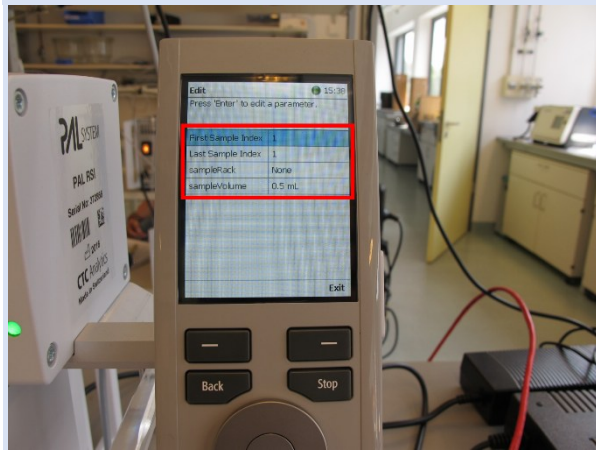

In job screen several parameters can be edit (see chapter 9.12).

14



Example:
Sample 1 to 21 should be measured. The position of the sample vials are 1 to 21 in the Tray. The Injection volume should be 300 µL.

15

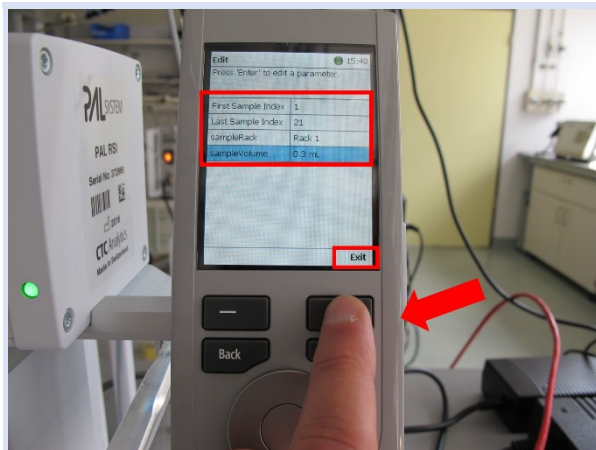

The following values must be entered:
First Sample Index: 1
Last Sample Index: 21
Sample Rack: Rack 1
Sample Volume: 0.3 mL

8.12 Edit a Job



INFORMATION!
A job contains the amount, the position of the sample vials in the tray and the sample volume that will be injected. A Job is always connected to a method (see chapter 8.4 and chapter 8.13).

1

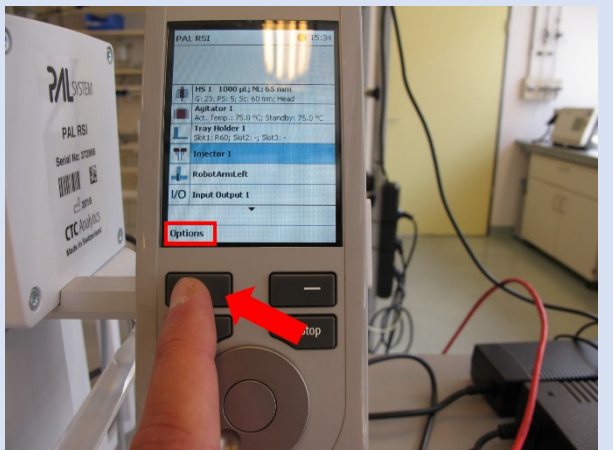

With the **left function key** select **Options**.

2

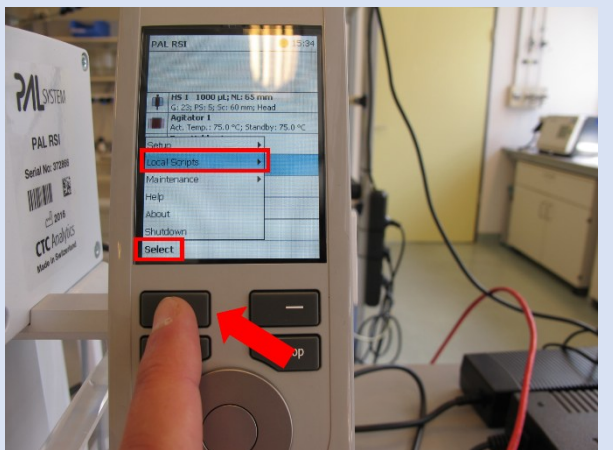

In **Options** menu select **Local Scripts**.
With the **left function key** select **Select**.

3

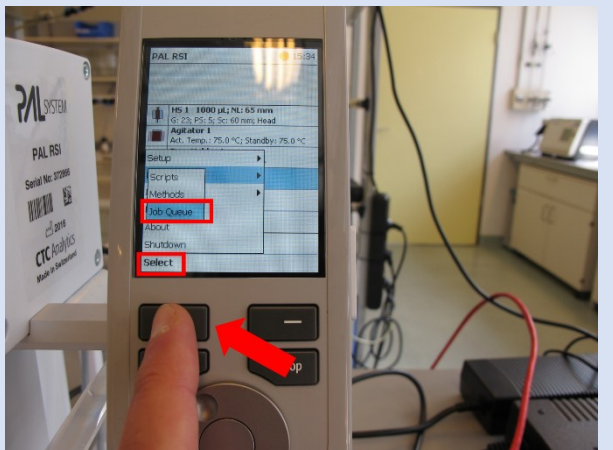

In **Options** menu select **Job Queue**.
With the **left function key** select **Select**.

4

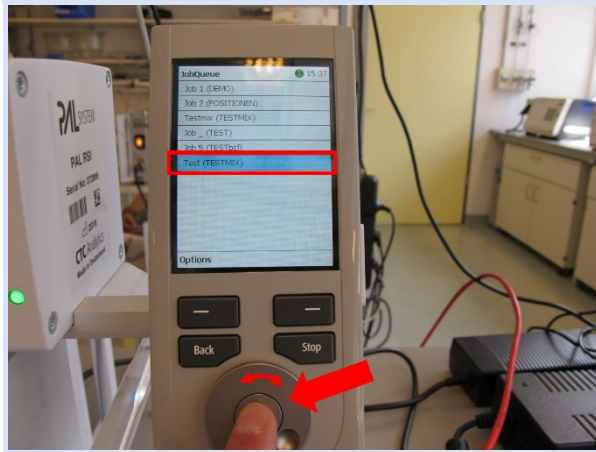

Move to the **job** and select it by pressing the **rotary knob**.

5

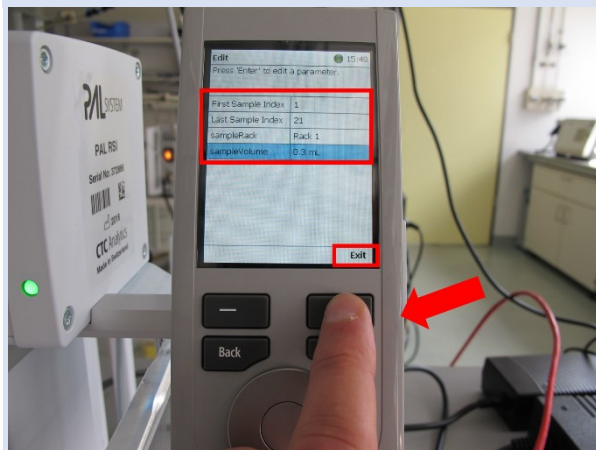

In job screen several parameters can be edit (see chapter 9.12).

6



Select the **Back** button to go to the main screen.

8.13 Create a New Method



INFORMATION!
A method contains incubation time and -temperature, the analyte time ... (see chapter 9.10 and 9.11). A method is required for a job.

1

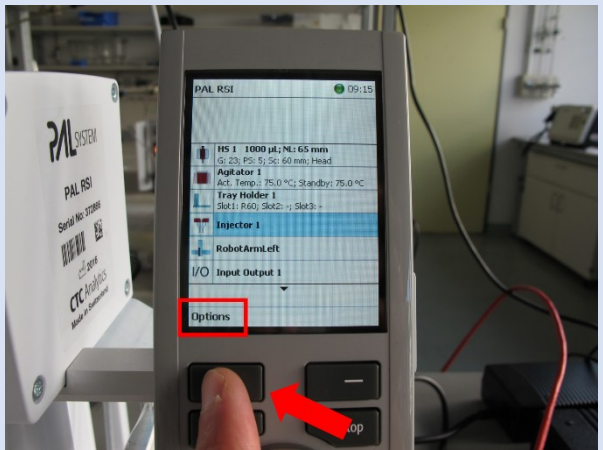

With the **left function key** select **Options**.

2

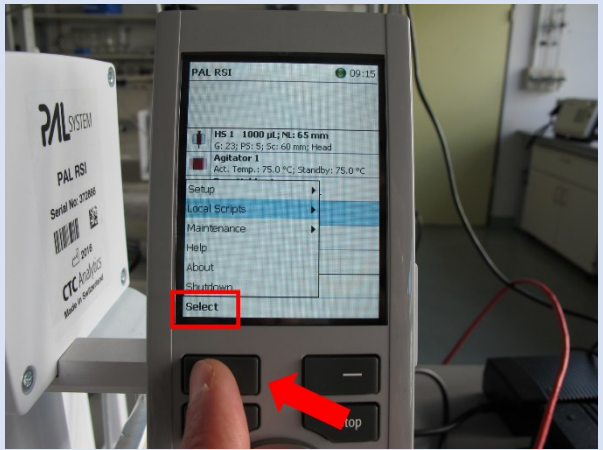

In **Options** menu select **Local Scripts**.
With the **left function key** select **Select**.

3

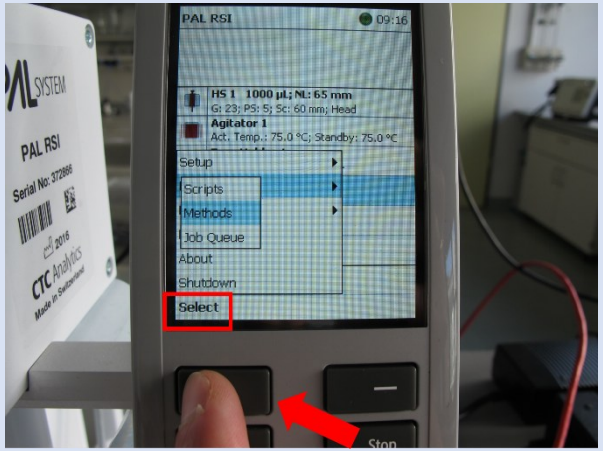

In **Options** menu select **Methods**.
With the **left function key** select **Select**.

4

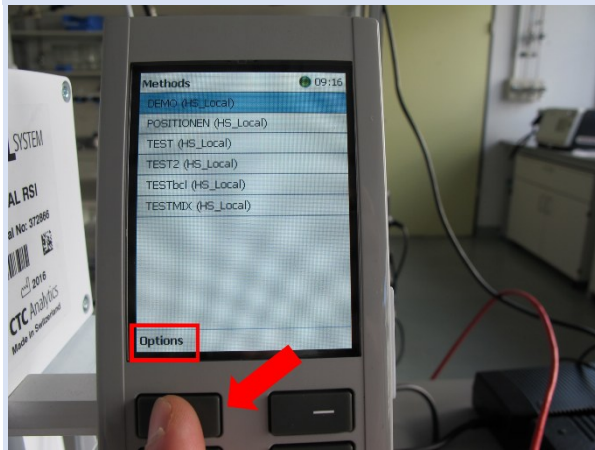

With the **left function key** select **Options**.

5

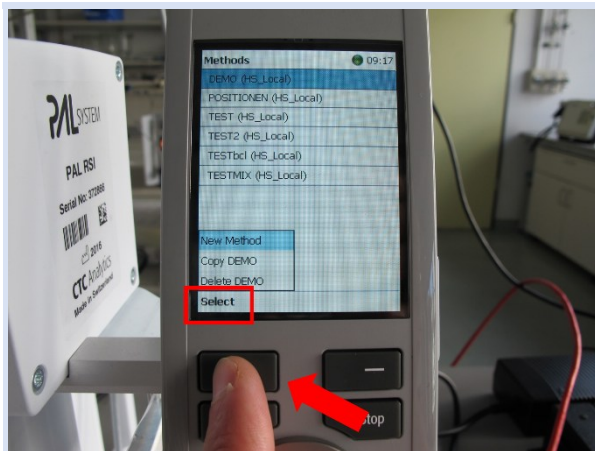

In **Options** menu select **New Method**.
With the **left function key** select **Select**.

6

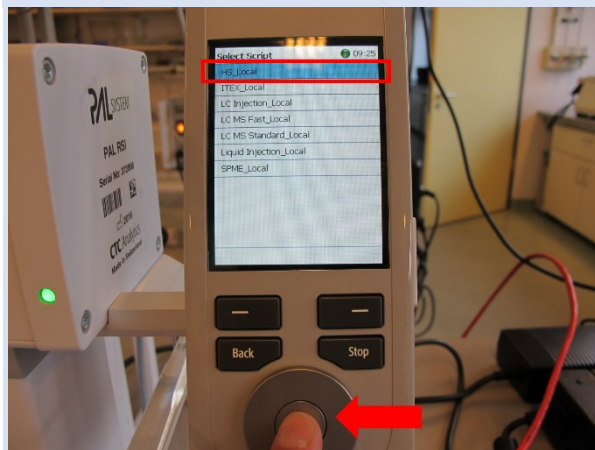

Select the script **HS_Local**.



INFORMATION!

The intended use of the FlavourSpec® is only headspace measurement. Only the script **HS_Local** will work.

7

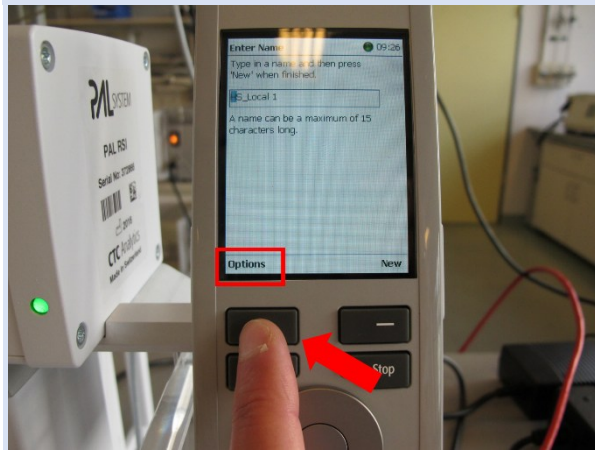

With the **left function key** select **Options**.

8

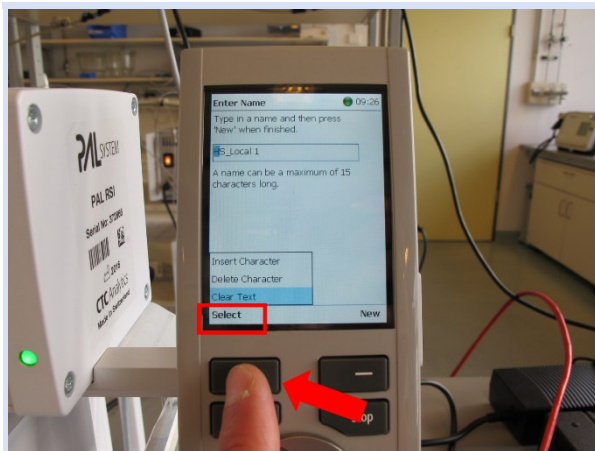

In **Options** menu select **Clear Text**.
With the **left function key** select **Select**.

9

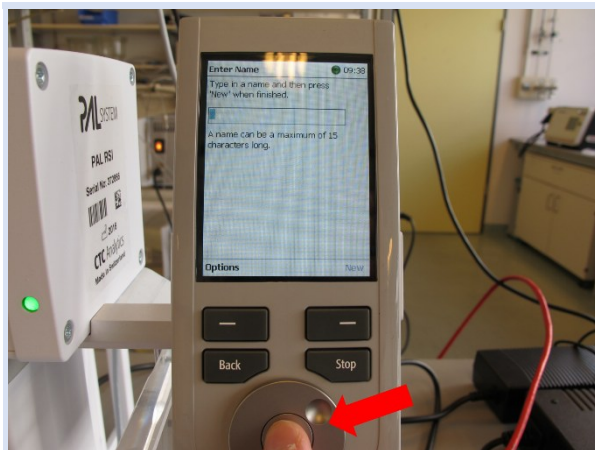

Press the **rotary knob** to enter a new name.

10

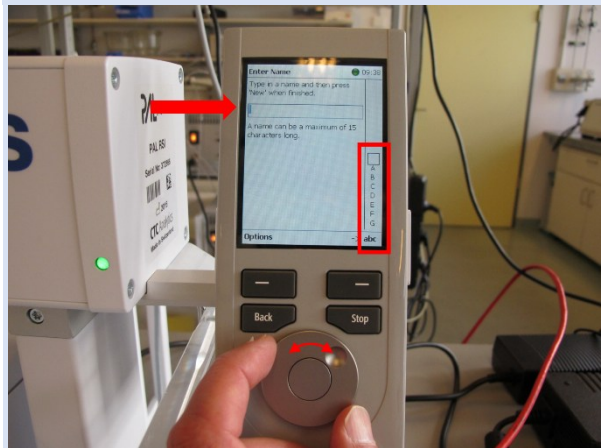

Select **letters and numbers** with the **rotary knob**.

11

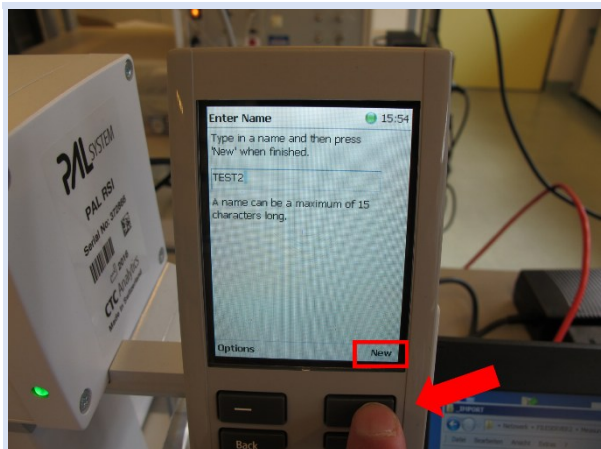

With the **right function key** select **New** to accept the new name and leave the screen.

12

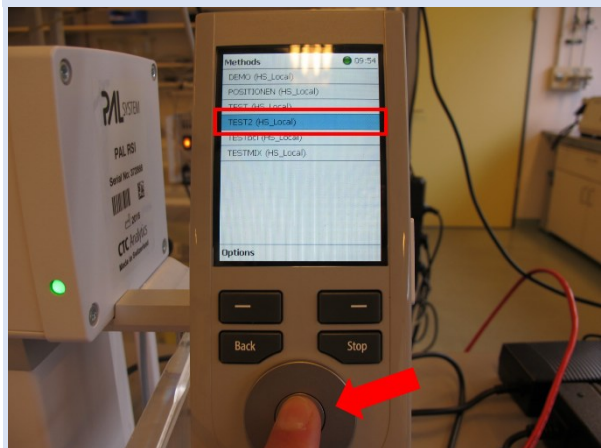

Select the new method and press the **rotary knob** to edit the method.

13

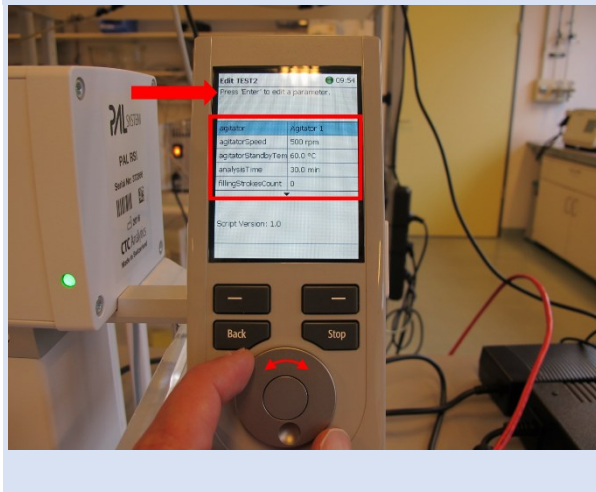

In method screen several parameters can be edit (see chapter 9.10 and 9.11).

8.14 Edit a Method



INFORMATION!

A method contains Incubation time and -temperature, the analyte time ... (see chapter 9.10 and 9.11). A method is required for a job.

1

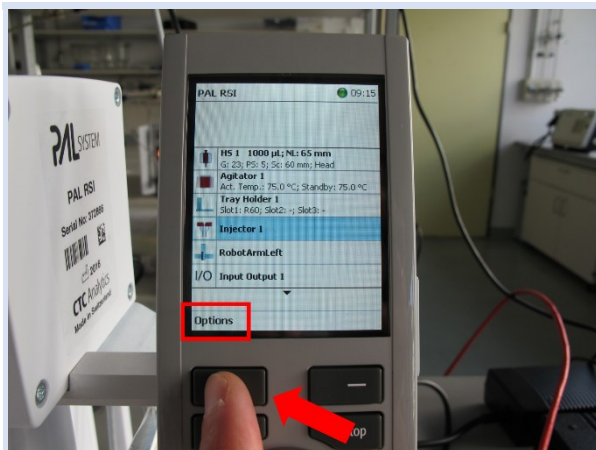

With the left function key select Options.

2

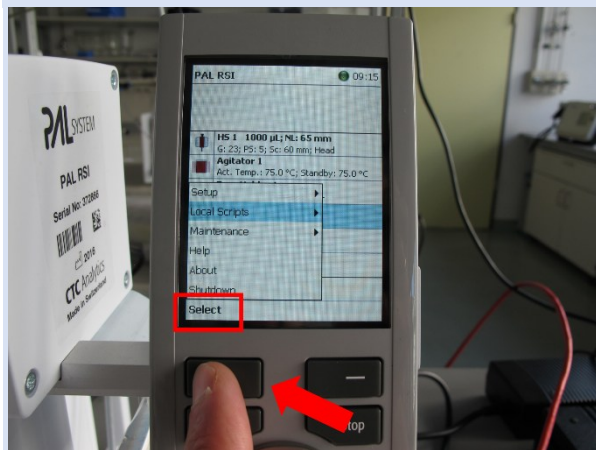

In Options menu select Local Scripts. With the left function key select Select.

3

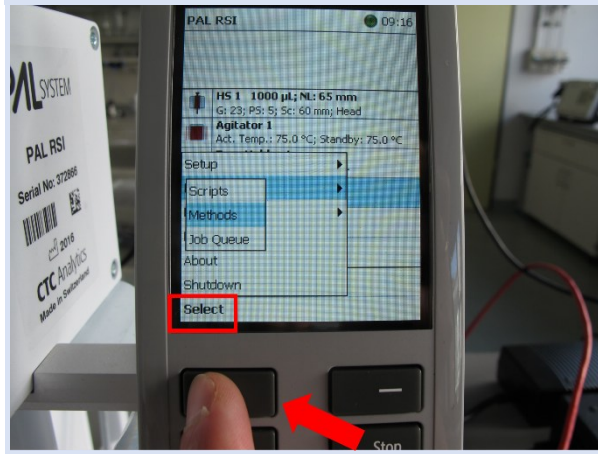

In **Options** menu select **Methods**.
With the **left function key** select **Select**.

4

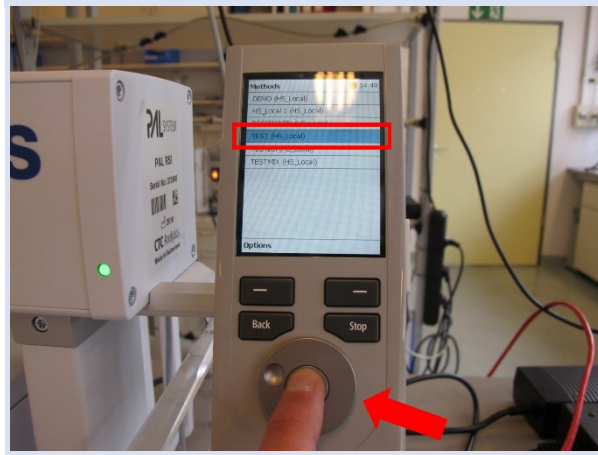

Select the **new method** and press the **rotary knob** to edit the method.

5

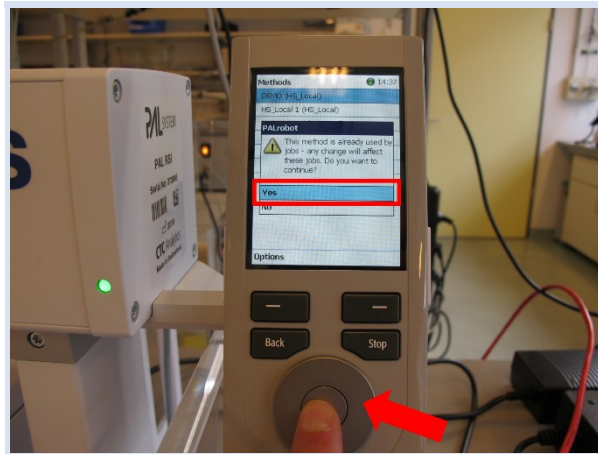

In the Information windows select **YES**.

6

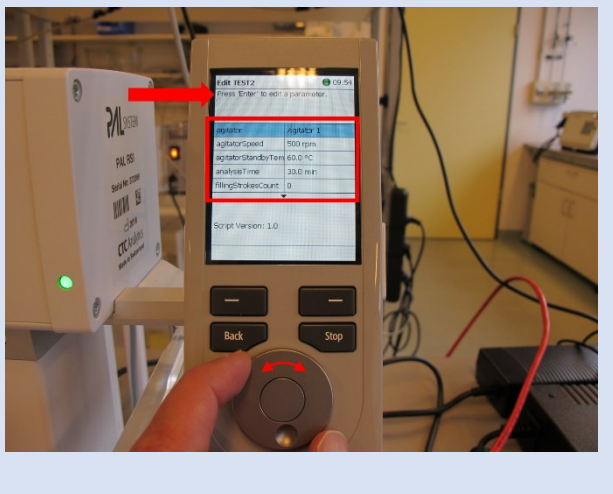

In method screen several parameters can be edit (see chapter 9.10 and 9.11).

8.15 Run a measurement with autosampler



INFORMATION!
To run measurements with an autosampler the following steps are required.

1

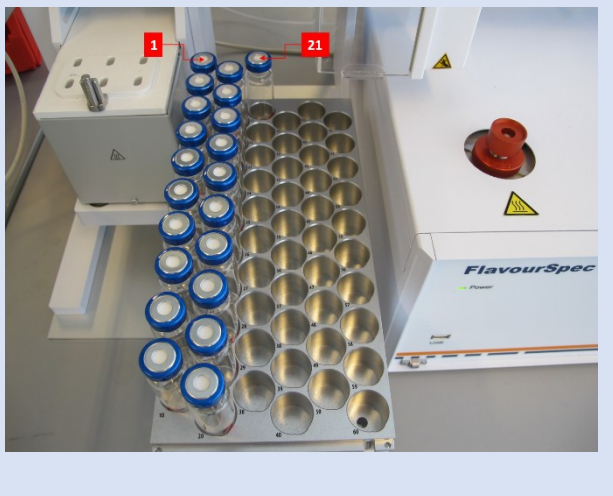

Put the sample into the tray.

2

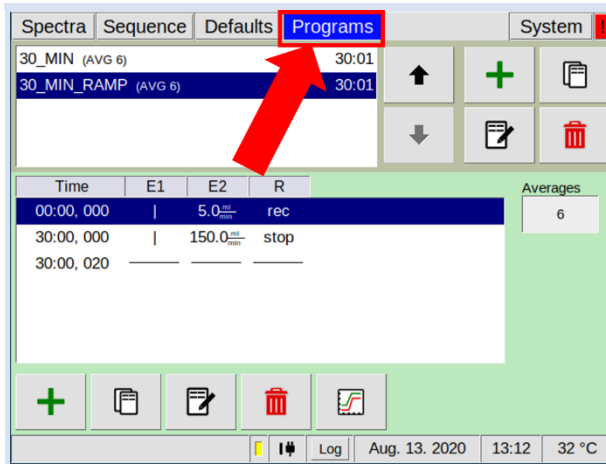

Create a measurement program (see chapter 6.5.2) or select one (see chapter 8.3).

The start values for **E_IMS** and **E_GC** must correspond...

3

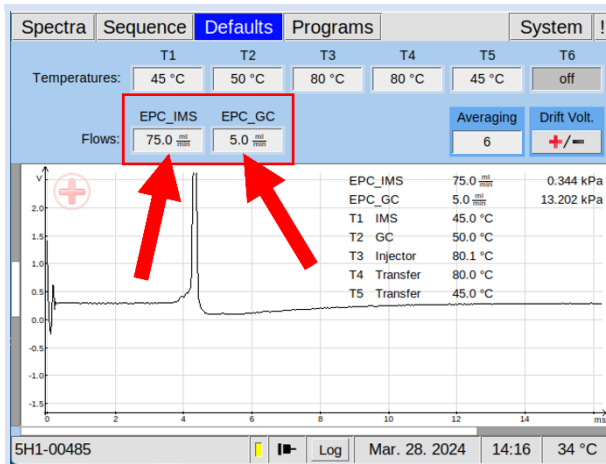

...to the values for **EPC_IMS** and **EPC_GC** in Defaults window.

4

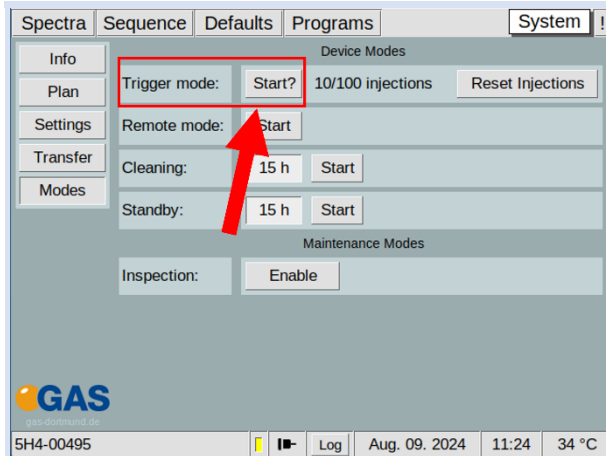

In Sytem window select **Trigger mode**.

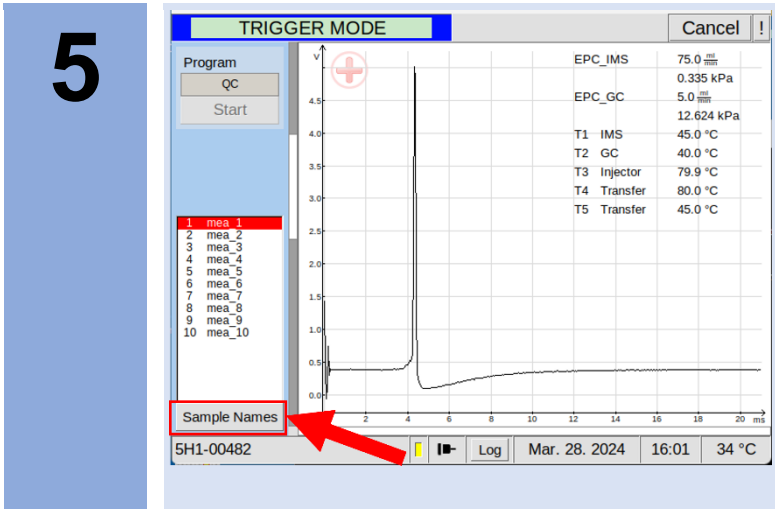

In Trigger Mode select **Sample Names**.

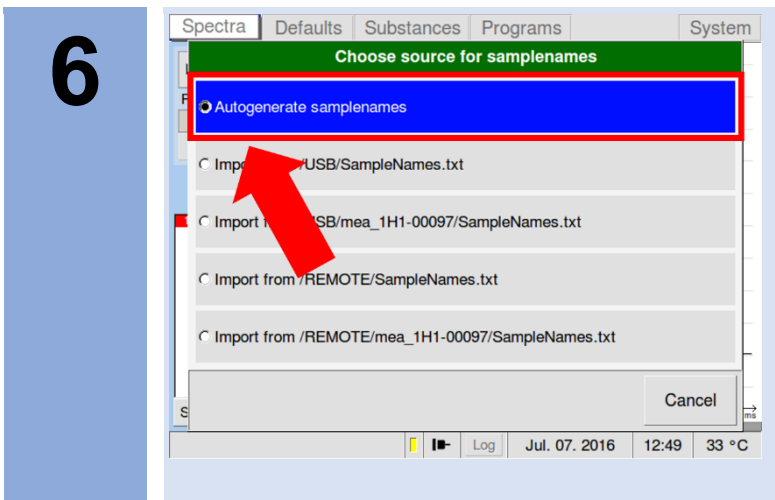

To generate an automatic sample list select **Autogenerate samplenames**.

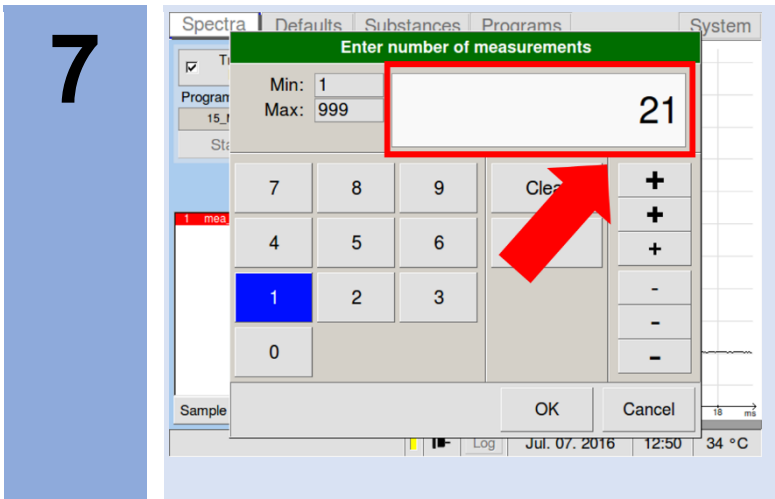

Enter the number of samples.

8

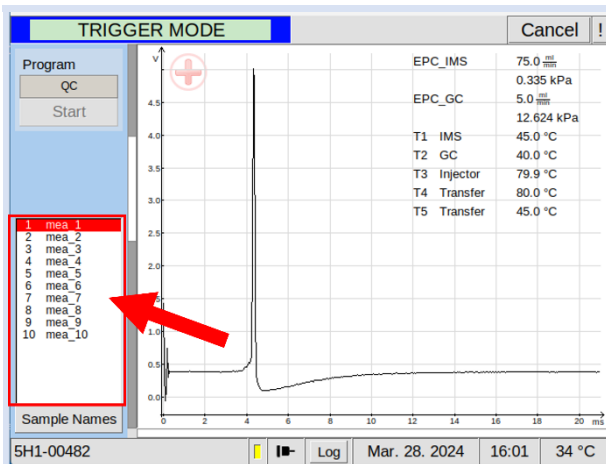

The current sample list is shown.

9

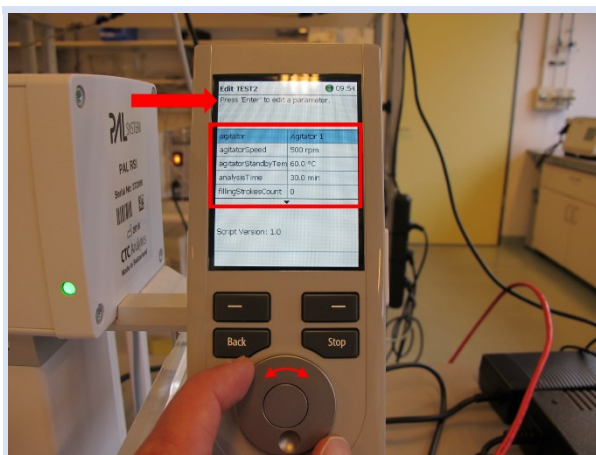

Create a new method (see chapter 8.13) or edit a method (see chapter 8.14).

10

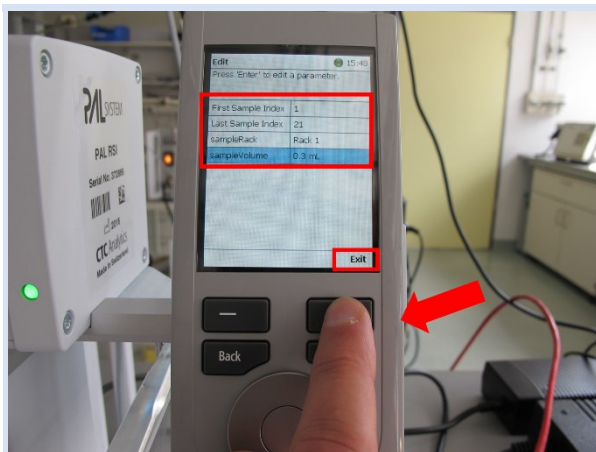

Create a new job (see chapter 8.11) or edit a job (see chapter 8.12).

Enter the number of samples.

11

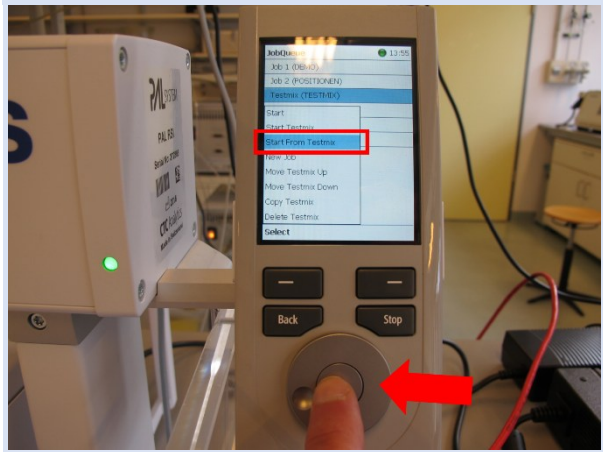

Select the job and start with **Start From 'Job'**.

12

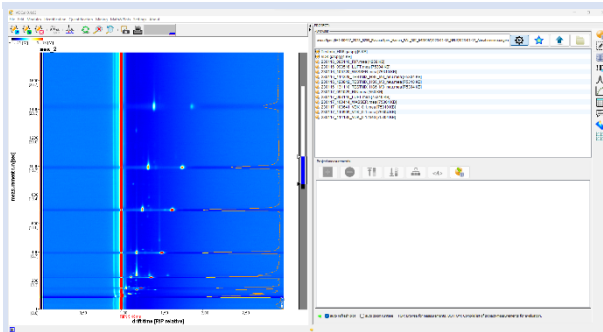

View and analyse the measurement files with the VOCal software.

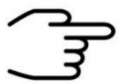

INFORMATION!

For detailed information about the VOCal software refer to the VOCal Software Manuals and Tutorials.

8.16 Run a measurement with manual injection



INFORMATION!

Measurements can also be carried without an autosampler. The headspace sample must be injected manually and the device must also be started manually.

1

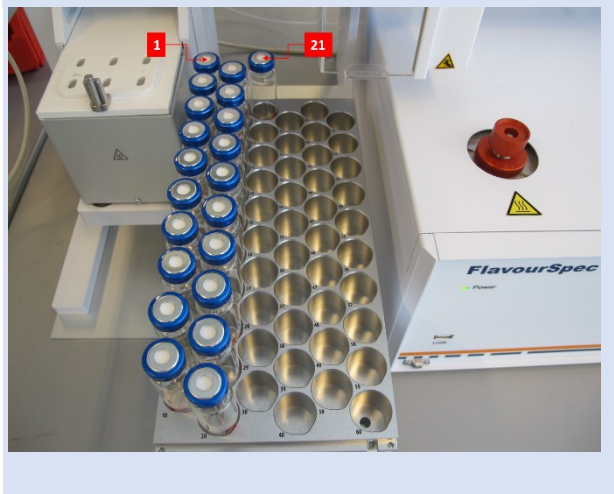

Put the sample into the tray.

2

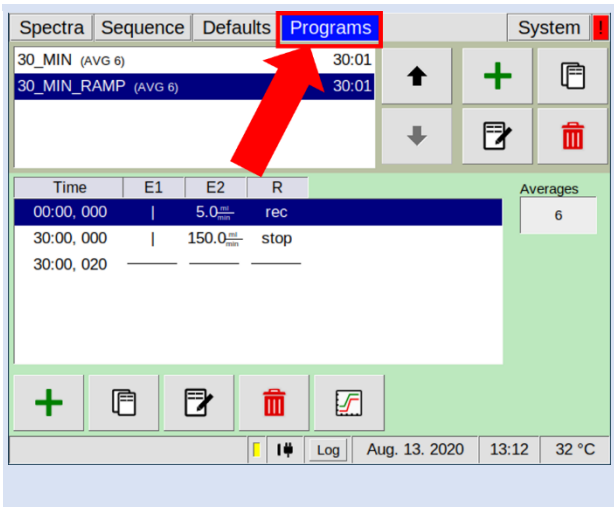

Create a measurement program (see chapter 6.5.2) or select one (see chapter 8.11). The start values for **E_IMS** and **E_GC** must correspond...

3

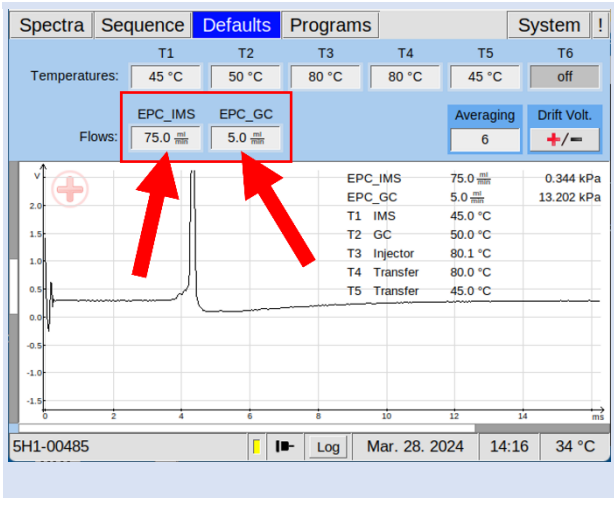

...to the values for **EPC_IMS** and **EPC_GC** in Defaults window.

4

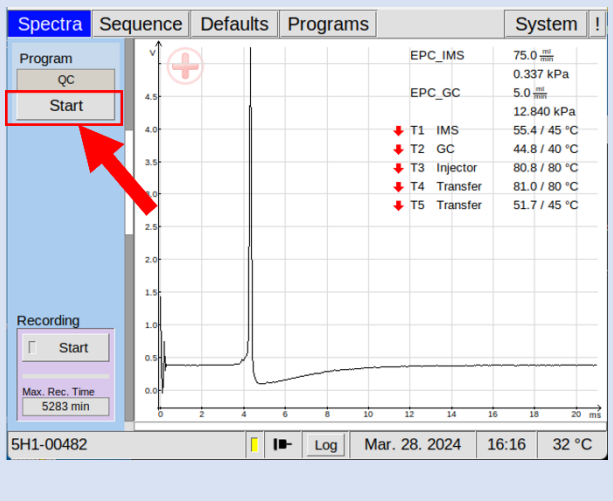

In Spectra window select **Start**.

5

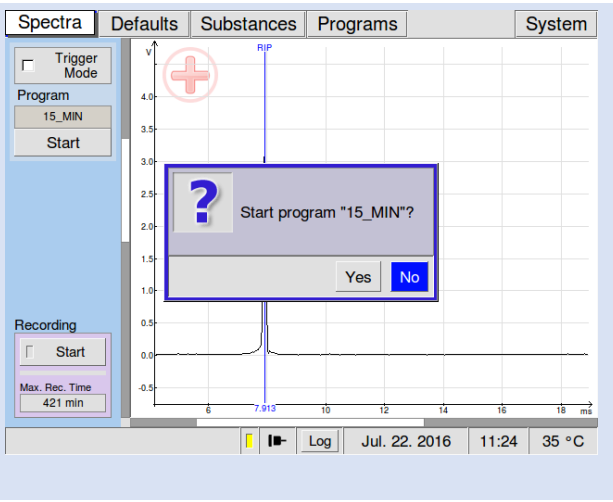

An information windows appears.

6

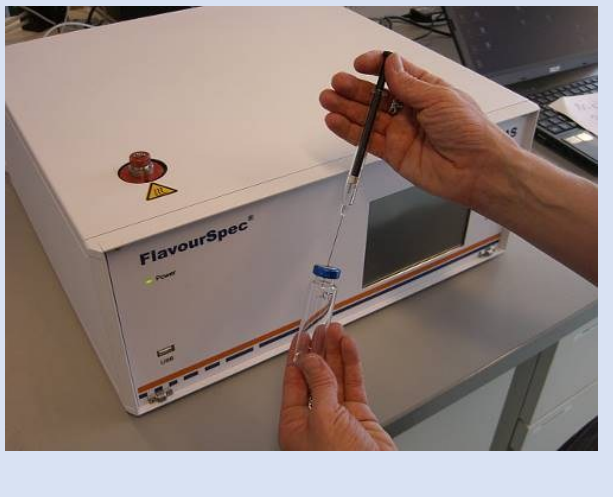

Collect the headspace sample with a proper gastight syringe.

7

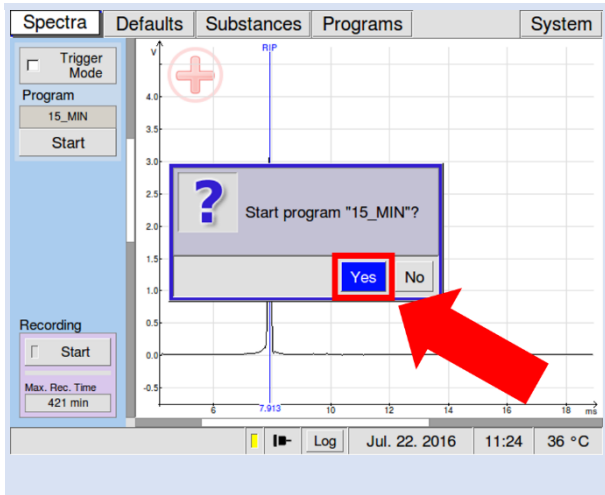

Select **YES** in the information window.

8

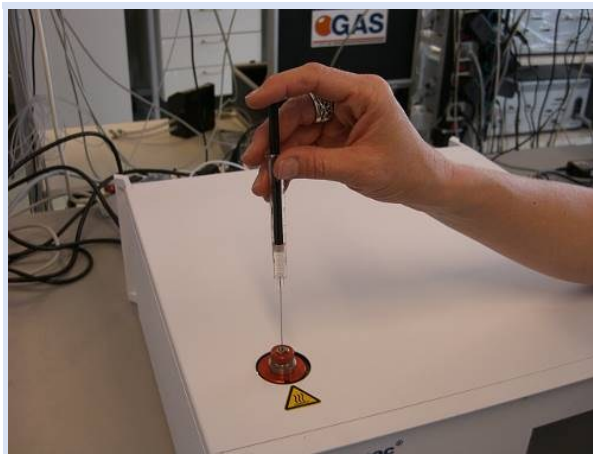

Inject the headspace sample into the sample injector port.

12

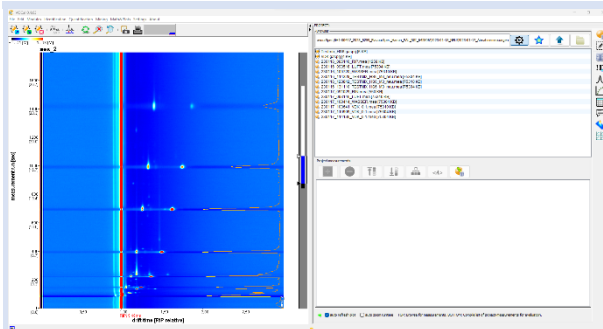

View and analyze the measurement files with the VOCal software.



INFORMATION!

For detailed information about the VOCal software refer to the VOCal Software Manuals and Tutorials.

8.17 Setting the injection counter



INFORMATION!

The septum can be permanently perforated by injections, which can lead to leaks in the system. Regular replacement of the septum is therefore recommended. As a rule, modern septa last for 100 injections or more. Factors that affect septum life are syringe size, inlet temperature, etc.

The user can set the maximum number of injections at which a warning is issued. The default value is set to 100. The maximum number is 500 injections.

1

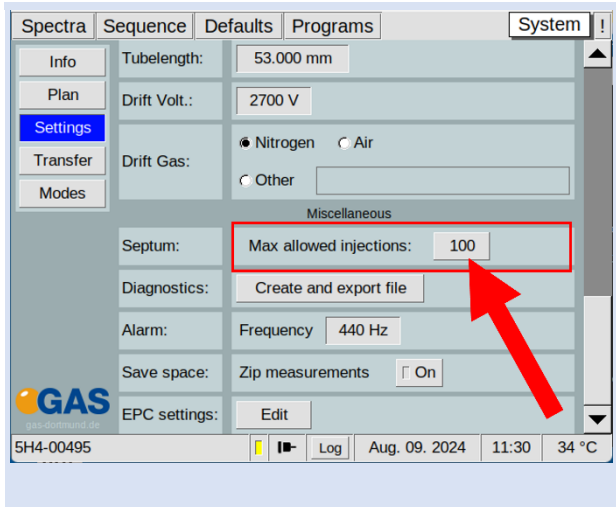

In system window go to **Settings** and select Max. allowed injections to set the user-specific number of injections.

2

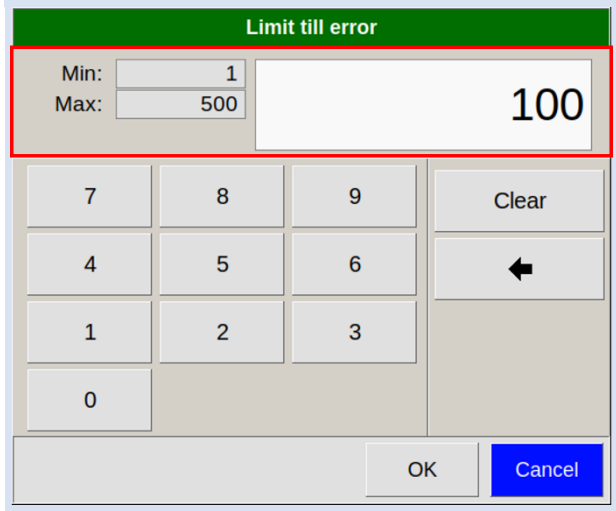

Permitted values are between 1 and 500. The default value is 100.

3

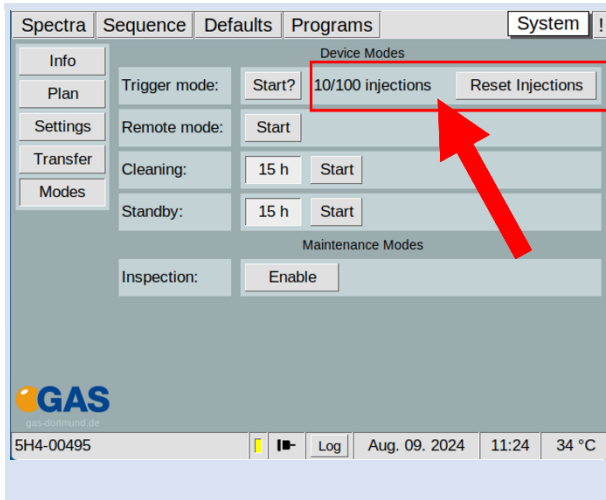

The current number of injections is displayed in the system window under **Modes**. It can also be reset here.

4

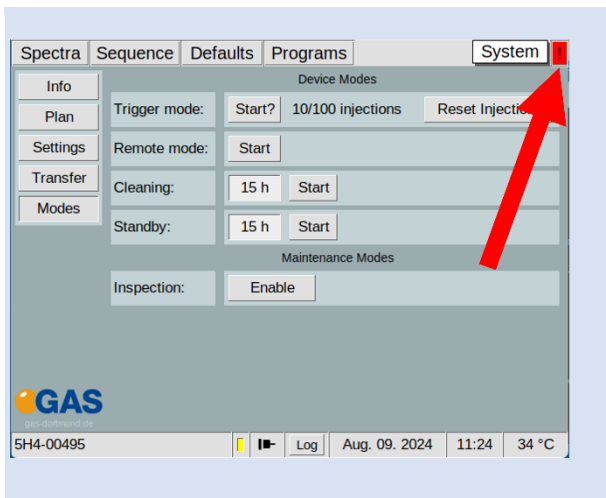

If the maximum number of injections is exceeded, the **!-Tab** flashes red and the message **Maximum durability has been reached** is logged.

8.18 Change Septum



INFORMATION!

Typically modern septa can last 100 injections or more. Factors that affect the septa lifetime are syringe size, inlet temperature etc.



WARNING!

The Injector can become very hot. Risk of burning. Use heat-resistant gloves.

1

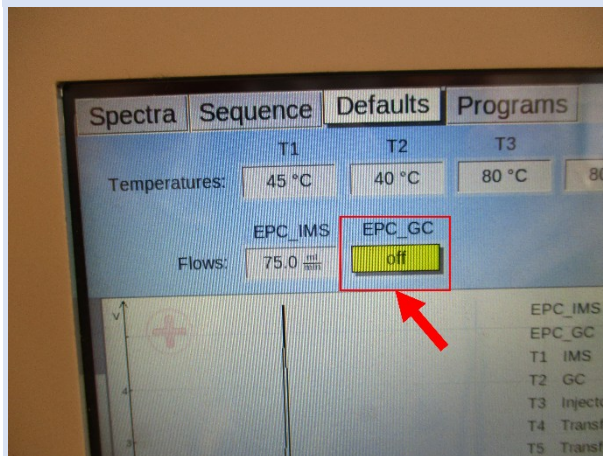

Set **off** the carrier gas flow (**EPC_GC = off**).

2



Unscrew the injector adapter with septum retainer nut.

3

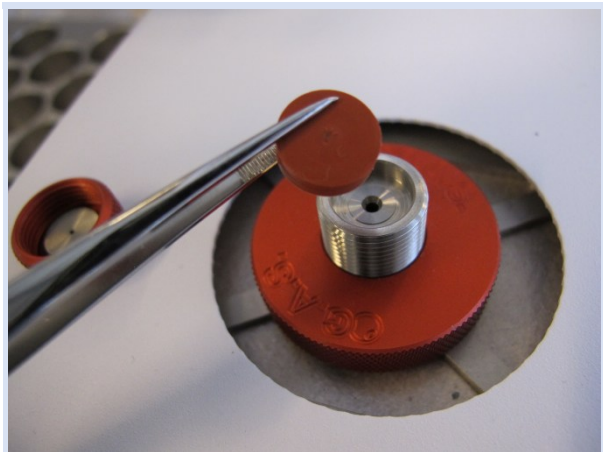

Remove the old septum, insert a new septum. (11-mm Septs, high temperature, low-bleed).

4

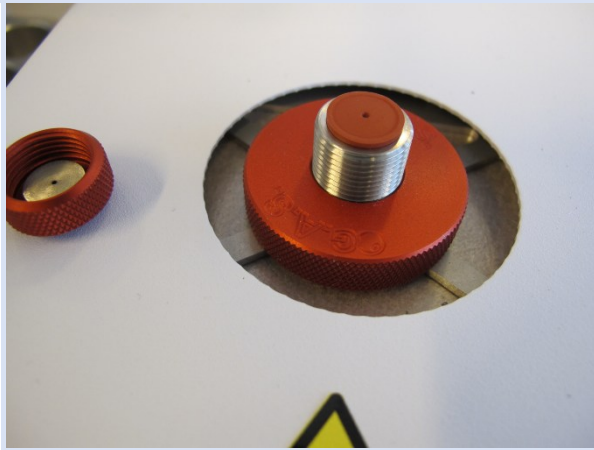

Press the septum into the injector.

5



Screw the injector adapter with septum retainer nut shut by hand.

6

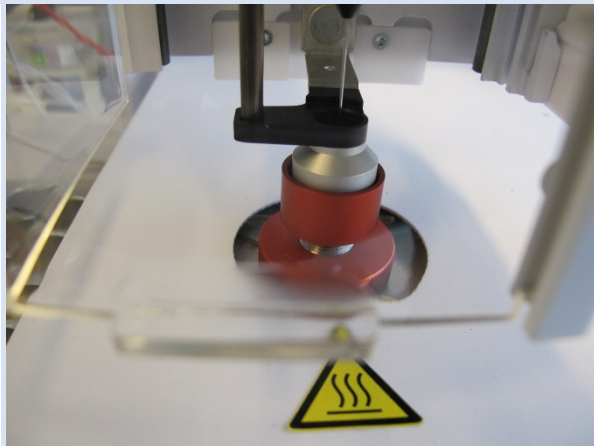

Check the Injector position (see chapter 8.2).

8.19 Change syringe

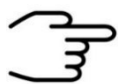

INFORMATION!

The FlavourSpec® in combination with the autosampler PAL RSI, is delivered with a gastight 1 mL syringe. To change a syringe do the following:

8.19.1 Disabling the Syringe tool

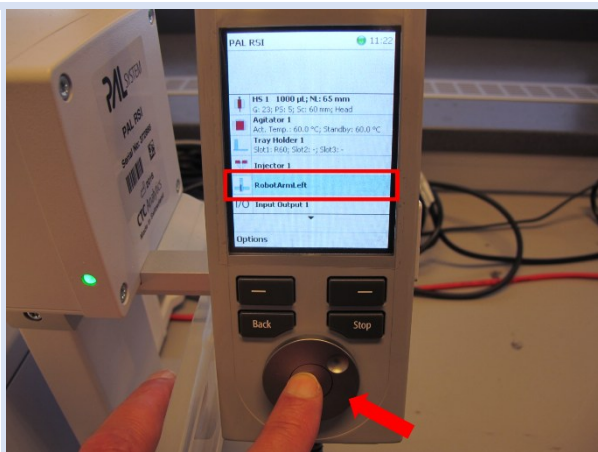
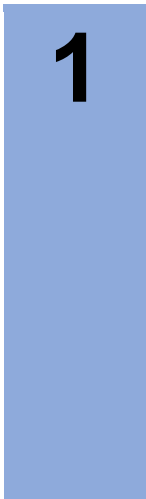

On the PAL RSI main screen select **RobotArmLeft**.

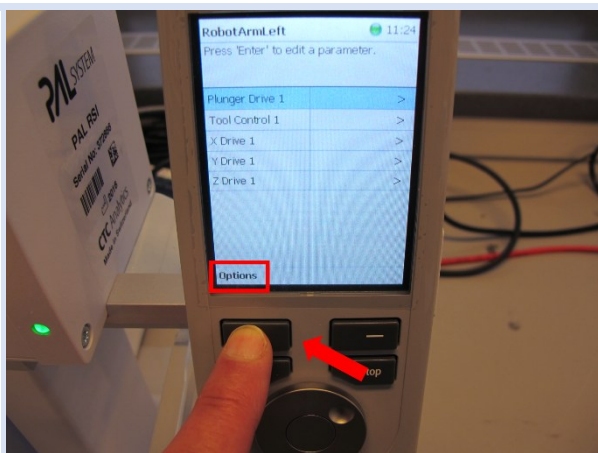
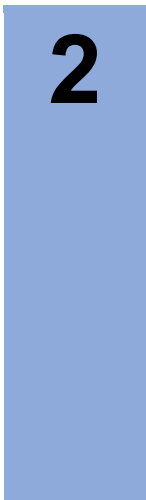

With the **left function key** select **Options**.

3

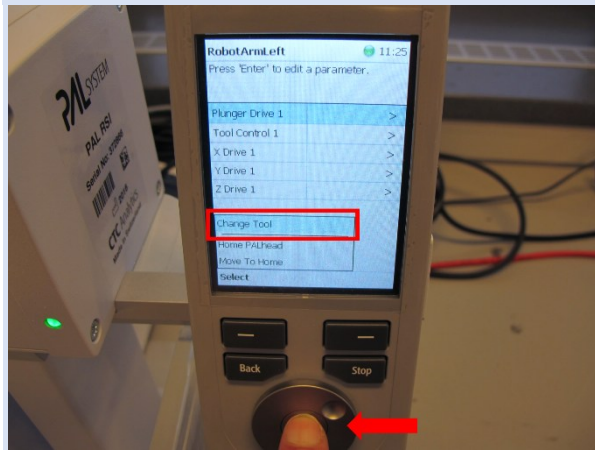

In **Options** menu select **Change Tool**.

4

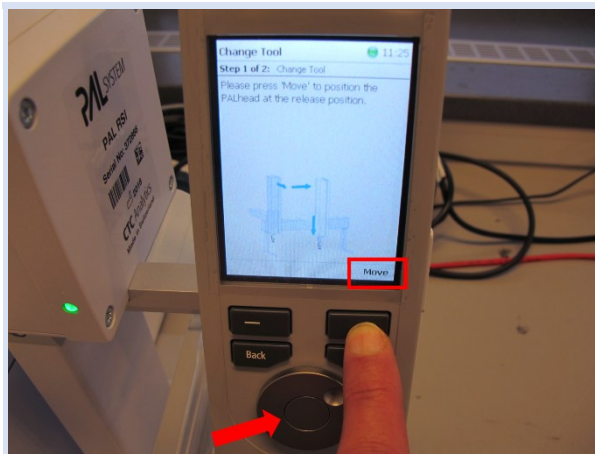

With the **right function key** select **Move**.

5

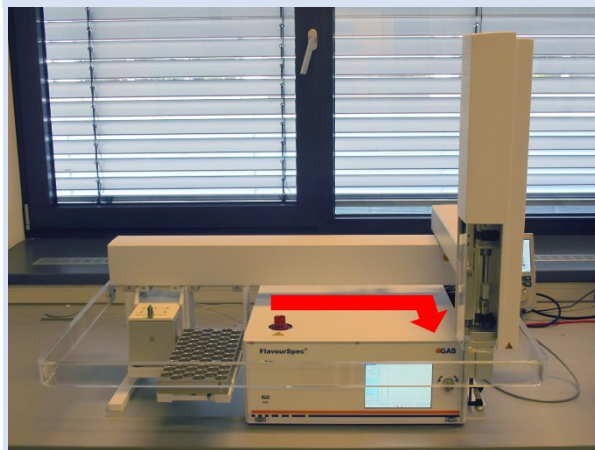

After a **warning signal** the **arm moves** to the actual change tool position.

6

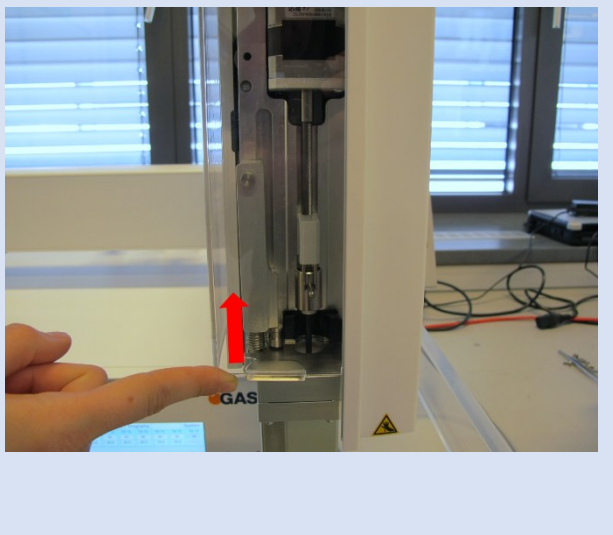

Move the protective cover to its upper position.

7

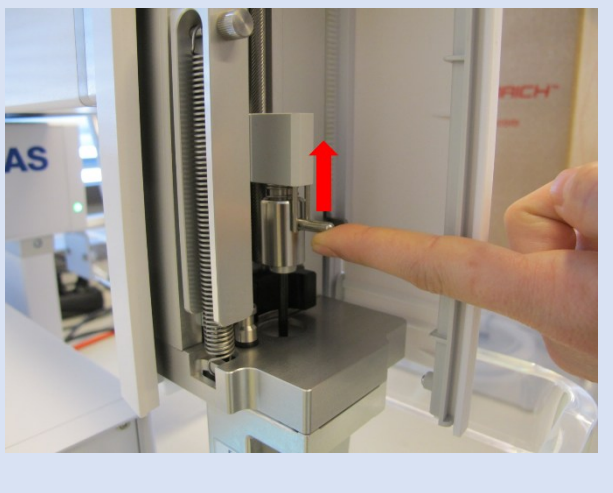

Move the holder upwards.

8

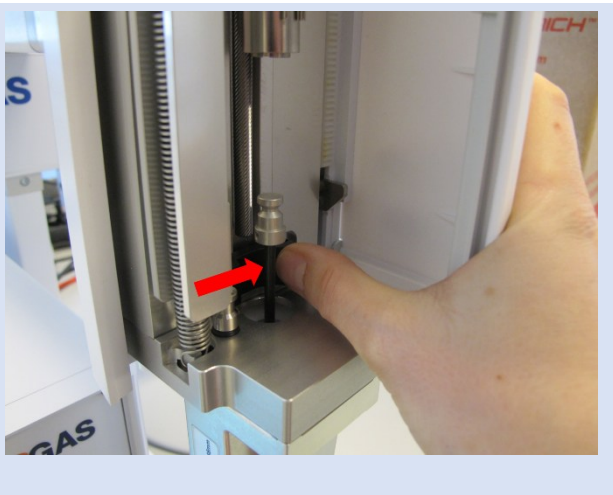

Push the locking...

9

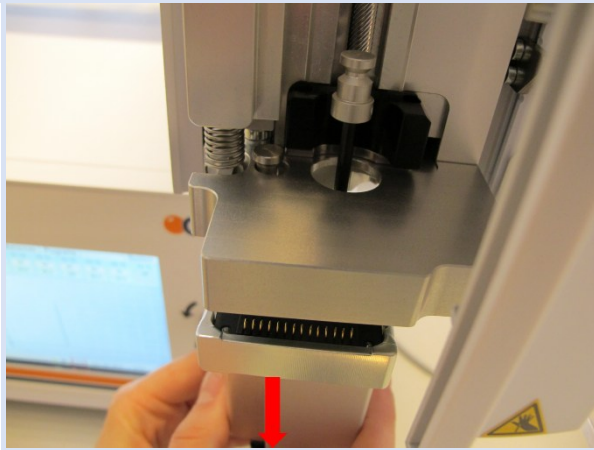

...and remove the syringe tool.

10

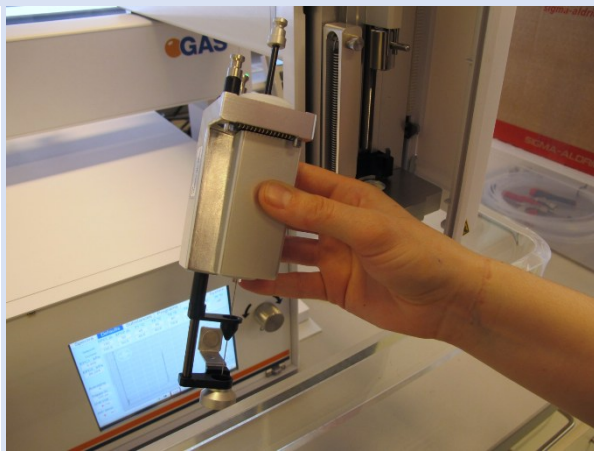

The figure shows the syringe tool.

8.19.2 Disassembling the Syringe

1

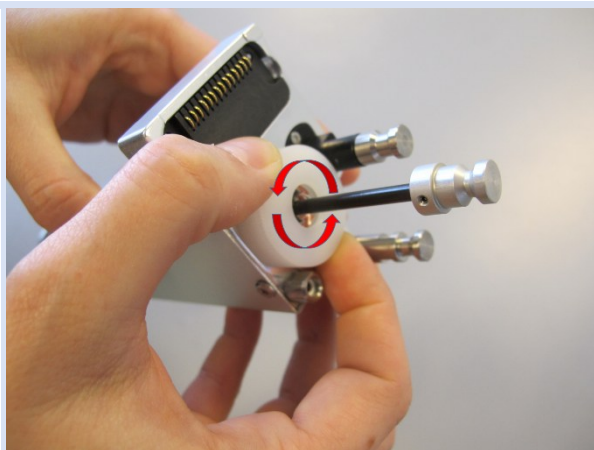

Unscrew the white plastic retainer.

2

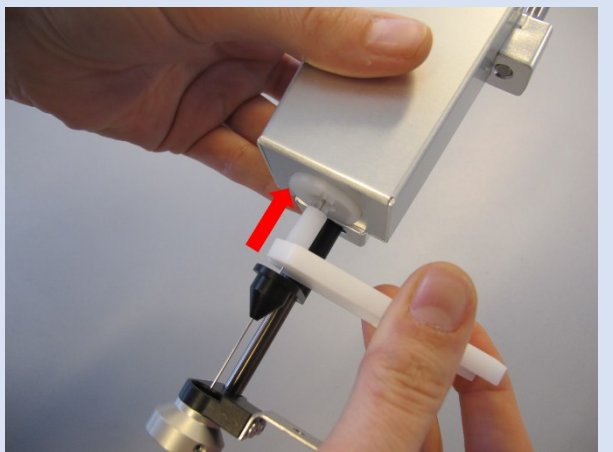

Use the syringe auxiliary tool to remove the syringe.

3

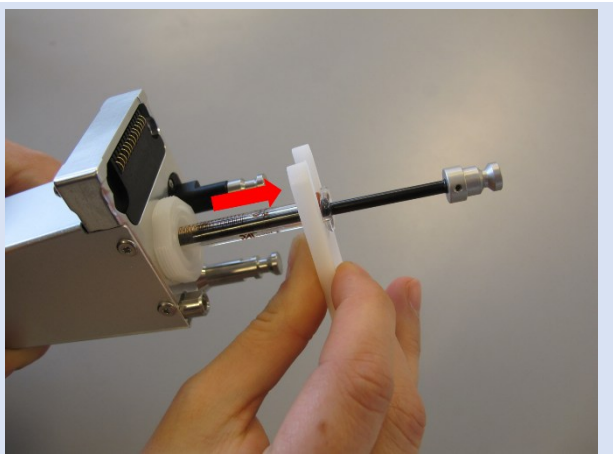

Use the syringe auxiliary tool to remove the syringe.

4

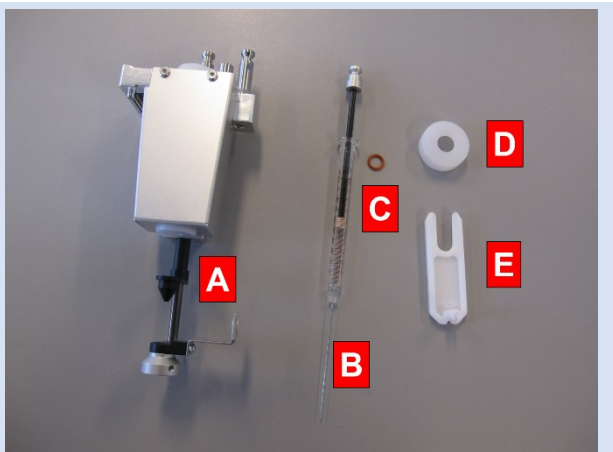

A: Syringe tool with heater
B: Syringe (gastight)
C: O-ring for syringe
D: Plastic retainer
E: Syringe auxiliary tool

8.19.3 Install a syringe



WARNING!

Be careful when installing a syringe, to avoid injuries.

1

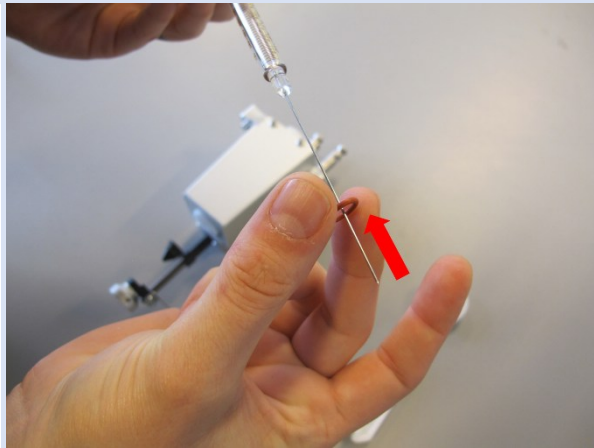

Install a new O-ring....

2

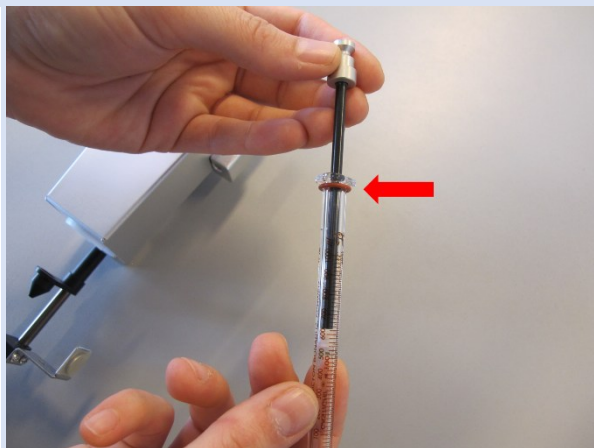

...install a new O-ring

3

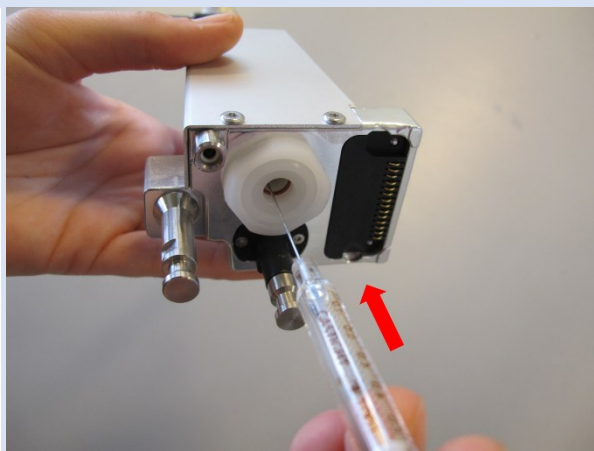

Install the syringe with O-ring into the syringe tool.

4

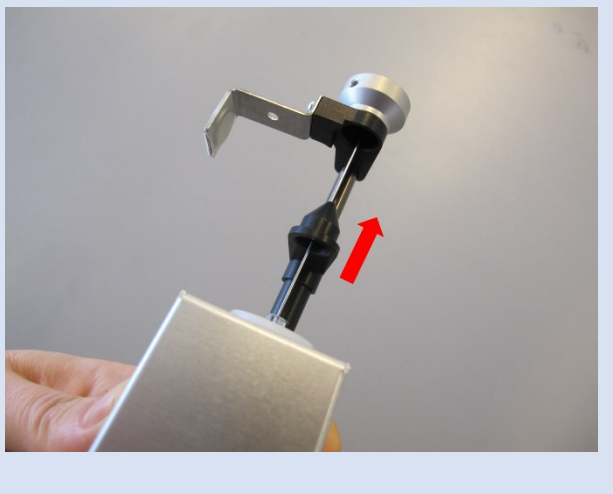

Pay attention to a proper needle guide.

5

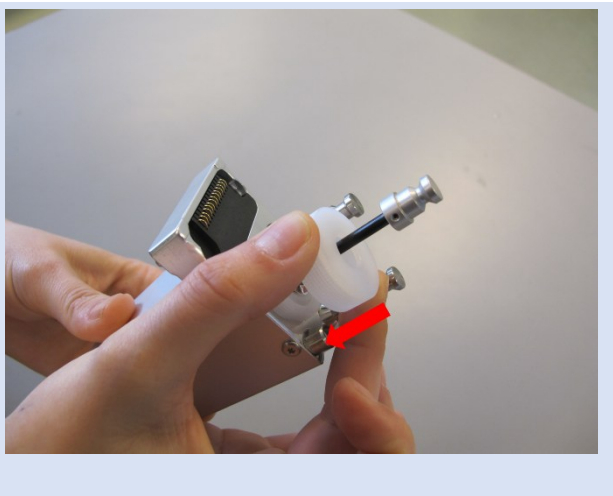

Put on the white plastic retainer and...

6

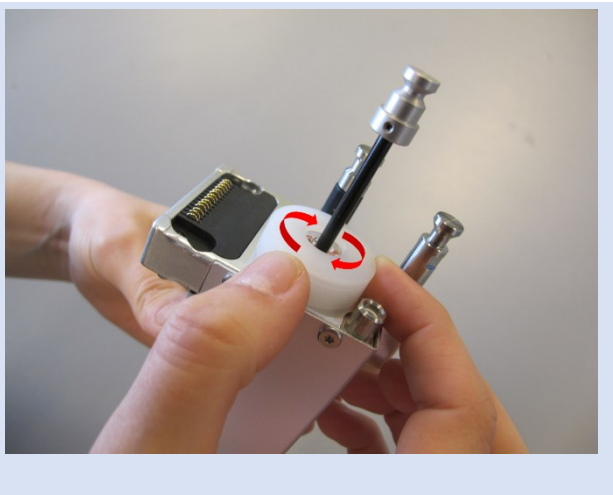

...fix the syringe.

8.19.4 Install the syringe tool

1

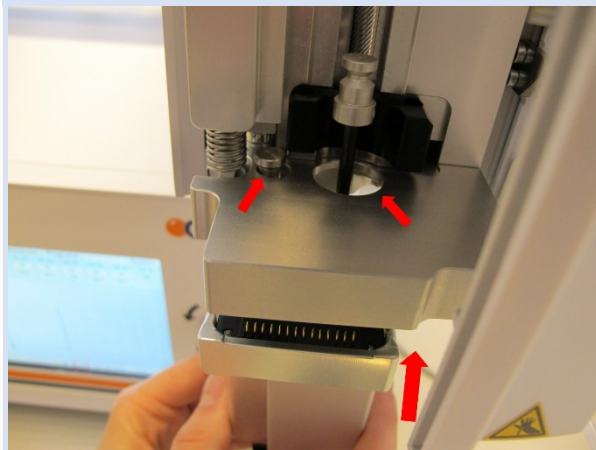

Place the syringe tool back into the holder.

2

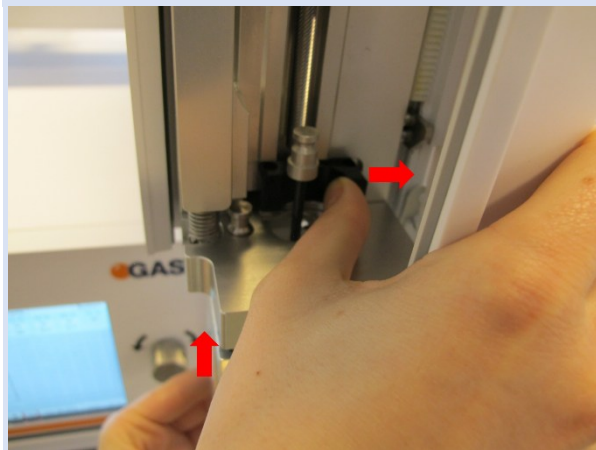

Push the locking and insert the tool and release the locking.

3

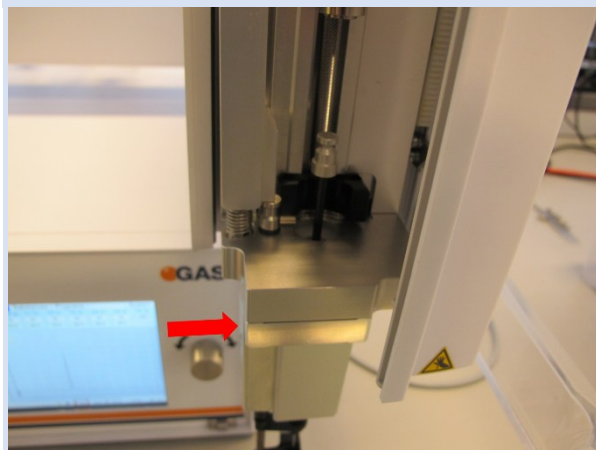

The figure shows the installed syringe tool.

4

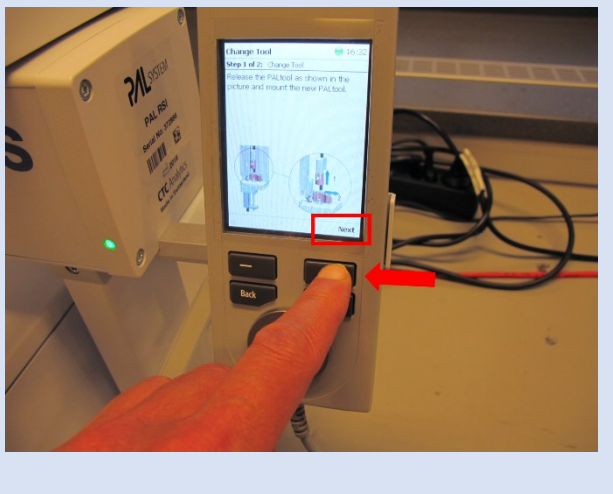

With the **right function key** select **Next**.

5



The syringe holder moves down...

6



...and after a **warning signal** the **arm moves** to the home position.

7

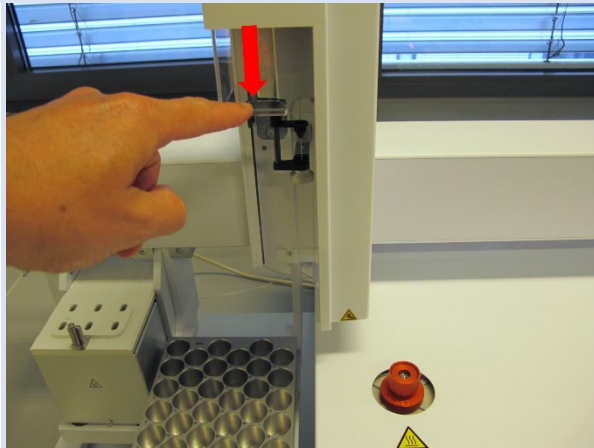

Move the protective cover to lower position.

8

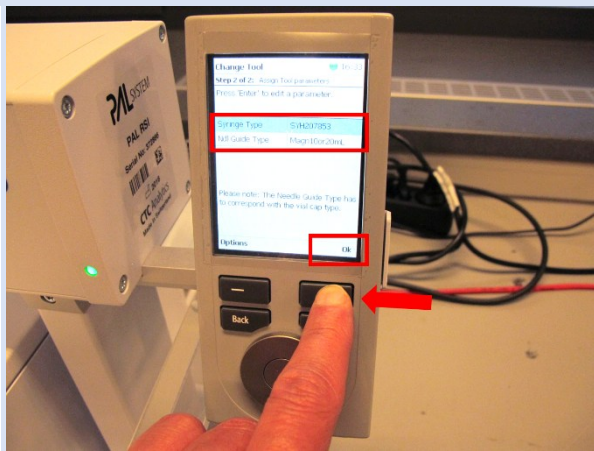

Check the syringe identification:

Syringe Type:
SH1000-65-T-23-SP
NdlGuideType:
Magn.10or20mL

With the **right function key** select **OK**.

9



Select the **Back** button to go to the main screen.

8.20 Creating and Copying a PAL3 RSI Backup file



INFORMATION!

The 'Create backup' option is used to create a backup file of the PALrobot in its current state. This backup file is saved on the internal memory of the PALcontrol board. Only one backup file can be stored on the internal memory of the PALcontrol board at a time. If more than one backup file is to be stored, it can be copied to a USB stick using the 'Copy backup' function.

1

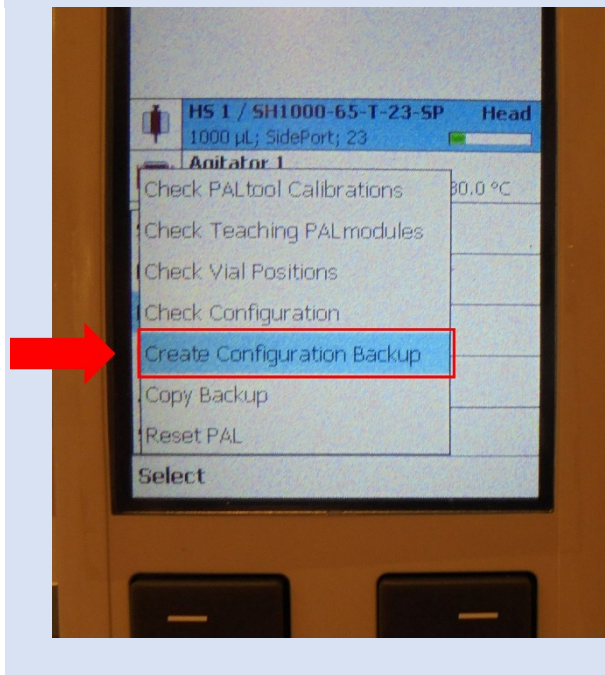

Path (in User mode or Extended User mode):
Main screen → Options → Maintenance → **Create Configuration Backup**

2

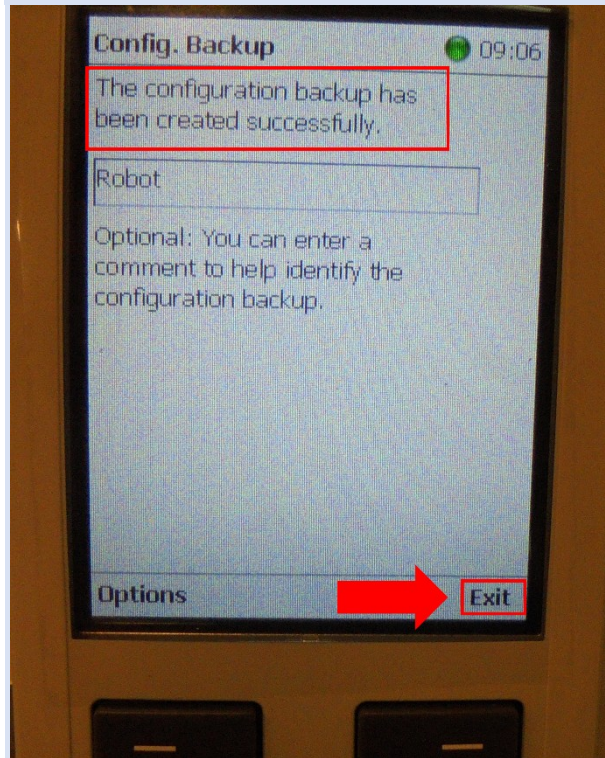

The backup file is stored on the internal memory on the PALcontrol board.

Select **Exit**.

3

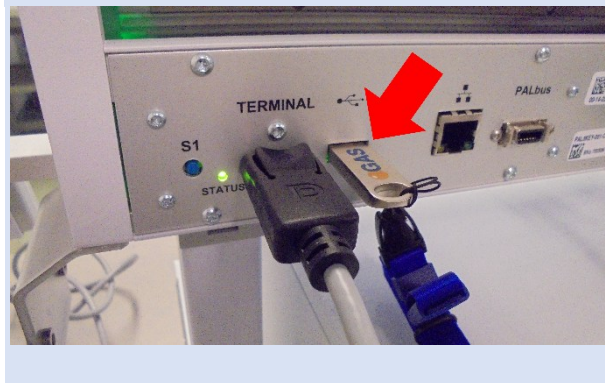

Insert a FAT32 formatted USB drive.

4

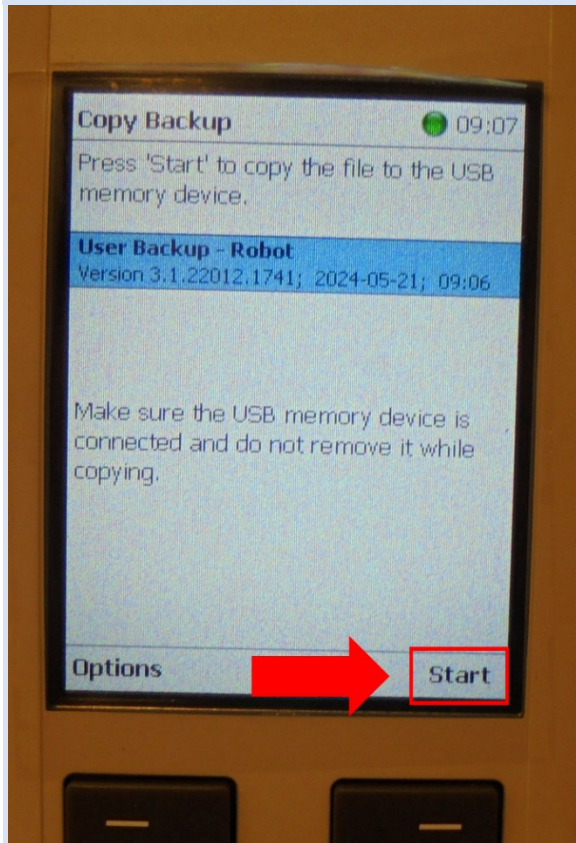

Path (in User mode or Extended User mode):
Main screen → Options → Maintenance → Copy Backup

Select **Start**.

5

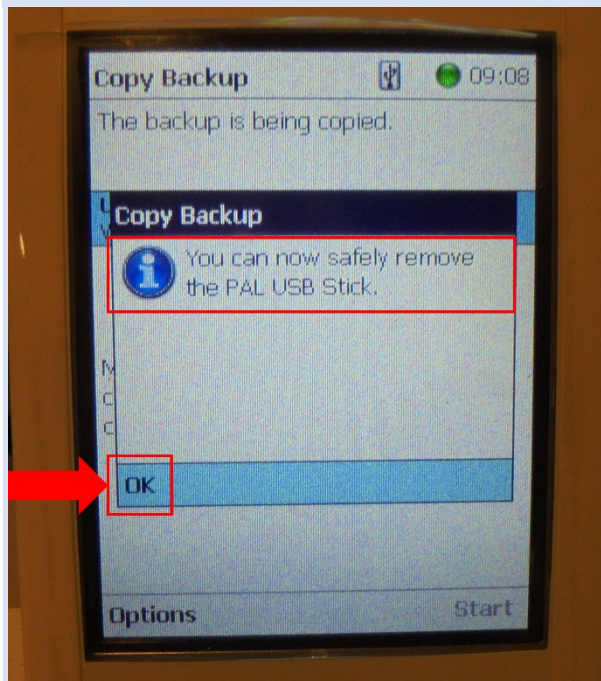

After copying the Backup to the USB drive select **OK**.

8.21 Start Sequence



INFORMATION!
 The sequence file must be created with the **G.A.S. Sequence Designer Software**. For detailed Information refer to the **G.A.S. Sequence Designer Software Manual**.

1

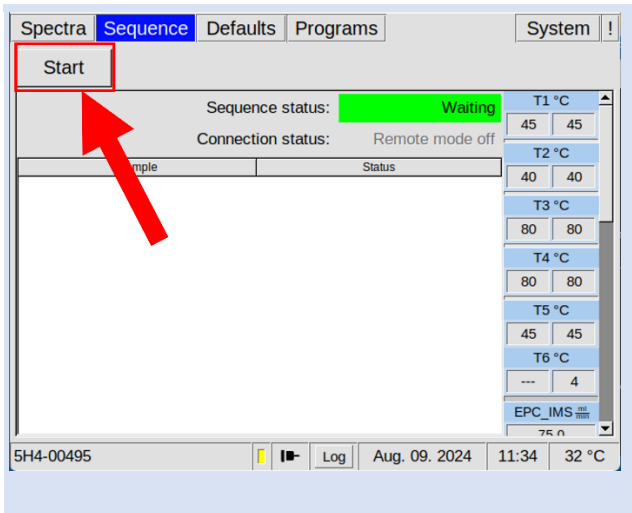

To start a sequence select:
Sequence > **Start**

2

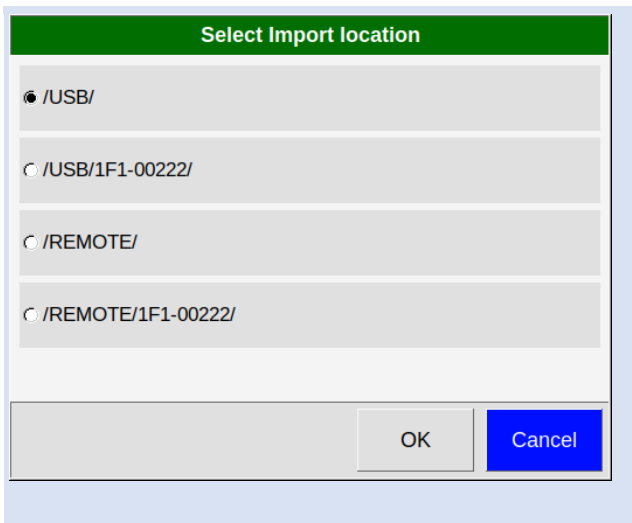

Select the import location of the sequence file named **Sequence.json**.

3

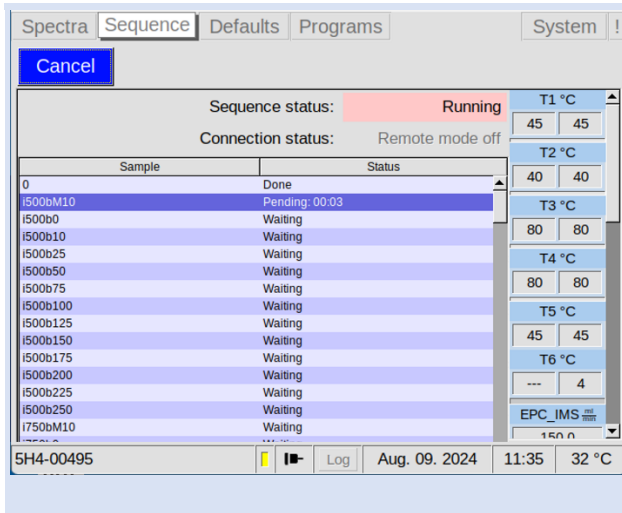

The Sequence will be executed.



INFORMATION!

If the **tfftp-protocol** is used for data transmission, the file has to be named **Sequence.json** for the software to recognize it. Make sure, that the parameters specified in the programs and after-run settings are within your devices permitted regions.



WARNING!

Be careful when changing device critical parameters by applying **After Run Settings**. A device can become inoperable with faulty IMS parameters. After Run Settings are also applied if the Sequence is cancelled by the user. In case of cancellation, the devices default parameters will be the same as if the sequence had successfully finished, taking all previous After Run Settings into consideration.



INFORMATION!

From firmware version 4.50, the use of the sequence designer from version 1.4 is mandatory.

8.22 File Transfer Setup

8.22.1 Overview

Files can be transferred to and from the device by LAN connection and by USB device connected to the USB port at the front of the housing.



INFORMATION!

A connected USB device is always preferred to a LAN connection when exporting or importing files manually.



INFORMATION!

The USB drive must be formatted to FAT32. Consult your system administrator on formatting USB drives.

Generated measurement files and measurement result files are stored on the internal storage volume of the device.

The following file types are generated from measurements:

File Type	Description
MEA Measurement Files	Contains the complete data of one single measurement including the raw sampling data.

When a connection to a server is established and the export is activated these files are copied to this server when created in the workflow. Measurement files once copied to one of these locations are marked and will be overwritten in case the internal storage is full.

By default the **Service Message Block Protocol (SMB)** also known as Common Internet File System (CIFS) is used. The **Secure File Transfer Protocol (SFTP)** or a modified version of the **Trivial File Transfer Protocol (TFTP)** can also be used. LAN file transfer settings can be modified in **System** > **Transfer** > **Connection** > **Edit Server Details**.

Manual transfer of measurement files stored on the device can be done **System** > **Transfer** > **Mea Files** > **Copy to Remote**.

Manual deleting of measurement files stored on the device can be done **System** > **Transfer** > **Mea Files** > **Delete**.

8.22.2 Connecting to a Server in a LAN



INFORMATION!

Some PC Ethernet interfaces may not be suited for a direct connection to the device. In that case consider using an Ethernet switch to connect both devices.

1a

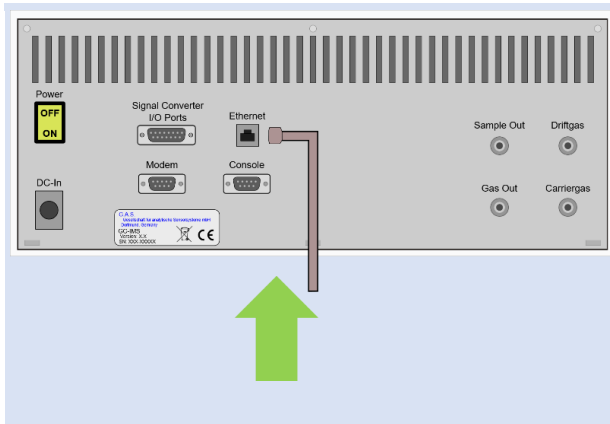

Connect the device with a standard Ethernet cable (LAN cable) to the LAN or directly to a computer.

1b

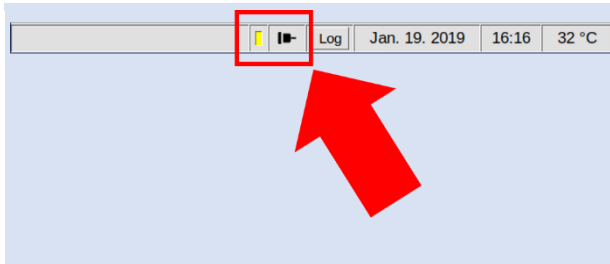

In the status bar the connection icon is displayed.



INFORMATION!
Make sure that any firewall present in the network does not block necessary traffic. Consult your system administrator on how to configure your firewall.



INFORMATION!
Consult your system administrator on how to set up a server with one of the protocols **SMB** and **SFTP**. The **TFTP** protocol requires the G.A.S. TFTP Server software to run on a Microsoft® Windows® computer.

2a
Option

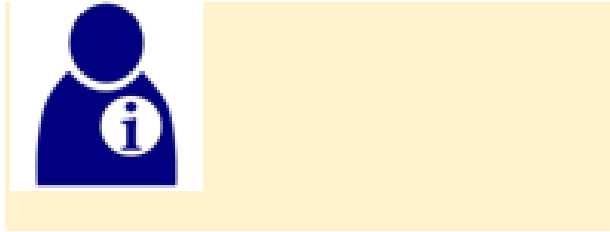

For **SMB** set up a SMB share on a server. Consult your system administrator on how to do that.

2b
Option



For **SFTP** set up a SFTP server. Consult your system administrator on how to do that.
For an example SFTP server for Microsoft® Windows® PCs see:
<http://www.coreftp.com/server>

2c

Option



For **TFTP** install the G.A.S. IMS-Control TFTP-Server on the PC. For detailed information see the **IMS Software Suite IMScontrol TFTP-Server manual**.

3a

Option

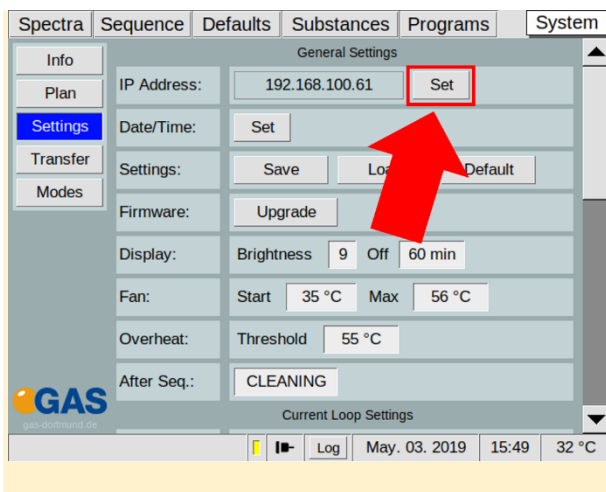

Set a static device IP (Recommended for direct connection of PC and device):

Use **System** > **Settings** > IP Address: **Set**

In the next dialog box select: **Yes**

3b

Option

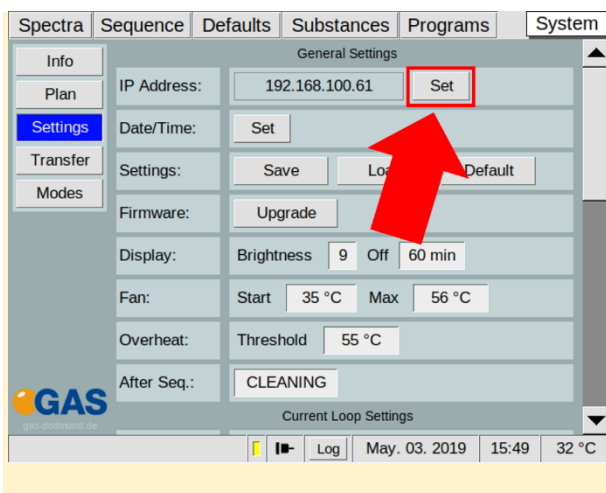

Get device IP From DHCP Server

(Recommended for LAN integration of the device): Use **System** > **Settings** > IP Address: **Set**

In the next dialog box select: **No**



INFORMATION!

Note that both devices must be in the same subnet mask area of **255.255.255.0** i.e. only differ in the fourth number of the four-part IPv4 address.

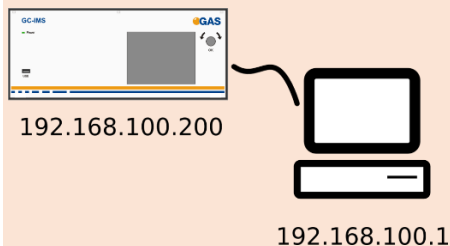

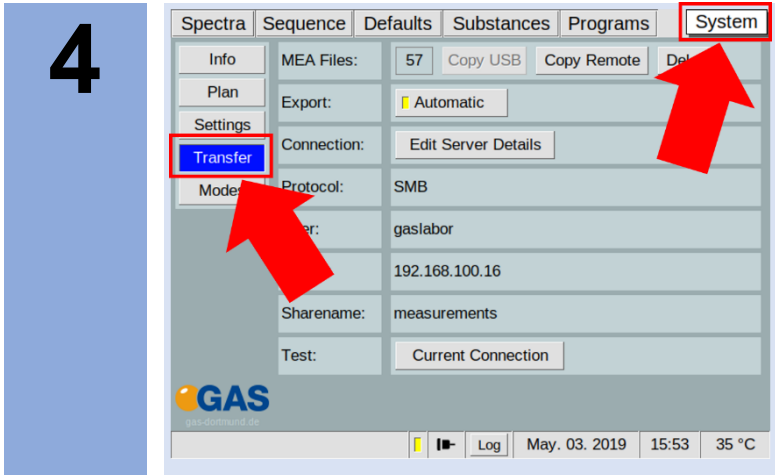

Open **System** > **Transfer**

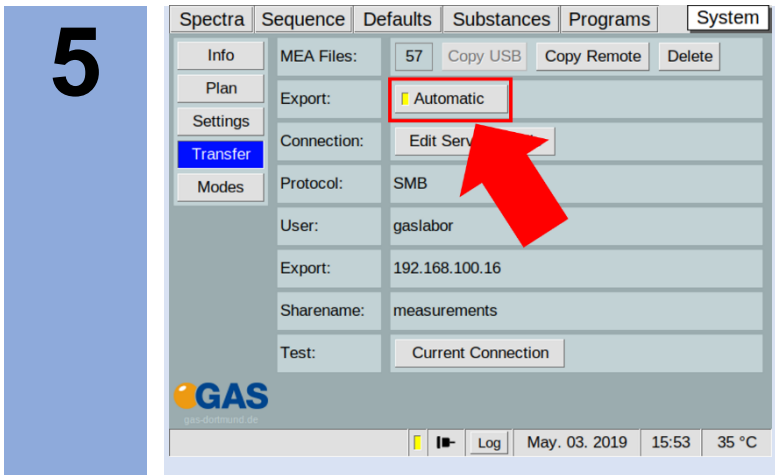

Activate or deactivate automatic file transfer to the server with Export: **Automatic**.

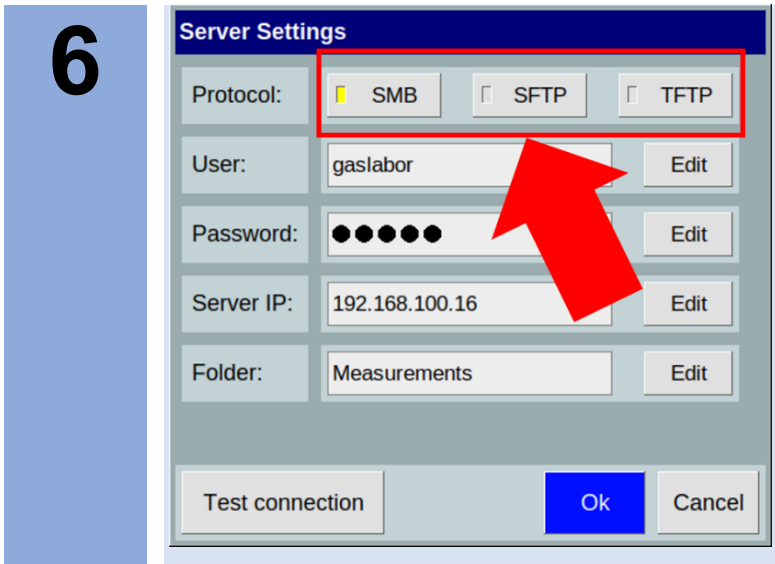

Select the desired protocol **SMB**, **SFTP** or **TFTP**.

7a
Option

For **SMB** enter **Server IP Address**, **Folder** name, **User** name and **Password** for the SMB share on the server.

7b
Option

For **SFTP** enter **Server IP Address**, **Port**, **User** name and **Password** for the SFTP server.

7c
Option

For **TFTP** enter the **Server IP Address**.

8

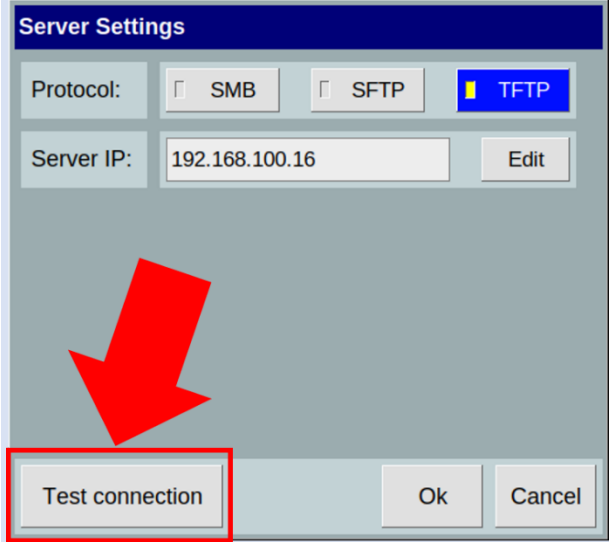

Test the connection with **Test connection**.



INFORMATION!

When the connection cannot be established check the Ethernet cable connection. Main the network IP address of the server, the used protocol, the name of the shared folder (**SMB**) on the server and the server account login data (**SMB**, **SFTP**). Consult the manuals of your server operating system and your system administrator.

9

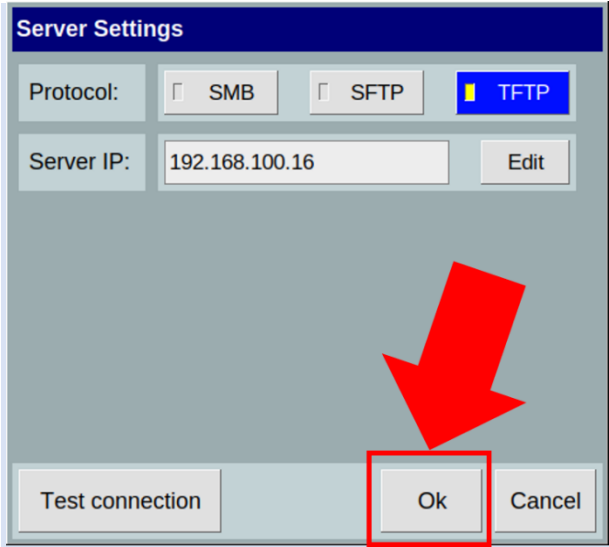

Close dialogue with **OK**.

8.22.3 Manual Transfer of measurement files to USB-Stick



INFORMATION!

Do not turn off the device during the download process!

1



Connect the USB drive (FAT32-formatted) to the USB socket at the front side of the housing.

2

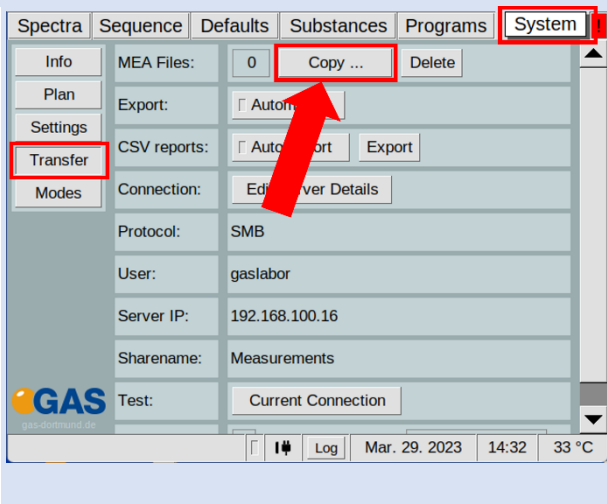

Open page: System > Transfer.

Press: Copy.

3

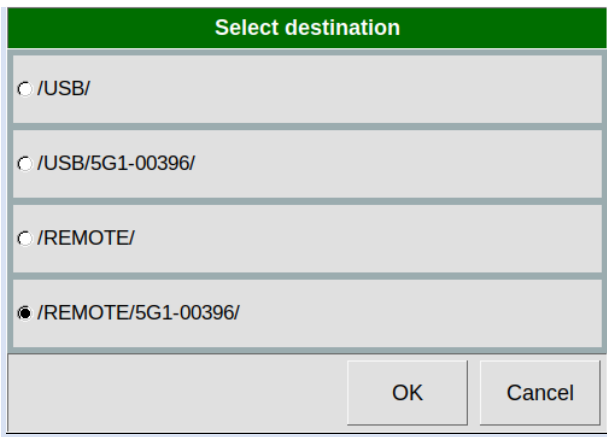

A confirmation dialog appears. Select the storage location (USB or REMOTE)

Press OK to start the process.

4

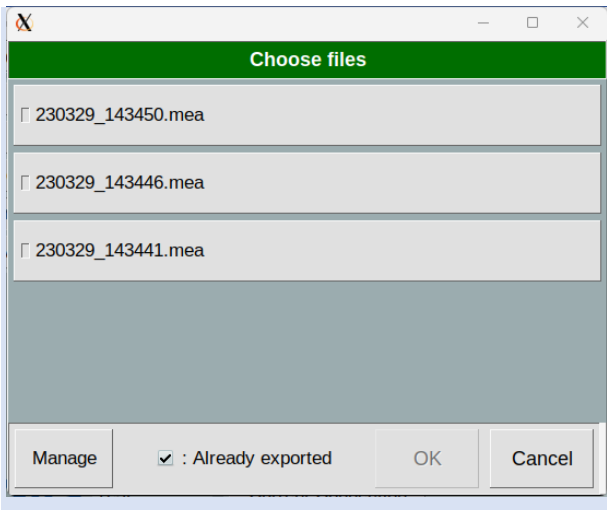

Select the files to be exported manually or use the Manage button to select all.

5

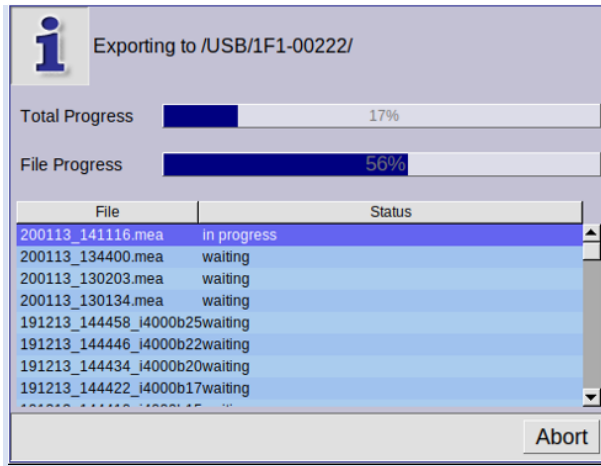

Wait until the exporting process is completed.

6a

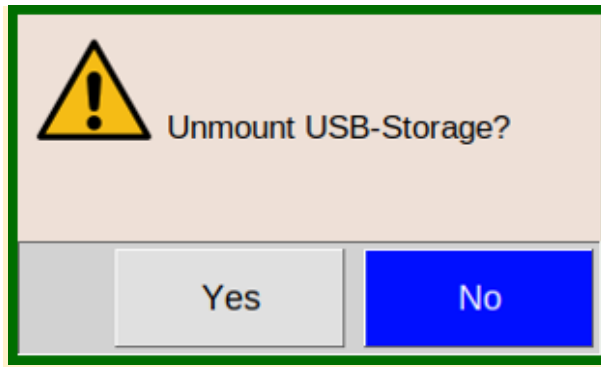

A confirmation dialog appears. Press **OK** to unmount the USB-Storage.

6b

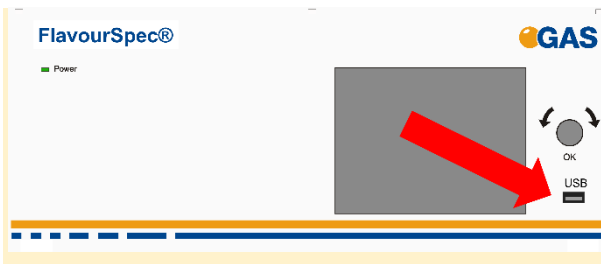

Remove the connected USB drive from the **USB** socket at the front side of the housing.



The measurement files has been downloaded.

8.23 Start Cleaning mode



INFORMATION!
In case of contamination it is helpful to activate the **cleaning mode** to clean the system.

1

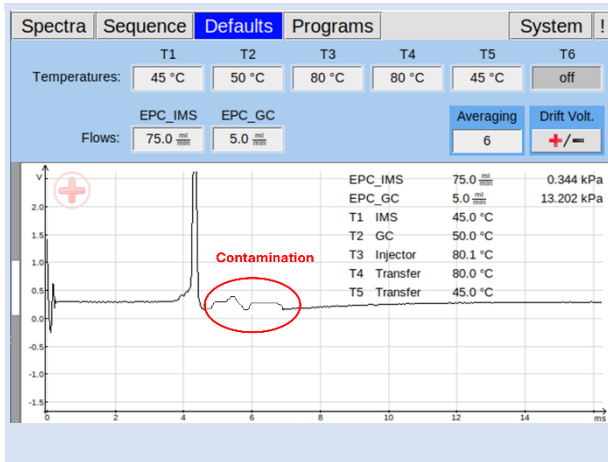

In case of contamination it is helpful to activate the **cleaning mode** to clean the system.

The frequency of cleaning interval is depending on the character and quantity of the samples.

2

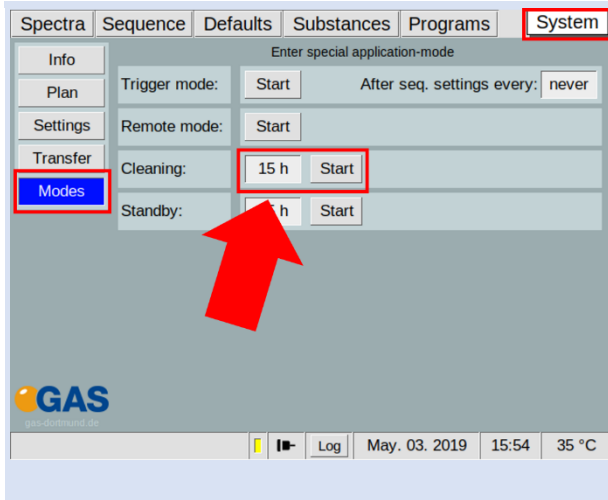

Select **System** > **Modes** > **Cleaning [x h]** and set the cleaning duration time.

Select **Start** to start the cleaning process.

All temperatures are set up to their maxima.

3

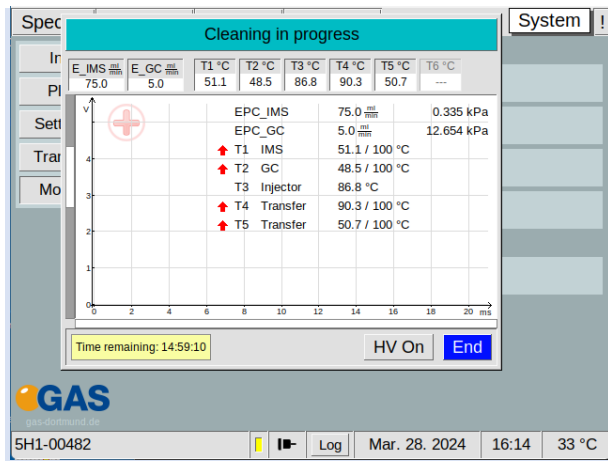

During the cleaning process a **Cleaning window** appears. During this process no other activities can be executed.

This process can be skipped at any time.

8.24 Start Standby mode

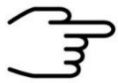

INFORMATION!

It is recommended not to switch off the device during measurement breaks. Using the standby mode ensures that the system is clean and ready for measurement quickly.

1

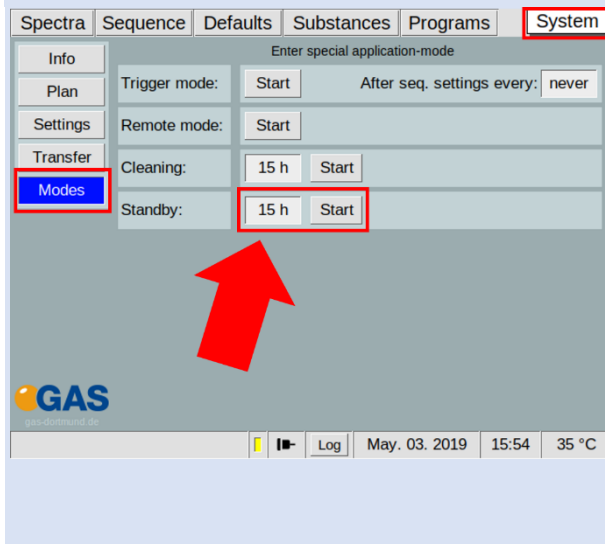

Select **System** > **Modes** > **Standby [x h]** and set the standby duration time.

Select **Start** to start the standby process.

Drift gas (EPC_IMS) is set to **10 ml/min** and carrier gas (EPC_GC) is set to **5 ml/min**.

2

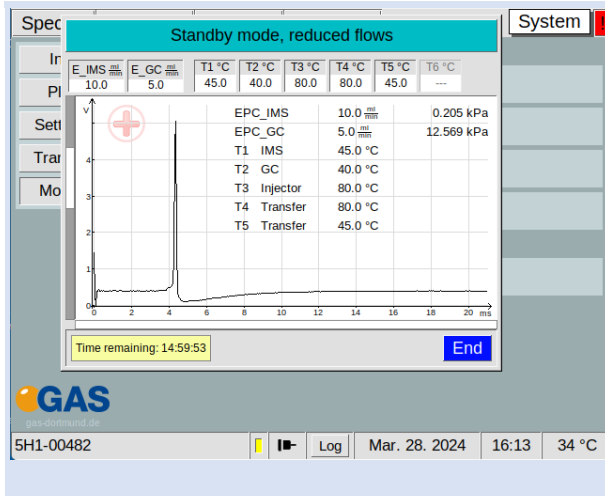

During the standby process a **Standby window** appears.

During this process no other activities can be executed.

This process can be skipped at any time.

8.25 Remove the Housing Cover



DANGER!

Before all work on the device **switch off the device** and **pull out the power plug!**

1



Switch off the device and pull out the power plug.

2a



Open the side covers of the case carefully using a screwdriver.

2b



Remove the side covers of the case carefully.

2c

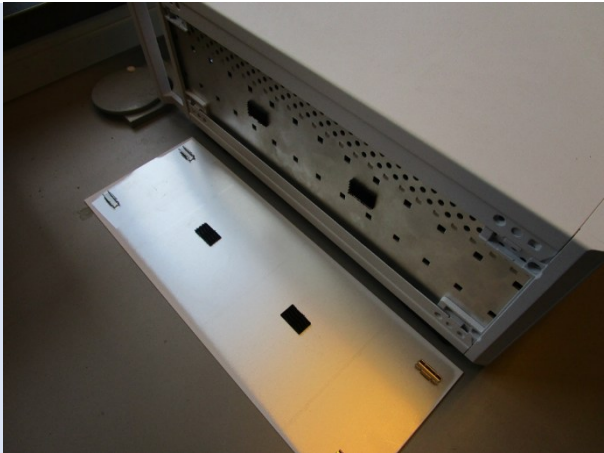

Removed side cover.

3a



Open the top cover of the case carefully using a screwdriver.

3b

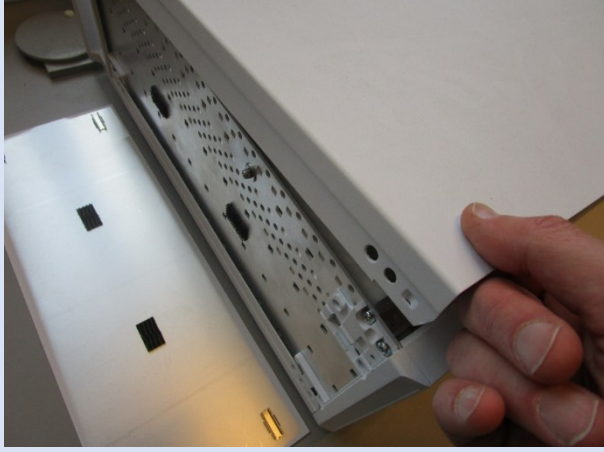

Remove the top cover of the case carefully.

4



Device without top cover.

8.26 Change Capillary Column



DANGER!

Before all work on the device **switch off the device** and **pull out the power plug!**

1

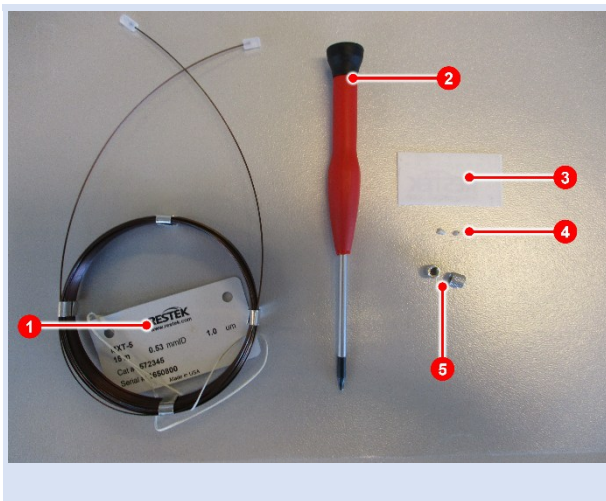

Necessary tools:

1. Capillary column
2. T10 Torx screwdriver
3. Column cutter
4. Peek ferrule with hole (depending on the column dimensions)
5. Handtight screw connector

2

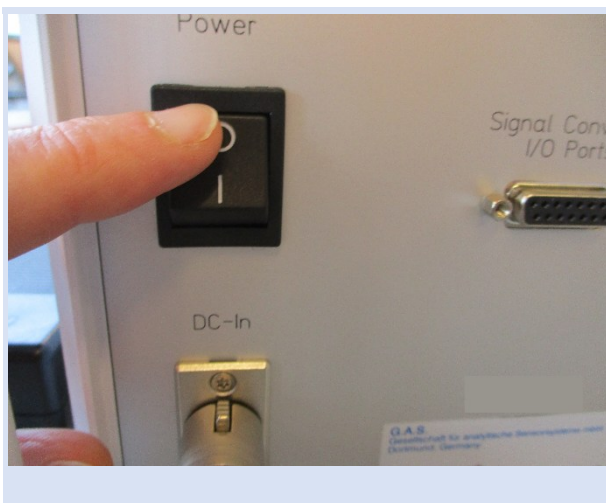

Switch off the device and pull out the power plug.

3



Remove the top cover.
For detailed information (see chapter 8.24).

4



Release all screws of the oven cover and remove it.

5

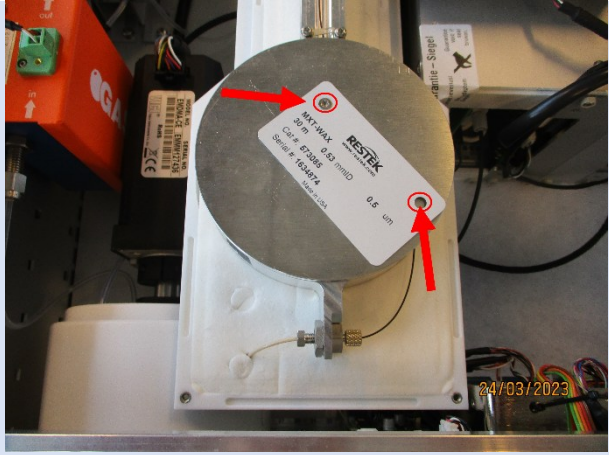

Release all screws of the inner oven cover and remove it.

6

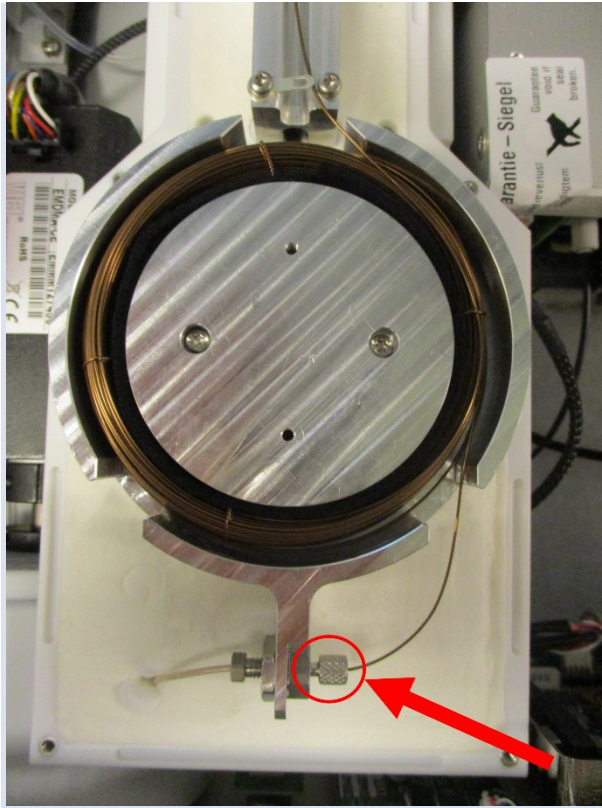

Open the front handtight screw connector.

7

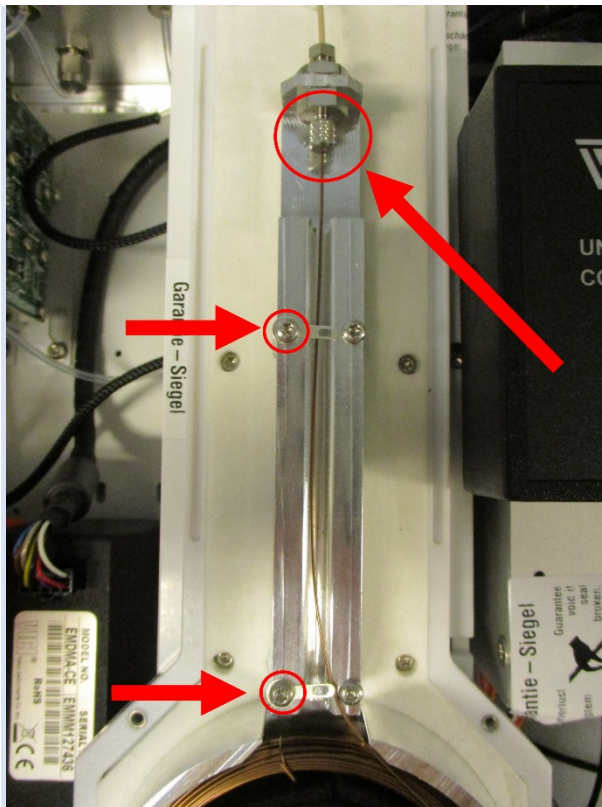

Open the rear handtight screw connector.

Also open the transfer line securing holder.

Remove the capillary column.

8

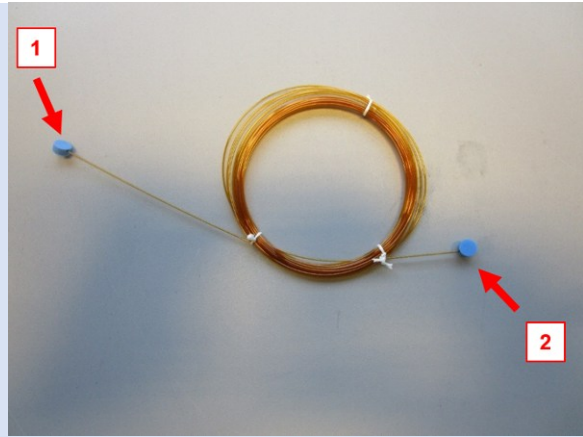

Remove the blind bolts (1) + (2) of the capillary column.

9

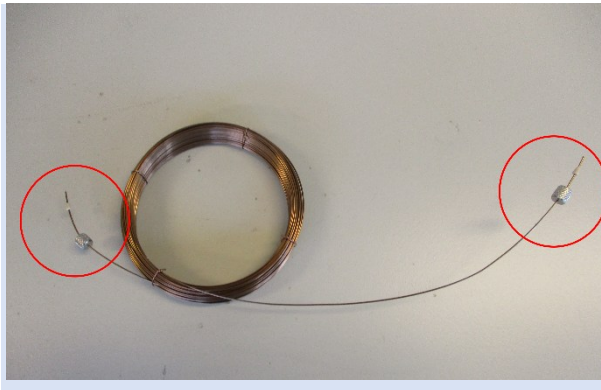

Insert the handtight screw connector and the Peek ferrules with hole.

10

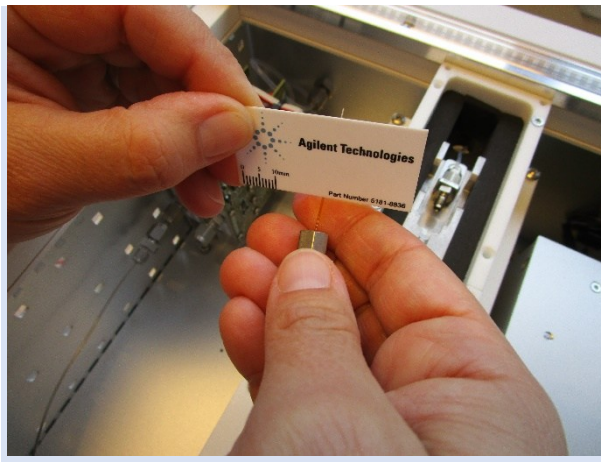

Put the new capillary column into the oven. If necessary cut the ends of the column.

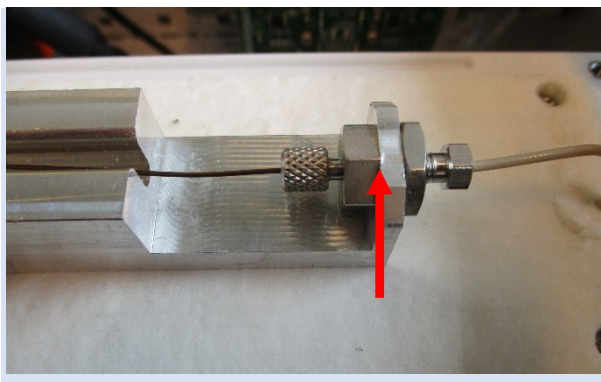

Max installation length of the column.

Shorten the column to this position

11

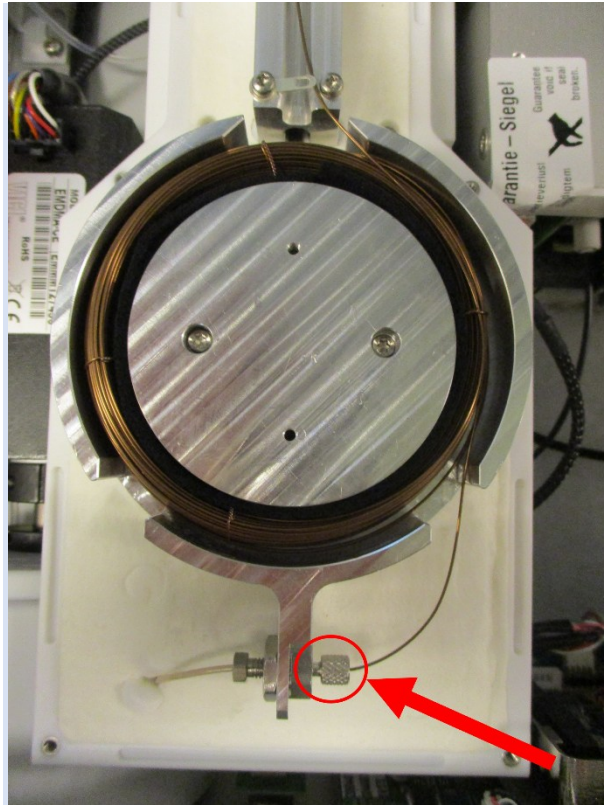

Connect the column with the front handtight screw connector.

12

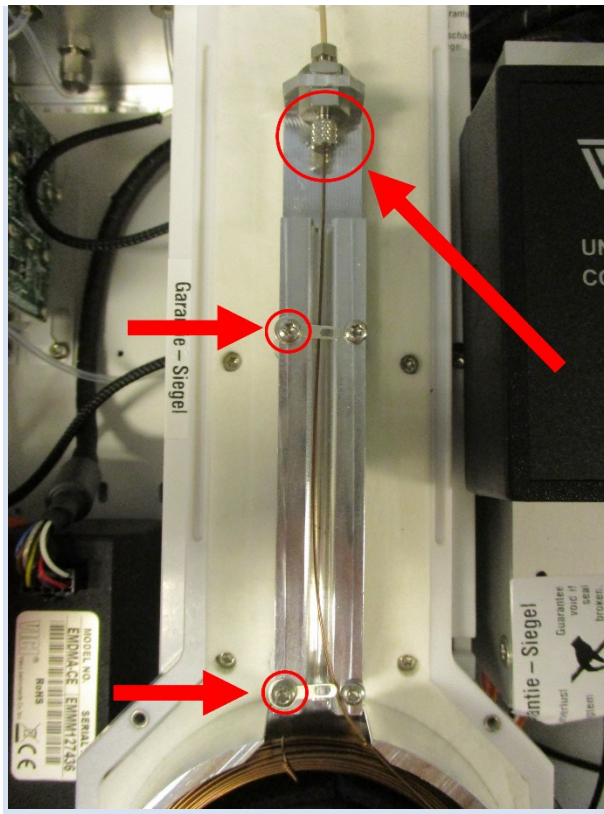

Connect the column with the rear handtight screw connector.

Also close the transfer line securing holder.

13

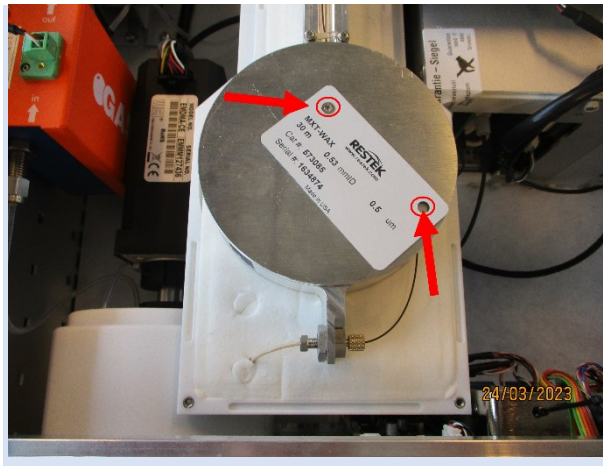

Mount the screws of the inner oven cover. Make sure that the column labeling is screwed on.

14

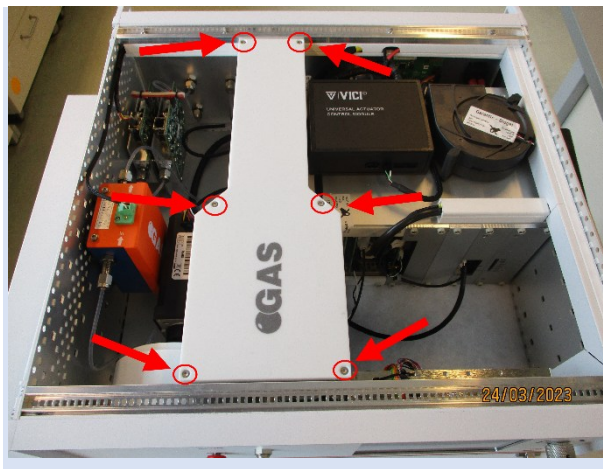

Mount the screw of the oven cover.

Fit the top cover, the bottom cover and the side cover.

Install all connections and switch on the device.

8.27 Change high voltage circuit board



INFORMATION!

Only authorized, trained and technically instructed people are allowed to do these work steps.



DANGER!

Before all work on the device **switch off the device** and **pull out the power plug!**

1



Switch off the device and pull out the power plug.

2

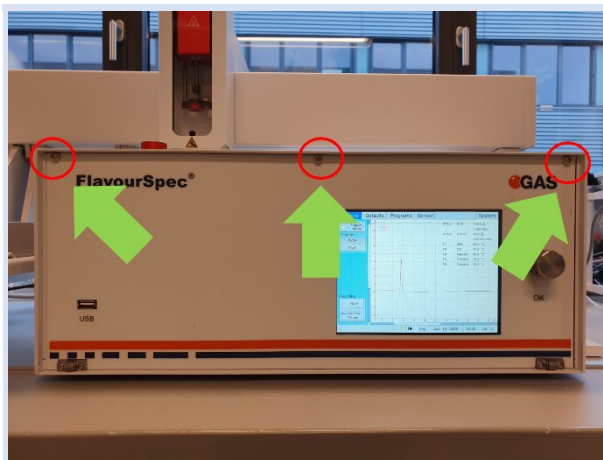

Loosen three screws at the front of the device.

3



Remove the top cover.
For detailed information (see [chapter 8.25](#)).

4

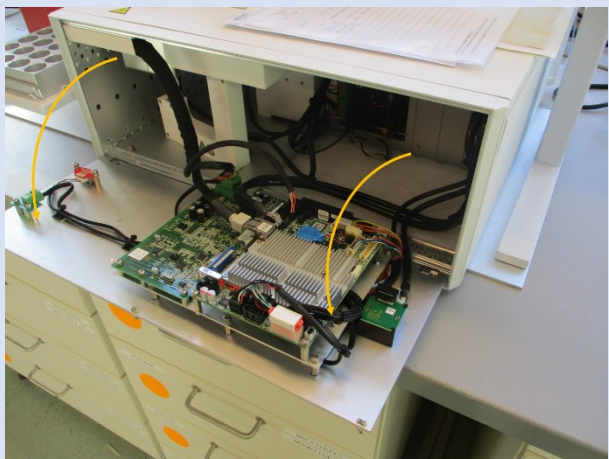

Open the front panel by carefully folding it open

5

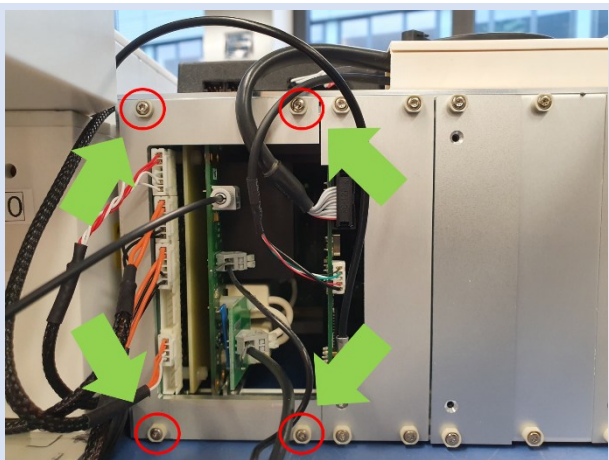

Loosen four screws with T8 screwdriver and remove the cover plate.

6

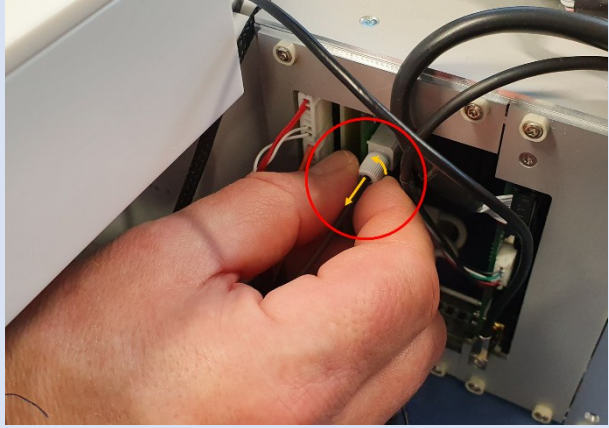

Loosen the nut from Fiberoptic transmitter and pull out fibre optic cable.

7

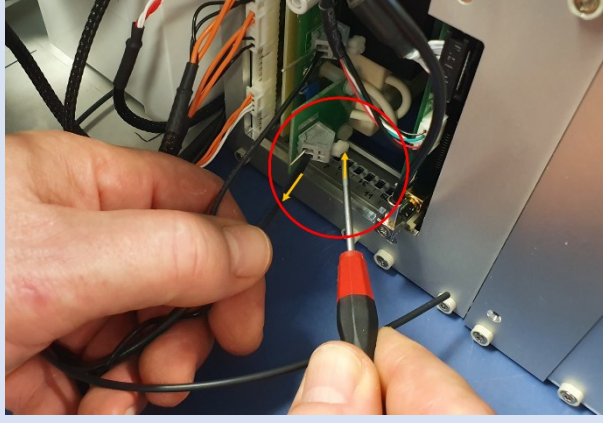

Push the button and pull out high voltage wire.

8

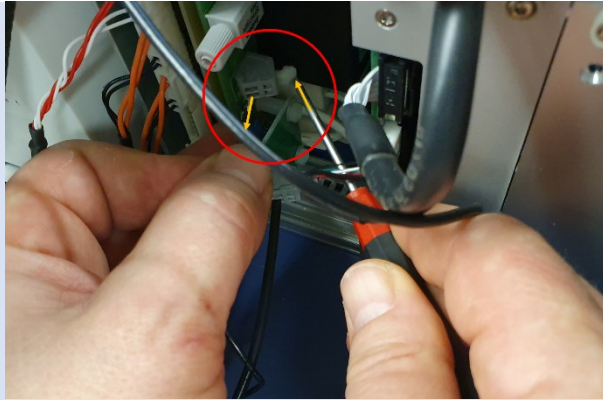

Push the button and pull out ground wire.

9



Pull the circuit board out of the casing profile.

10

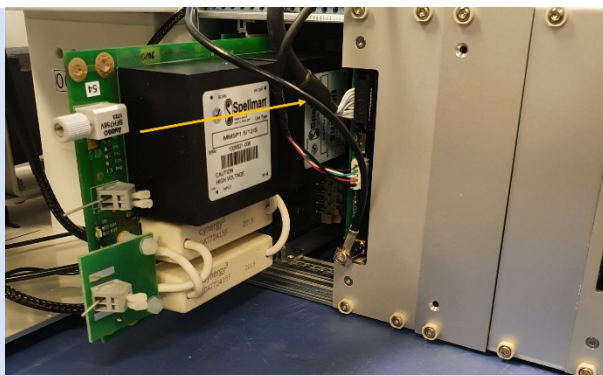

Insert the new circuit board.

11

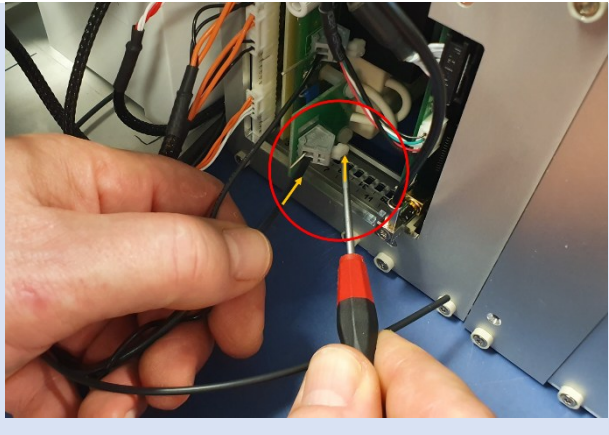

Push the button and reinsert the ground wire.

12

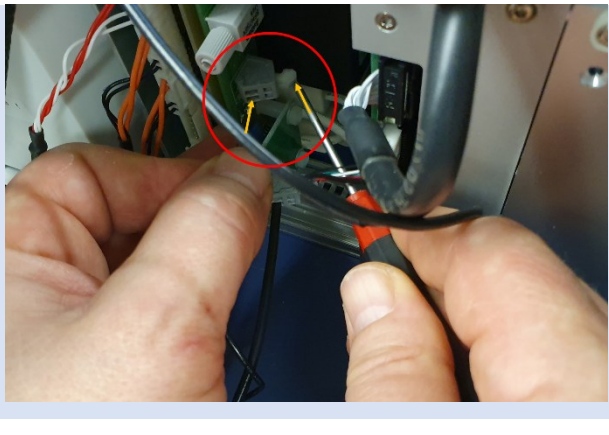

Push the button and reinsert the high voltage wire.

13

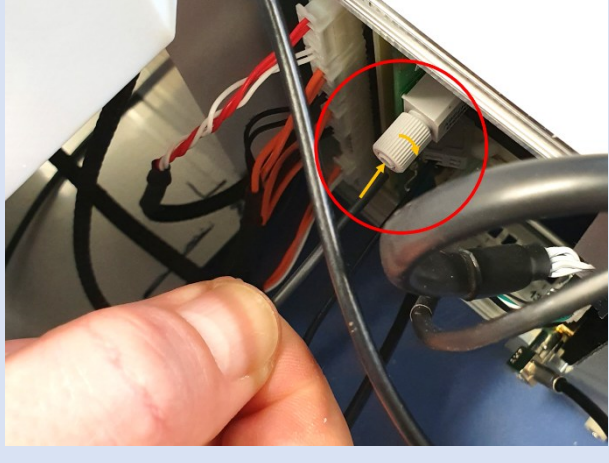

Reinsert the fibre optic cable and tighten the screw connection.

14

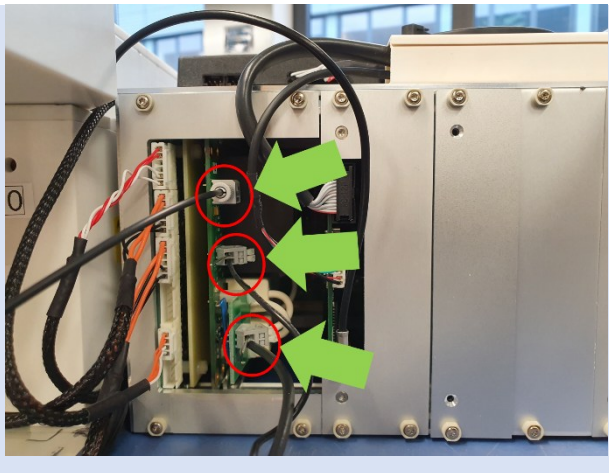

View of the three connected wires.

15

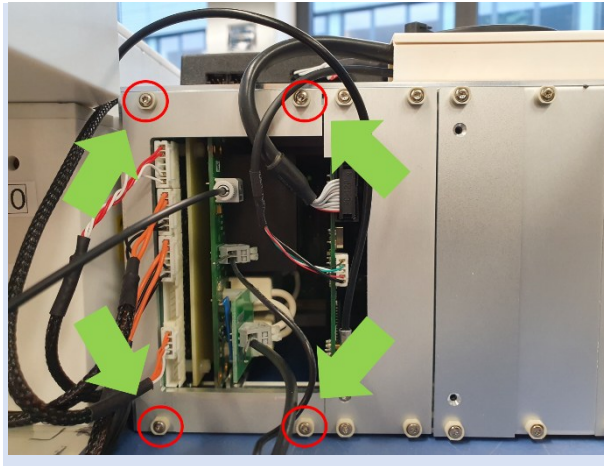

Replace the cover plate and tighten the four screws.

16

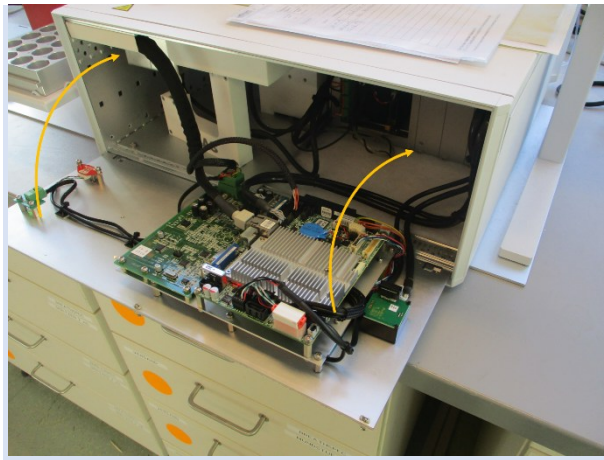

Close the front plate and attach the top cover.

17

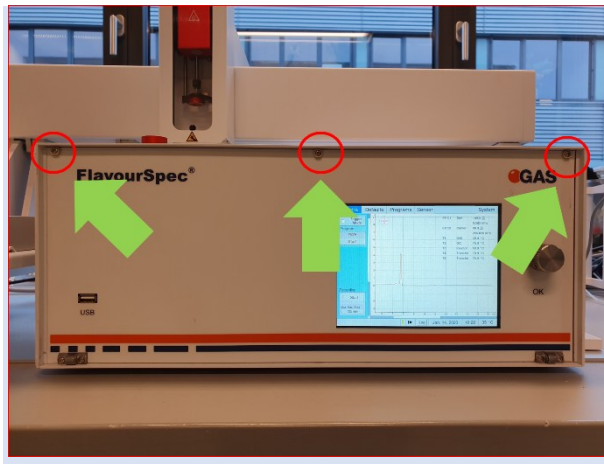

Tighten the three screws of the front panel.

8.28 Firmware Upgrade

The firmware of G.A.S. IMS devices can be upgraded by the user with an upgrade file – named update.gas - provided by G.A.S.

This file has to be put on an empty USB storage device (e.g. 'USB stick' / 'USB thumb drive') formatted as a FAT32 file system.



INFORMATION!

The USB storage device must be formatted to FAT32. Consult your system administrator on formatting USB drives.



INFORMATION!

Do not turn off the device during the upgrade process!

1

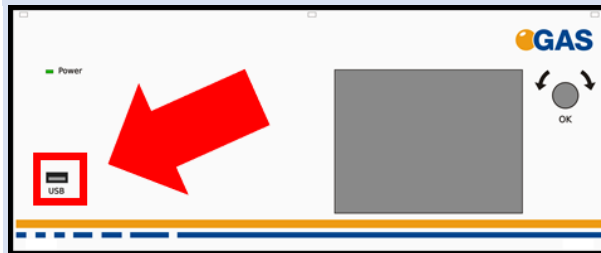

Connect the USB drive (FAT32-formatted) with the upgrade file – named **update.gas** - provided by G.A.S. to the **USB** socket at the front side of the housing.

2

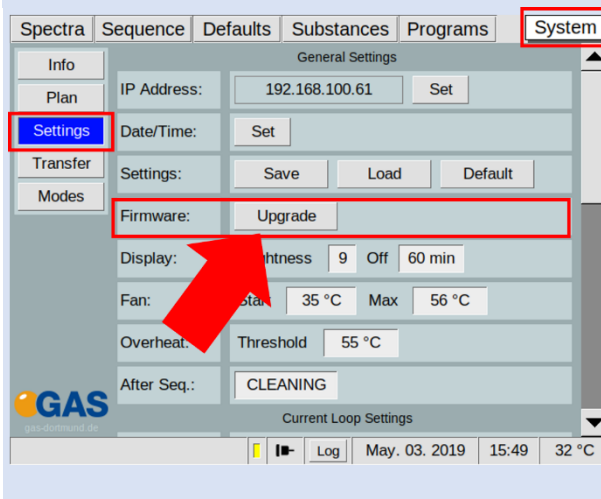

Open page:
System > **Settings**.

Press:
Firmware: **Upgrade**.

3

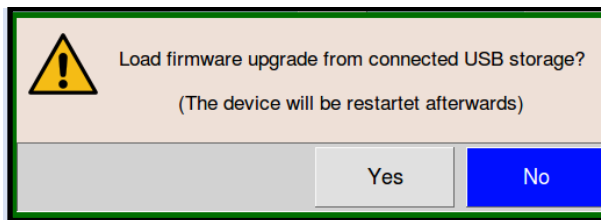

A confirmation dialogue appears.

Press **Yes** to start the process.



INFORMATION!

Do not turn off the device during the upgrade process!
Do not remove the USB drive!

The upgrade process will take one minute or more depending on the tasks that are performed during the process.

- 4



Wait until the process is completed and a system restart dialog appears.
- 5

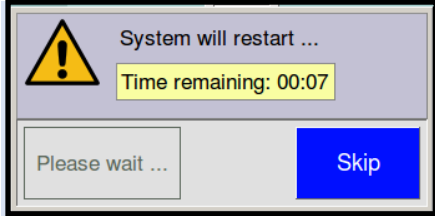

Wait for the device to restart itself or press **Skip** to restart the device immediately.
- 6

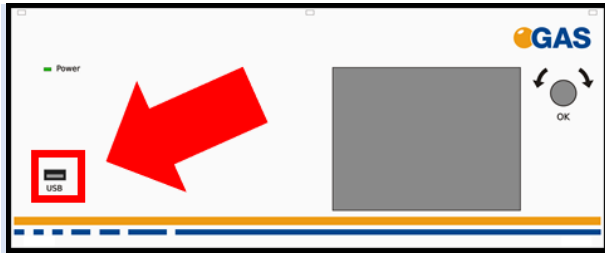

Remove the connected USB drive from the **USB** socket at the front side of the housing.
- 7



Wait until the device has started and the user interface is visible on the screen.
- 8

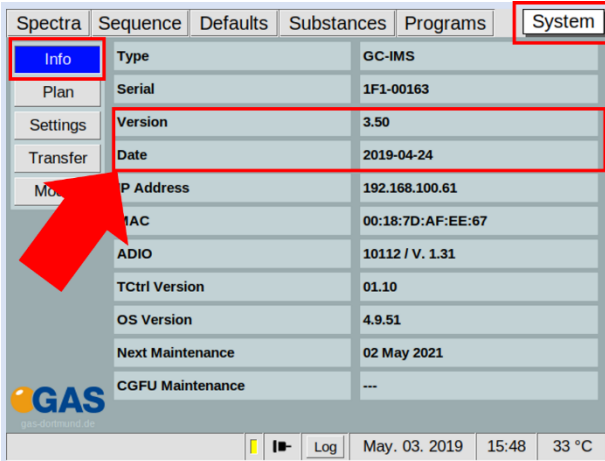

Open page: **System** > **Info**.

Verify that the new firmware version has been installed.



The device firmware has been upgraded.

8.29 Creating diagnostic information for support

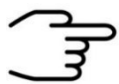

INFORMATION!
The following steps are necessary to compile the required diagnostic information. Please stick on consecution as listed below.

1



Take a picture of the instrument label on the rear side

2

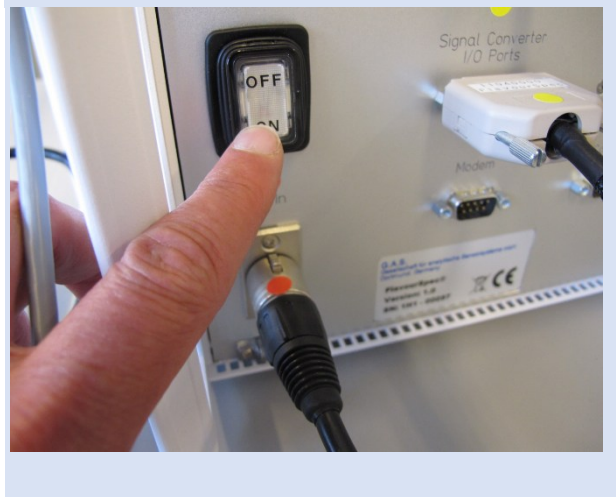

Switch on the device. Power LED front has to be illuminated.

3

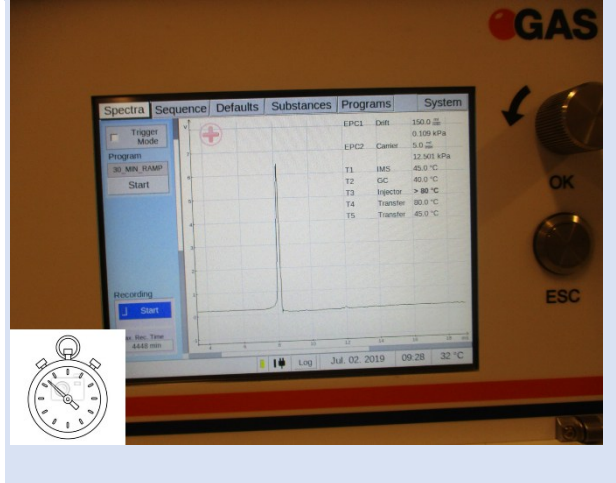

Inform how long it takes to boot up and to display of GUI in seconds. In case of error take a photo of the display.

4



Connect the USB drive (FAT32-formatted) to the USB socket at the front side of the housing.

5

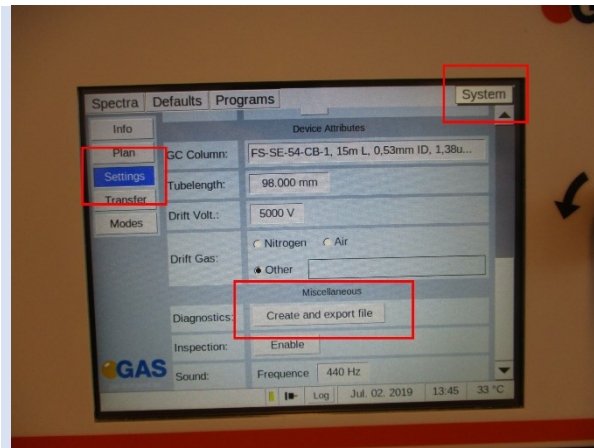

In System > Settings select Diagnostics and start the diagnostic file compilation by selecting the Create and Export file button.

6

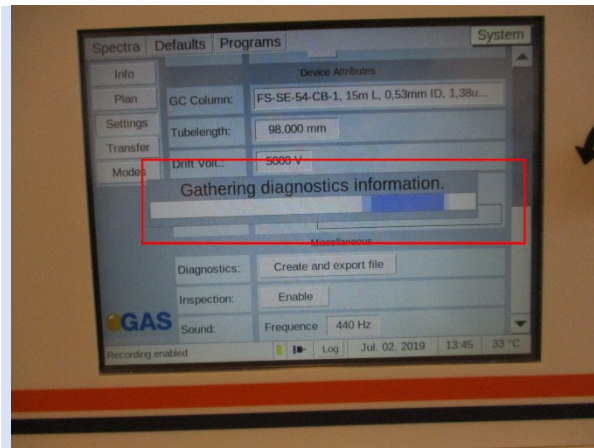

The diagnostic file is created.

7

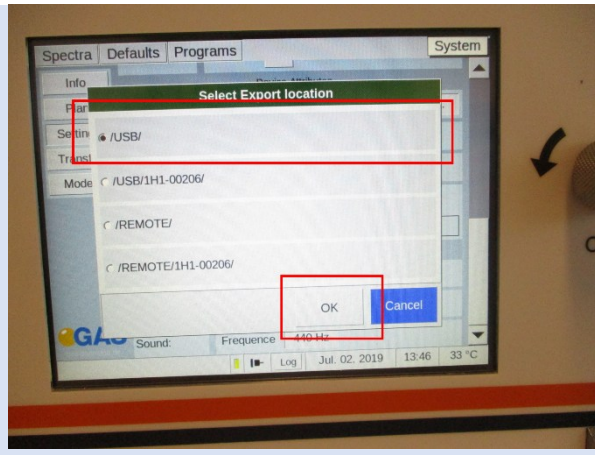

Select Export location
/USB/ and press **OK**.

8

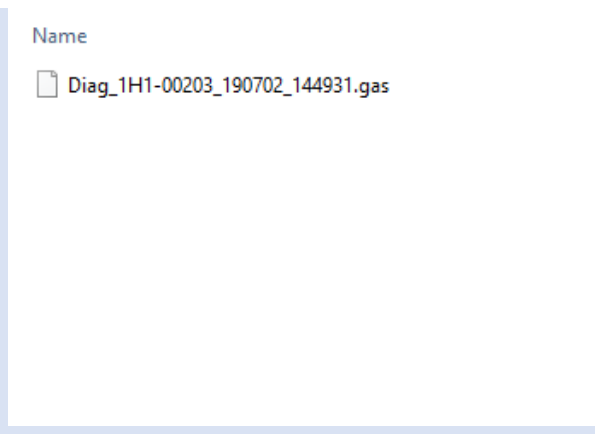

Send the **diagnostic file**
and the **photos** to
support@gas-dortmund.de

8.30 Packing FlavourSpec® for return transport



INFORMATION!

It is recommended to **use the original transport box on palett** for a safety return transport.



INFORMATION!

A suitable transport box is available from G.A.S.

1

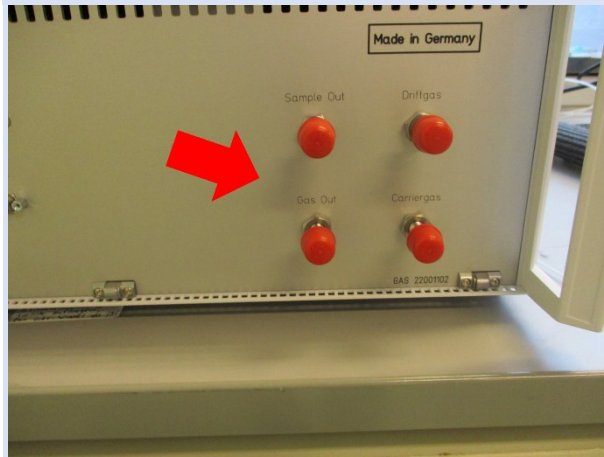

Close all gas connections with the red caps on the rear side of the device.

2

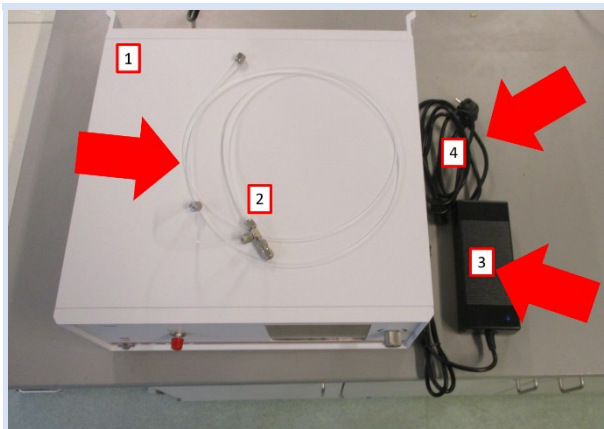

Minimum scope of delivery for the return transport:
Device **1**, Hoses **2**, power supply **3** and power plug **4**

3



It is recommended to return the system in the original box and on palett.

Further accessories can be supplied optionally.

8.31 Packing FlavourSpec® with PAL3 RSI for return transport



INFORMATION!

It is recommended to **use the original transport box on pallet** for a safety return transport.



INFORMATION!

A suitable transport box is available from G.A.S.

1

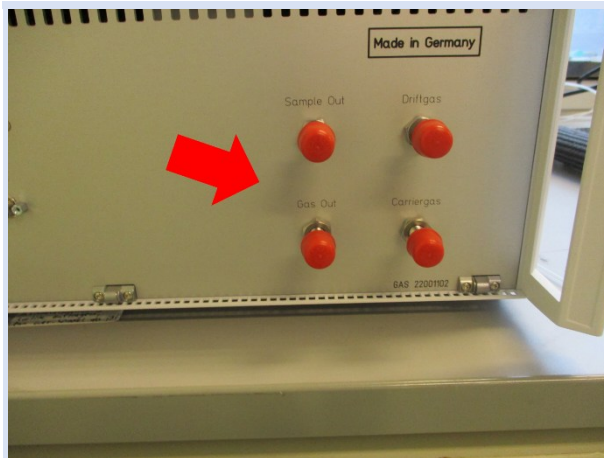

Close all gas connections with the red caps on the rear side of the device.

2

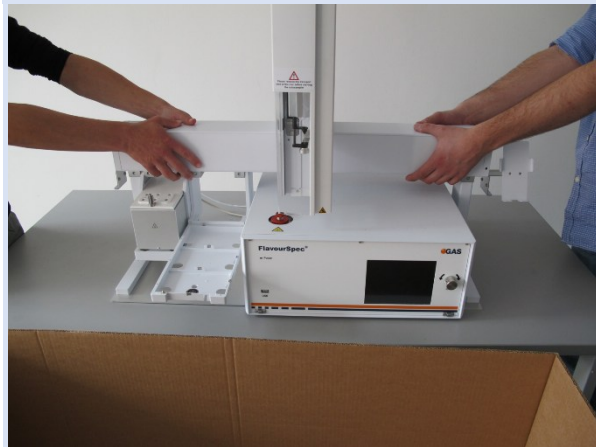

Lift the device into the box.

3

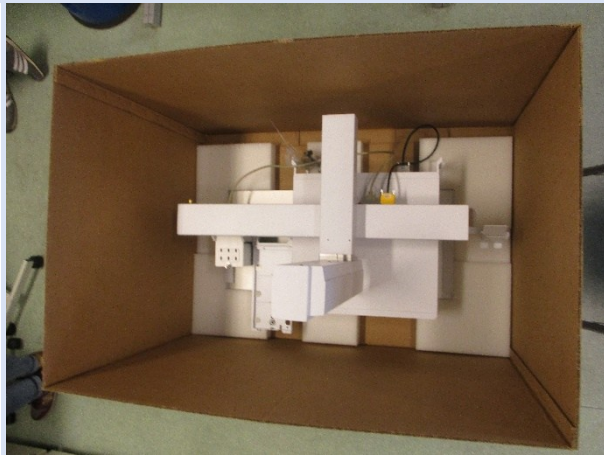

Place the device into the box.

4

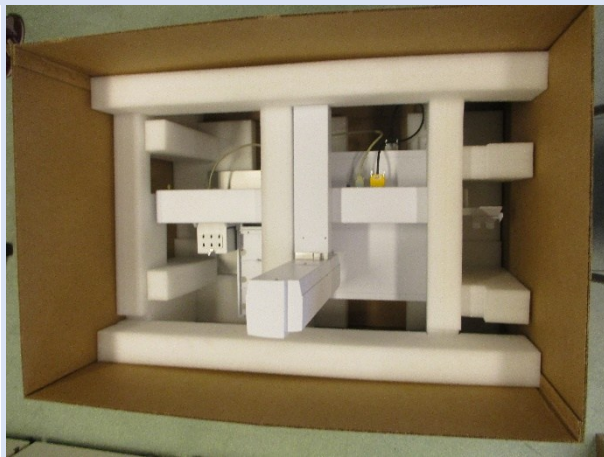

Insert the big foam spacer.

5

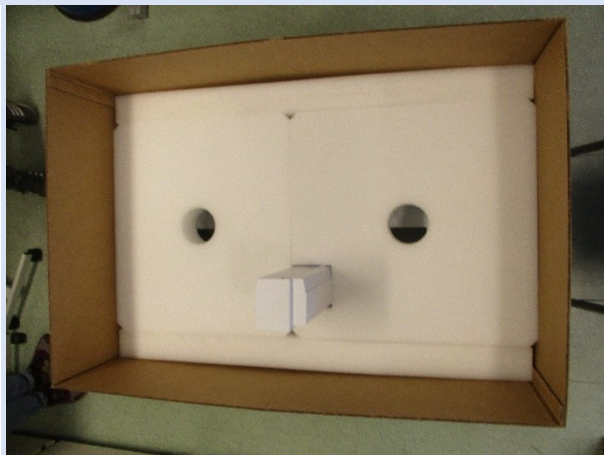

Insert both foam spacers.

6



Insert the foam spacer.

7



Insert both accessories boxes.

8



Insert both cardboard spacers and put the cover on.

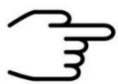

INFORMATION!

Please supply both power supply units, all connecting cables and the complete tubing with the unit.

8.32 Manual modification of the sample description attribute.

The attribute sample description can be changed manually in the measurement file. For this purpose a text editor is required, e.g. the free editor **Notepad++** [<https://notepad-plus-plus.org/>].



INFORMATION!

Only authorized, trained and technically instructed people are allowed to do these work steps. Please contact us in any case before you start working.

Only use the recommended text editor notepad++ [<https://notepad-plus-plus.org/>].

Wrong input can corrupt the measurement file.

Only work with a copy of the measurement file.

1

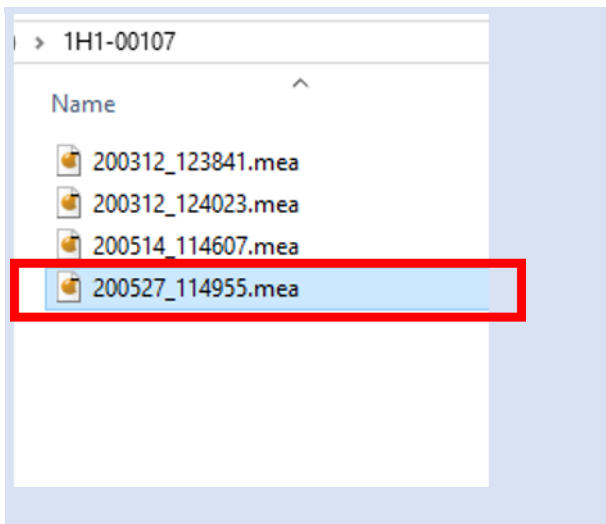

In windows explorer **select a copy** of the measurement file.

2

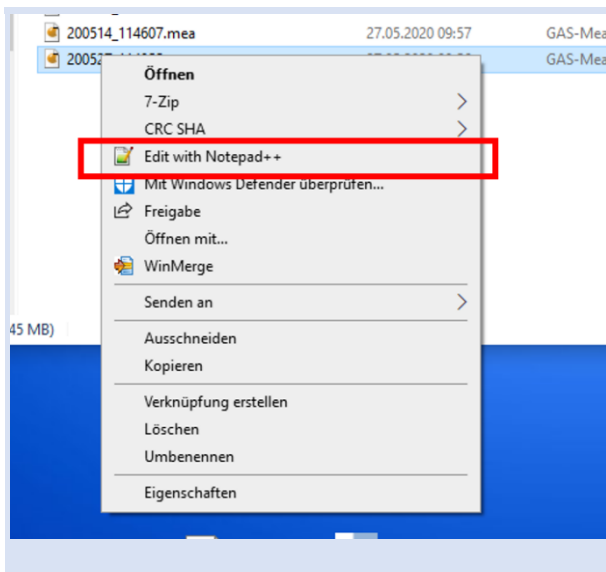

With **right click** on measurement file select **Edit with Notepad++**.

3

```

17 EPC1 pressure = 0.000 [kPa]
18 EPC2 end-pressure = 97.160 [kPa]
19 EPC2 pressure = 87.794 [kPa]
20 Filter = "SG8"
21 Firmware date = "2020-01-28"
22 Firmware version = "3.59"
23 Flow Epc 1 = "1500 1500 1497 1500 1500 .
24 Flow Epc 2 = "443 500 500 500 500 500 5
25 Flow record interval = 18000 [ms]
26 Flow1 setpoint = 150.0 [ml/min]
27 Flow2 setpoint = 50.0 [ml/min]
28 GC Column = "MXT-5, 15m L, 0,53mm ID,
29 Machine name = "GAScontrol"
30 Machine serial = "1H1-00226"
31 Machine type = "FlavourSpec®"
32 nom Drift Potential Difference = 5000 [V]
33 nom Drift Tube Length = 98000 [µm]
34 Pressure Ambient = "99943 99942 99942 99942 9
35 Pressure Epc 1 = "805 812 809 809 810 809 8
36 Pressure Epc 2 = "87794 97152 96983 97156 9
37 Pressure record interval = 18000 [ms]
38 Program = "Name= 30_min |avg=0|ras
39 Sample = "mea_2"
40 Sensor block = 100 [dgt]
41 Sensor data = "00050109, 01/2020, 10347
42 Sensor drift = 240 [dgt]
43 Sensor inject = 2500 [dgt]
                
```

In the opened measurement file find the attribute **Sample**.

4

```

Pressure record interval = 18000 [ms]
Program = "Name= 30_min |avg=0|ras
Sample = "mea_2"
Sensor block = 100 [dgt]
Sensor data = "00050109,
Sensor drift = 240 [dgt]
                
```

Change sample description **(Entry** between the quotation marks).

Save the measurement file.

8.33 Switching the screen interface from English to Chinese



INFORMATION!

The screen interface can be switched from English to Chinese as of firmware version 4.70.

The language can be changed in the system window line Language.

This line is only available for systems for the Chinese market.

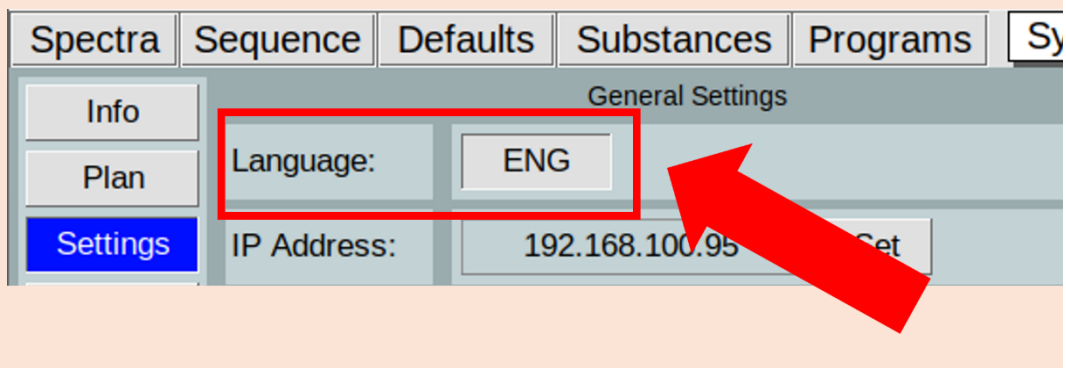

1

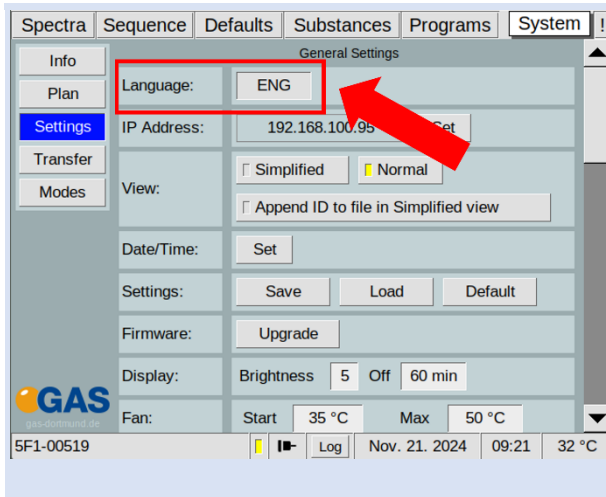

Press the button for the set language (default English ENG).

2

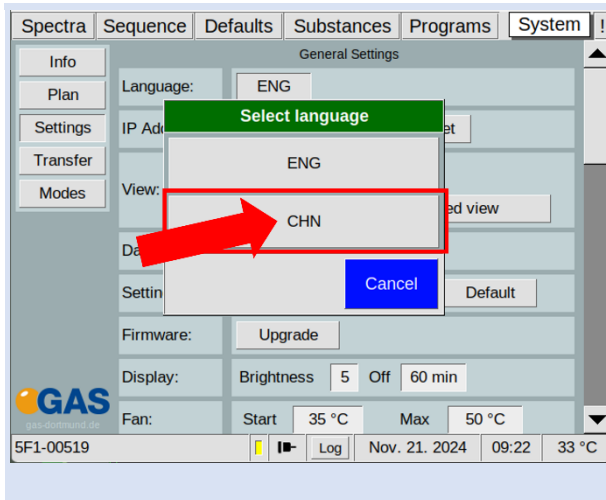

In **Select language window** select **CHN** for chinese language.

3

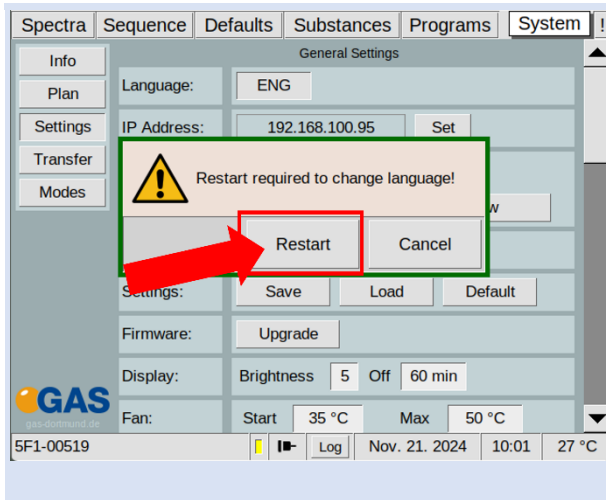

In the next window select **Restart**.

4



After the restart, the screen interface is displayed in Chinese.

9 Appendix

9.1 Technical data: FlavourSpec®

Dimensions	<ul style="list-style-type: none"> • Housing: 19"-compatible • Height: 184.5 mm • Width: 449 mm • Depth 435 mm • Weight: ca. 15 kg
Operational conditions	<ul style="list-style-type: none"> • Temperature range: +5°C ... +40°C • Humidity: 0-90% RH, non-condensing
Electrical Connectors	<ul style="list-style-type: none"> • 2 x RS232 DE9 plug • 1 x I/O DA15 socket • 1 x Ethernet RJ45 IEEE 802.3 100BASE-T • 1 x USB 2.0 Host (USB A Connector) • 1 x XLR 3-pole male, for power supply
Power Supply	<ul style="list-style-type: none"> • Input line voltage: Grounded AC, 85 to 264V • Input line frequency: 47-63 Hz • Input current: < 2.8 A • Output voltage: 24 VDC • Output current: 9.2 A internal • Power consumption: < 221 Watt
Cooling	<ul style="list-style-type: none"> • Axial ventilator, temperature-controlled, max. 5.5 m³/h
Gas connectors	<ul style="list-style-type: none"> • 3 mm stainless steel Swagelok-connector.
Internal hoses	<ul style="list-style-type: none"> • PFA
IMS-parameters	<ul style="list-style-type: none"> • Drift tube length: 53 mm • Electrical field strength: 500 V/cm • Resolution: ~ 45 • Operating temperature: 35–80°C
Ionisation source	<ul style="list-style-type: none"> • Radioactive - Tritium H³ (β⁻ Radiation)

<p>Data acquisition</p>	<ul style="list-style-type: none"> • Sample-Rate: 150 kHz • Resolution: 14 bits • Trigger-duration: 100 µs • Trigger-repetition rate: 21 ms
<p>Drift voltage</p>	<ul style="list-style-type: none"> • 2.7 kV Positive/negative drift voltage switchable
<p>Sampling system</p>	<ul style="list-style-type: none"> • Injector – Splitless • Injector Operation temperature: 35 – 200°C (default 80°C) • Operation temperature: 35 – 100°C (default 45°C) • Temperature display accuracy: ± 1°C • Temperature control accuracy: ± 0.1 K
<p>Data storage</p>	<ul style="list-style-type: none"> • Internal storage volume • Data transfer via LAN-connection via SMB, SFTP or TFTP (G.A.S. variant of TFTP)
<p>Operation</p>	<ul style="list-style-type: none"> • 6.4" TFT Touchscreen • Pushable rotary knob
<p>Standard Gaschromatic Capillary Column (Other Column types only on request)</p>	<ul style="list-style-type: none"> • Standard Stationary Phase: <ul style="list-style-type: none"> • (5% diphenyl, 95% dimethylpolysiloxane) • Capillary column <ul style="list-style-type: none"> • Identification: MXT-5 • Film thickness: 1 µm • Column length: 15 m • ID: 0.53 mm • OD: 0.68 mm
<p>Column oven</p>	<ul style="list-style-type: none"> • Operation temperature: 35 – 100°C • Temperature-display accuracy: ± 1°C • Temperature-control accuracy: ± 0.1°C
<p>Flow Control EPC_IMS Drift gas</p>	<ul style="list-style-type: none"> • Type: Differential pressure control • Input Pressure: 3.0 bar (300 kPa) – 6.0 bar (600 kPa) • Output Pressure Stability: 0.01% • Output Pressure Linearity: 0.05%

	<ul style="list-style-type: none"> • Operation flow rates: 0 – 500 mL/min
Flowcontrol EPC_GC Carriergas	<ul style="list-style-type: none"> • Type: Differential pressure control • Input Pressure: 3.0 bar (300 kPa) – 6.0 bar (600 kPa) • Output Pressure Stability: 0.01% • Output Pressure Linearity: 0.05% • Operation flow rates: 0 – 150 mL/min (depending on the GC-Column dimensions)
Consumables	<ul style="list-style-type: none"> • Gas nitrogen 5.0 quality or Synthetic air 5.0 quality.
Cleaning mode	<ul style="list-style-type: none"> • IMS, column and sampling system are heated up to > 100°C (~ 120°C). • Injector is heated up to ~ 200°C.

9.2 Technical data: PAL 3 RSI Series II

Dimensions	<ul style="list-style-type: none"> • Height: 770 mm • Width: 795 mm • Depth: 990 mm • Weight: ca. 24 kg
Operational conditions	<ul style="list-style-type: none"> • Temperature range: +5°C ... +40°C • Humidity: 0-80% RH, non-condensing
Power Supply	<ul style="list-style-type: none"> • Input line voltage: Grounded AC, 100 - 240 V • Input line frequency: 50-60 Hz • Input power: ~4 A • Output voltage: 36 VDC • Output current: 5.555 A • Power consumption: 200 Watt (max.)
Agitator	<ul style="list-style-type: none"> • Temperature controlled, 35–200°C, 250 - 750 rpm

Sample capacity	<ul style="list-style-type: none"> 60 Positions (6 x 10) for 20 mL Headspace Vials with 23 mm OD; 78 mm Height(Standard) and for 10 mL Headspace Vials with 23 mm AD; 47 mm Height (optional)
Syringe	<ul style="list-style-type: none"> Syringe size: 1.0 mL (Standard); 2.5 / 5.0 mL (optional)
Consumables	<ul style="list-style-type: none"> Nitrogen 5.0 or synthetic air 5.0 Gastight syringe 20 mL Headspace Vials Magnetic caps for 20 mL Headspace Vials

9.3 Technical data: I/O Interface

Device Connector Specification		
Analog output	Output type Non-loaded voltage Maximum output signal Maximum output load (burden resistance) Accuracy Linearity error Temperature coefficient Output Ripple (RMS)	Isolated active current output 0-22 mA < 20 V < 25 mA 500 Ohm better than 0.5 % (t.b.d) (t.b.d. 0,02% K) (t.b.d. < 10 µA)
	INFORMATION! Output can be set to 0-10 V voltage output by connecting internal 500 Ohm shunt restor.	
Digital input	Input type Off-state voltage On-state voltage Input current	Isolated opto-coupler input < 1 V 5 .. 30 V < 20 mA depending on input voltage

FlavourSpec®25– User Manual

Digital output	<p>Output type</p> <p>Maximum open circuit voltage</p> <p>Maximum on-state saturation voltage</p> <p>Maximum on-state current</p>	<p>Isolated passive transistor output</p> <p>30 V</p> <p>2 V</p> <p>20 mA</p>
Isolation	<p>Isolation type¹</p> <p>Surge voltage category</p> <p>Pollution degree</p> <p>Rated insulation voltage</p> <hr/> <p>¹ All in-/outputs are isolated from instrument</p>	<p>basic insulation according to EN 61010</p> <p>II</p> <p>2</p> <p>100 V DC or 100 Vrms AC</p>

Device Connector Pinout

Connector type	D-Sub DA-15 female	
Analog output	<p>Return</p> <p>Internal shunt</p> <p>Current output</p> <hr/> <p>² Connect to Pin 9 to select 0-10 V voltage output</p>	<p>Pin 1</p> <p>Pin 2²</p> <p>Pin 9</p>
Digital input	<p>Negative</p> <p>Positive</p>	<p>Pin 13</p> <p>Pin 5</p>
Digital output	<p>Negative</p> <p>Positive</p>	<p>Pin 6</p> <p>Pin 4</p>



INFORMATION!

- Do not connect any other pins.

9.4 Ionisation Source Specification



INFORMATION!

The permission and exemption limits are regulated by the Radiation Protection Ordinance and the European Union Council Directive 96/26/EURATOM in accordance with the regulations of the International Atomic Energy Authority (IAEA).

Source Type	Tritium H³, Solid-state bonded
Activity	Below the exemption limit of 1 GBq for tritium acc. to Table B (column 2) of Article 26, of the Directive 2013/59 EURATOM of December 5 th , 2013
Radiation Type	β⁻-Radiation
Radiation Energy	Average energy: 5.68 keV Maximum energy: 18.7 keV
Full Duration Half Maximum (FDHM)	12.3 years
Braking radiation	2×10^{-7} (mSv / h x GBq) $H_{\text{Brake}} = A \times h_{\text{Br}} \times (1\text{m} / r)^2$ $h_{\text{Br}} = 0.257 \times 10^{-4} \times (E_{\beta\text{max}} / \text{MeV}) \times 2$
Attenuation of Radiation	Air: 4 mm Water: < 100 μm Tissue: < 100 μm Below the exemption limit of a dose rate of 1 μSv/h at a distance of 0.1 m from any accessible surface of the apparatus acc. to

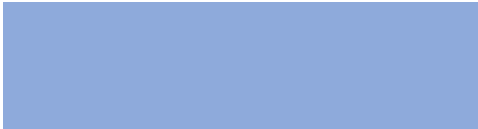

Article 26, of the Directive 2013/59 EURATOM of December 5th, 2013

Mounting Location and Type

Fixed inside the device and not accessible from the outside. The source cannot be touched directly.

9.5 Technical drawing: Internal Gasflow

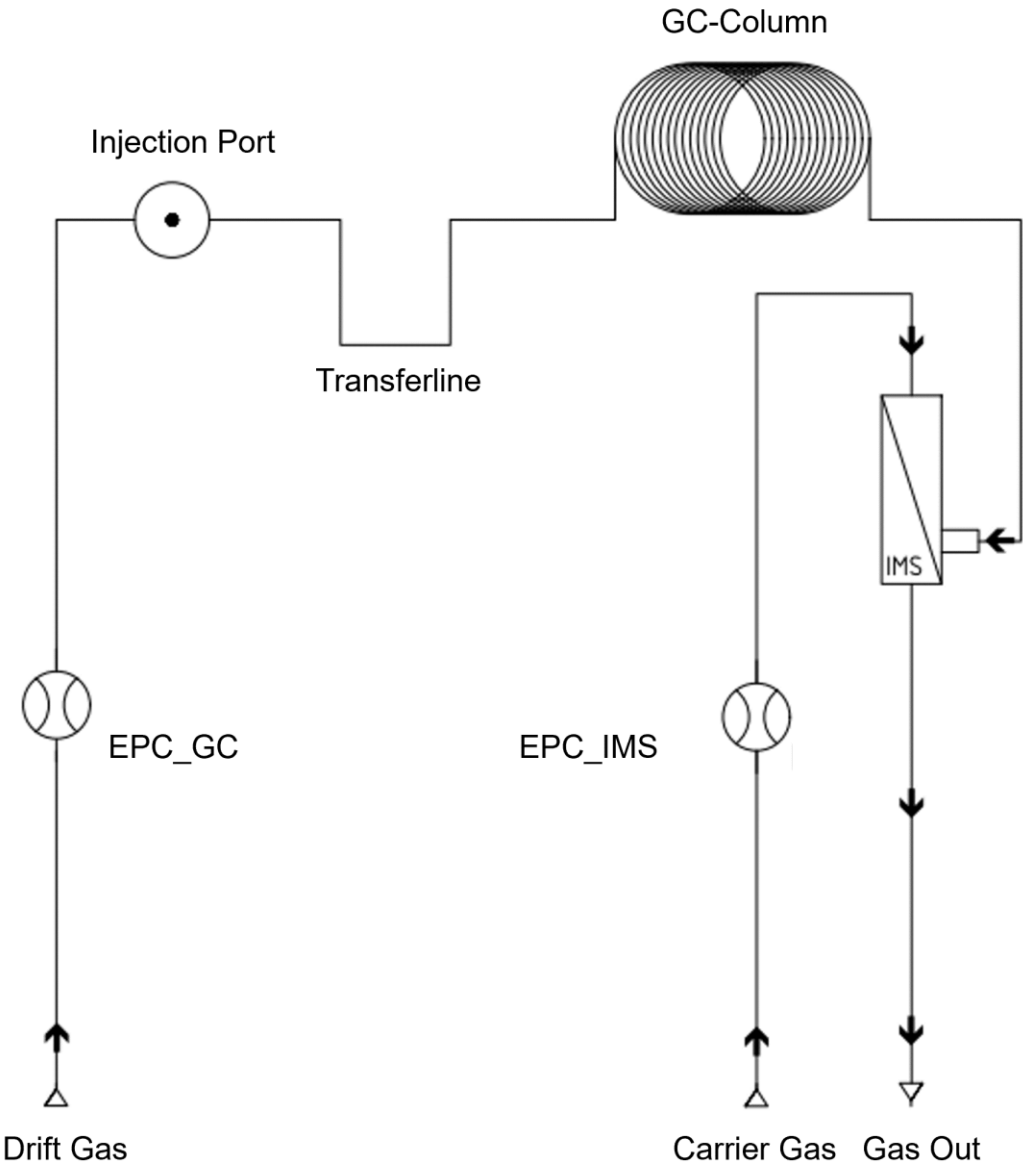

9.6 PAL LED Status LED



INFORMATION!
For detailed information refer the CTC PAL RSI User Manual

LED Color	LED Status	Specification
Successful Booting Process		
● Off	Off	Off
● Yellow	Blinking fast	PALsystems booting
● Blue	Blinking fast	Updating Software
● Yellow	Blinking normal	Application software initialized
● Green	Blinking normal	Application working
● Green	Steady ON	Application Ready
● Yellow	Steady ON	Booting Process Errors
LED Status during Operation		
● Yellow	Blinking normal	Configuration error
● Yellow	Steady ON	Activity execution error
● Blue	Blinking normal	Backup / Restore executed
● Blue	Steady ON	Manual operation (waiting for inputs)
● Green	Blinking normal	PALsystem working
● Green	Steady ON	PALsystem Ready / Idle
● Yellow	Steady ON	Fatal error

9.7 LED Status at PAL Control PCB



INFORMATION!

For detailed information refer the CTC PAL RSI User Manual

LED Color	LED Status	Specification
Successful Booting Process		
● Off	Off	Off
● Red	Steady ON	PALsystems booting
● Red	Blinking fast	Software OS Initialized
● Green	Blinking normal	Application software initialized
● Green	Steady ON	PALsystem Ready

9.8 FlavourSpec® Defaults – Parameter

Parameter	G.A.S. Standardvalue	Range
EPC_IMS	75 ml/min	Off; 1 ml/min – 500 ml/min
EPC_GC	5 ml/min	Off; 1 ml/min – 150 ml/min
T1	45°C	Off; 5°C – 80°C
T2	40°C	Off; 5°C – 80°C
T3	80°C	Off; 5°C – 80°C
T4	80°C	Off; 5°C – 80°C
T5	45°C	Off; 5°C – 80°C
T6	off	Off; 5°C – 80°C
Averaging	6	Off; 1 - 99
Trigger-D.	100 µs	10 µs – 2000 µs

9.9 FlavourSpec® Program parameter

Parameter	G.A.S. Standardvalue	Range
Time	---	00 min 00 sec 000 ms – 59 min 59 sec 980 ms
E1	75 ml/min	0 ml/min – 500 ml/min
E2	5 ml/min	0 ml/min – 150 ml/min
R	---	rec ● / stop ■

9.10 PAL RSI Headspace Methods parameter

Parameter	G.A.S. Standardvalue	range
Agitator	Agitator 1	None; Agitator 1
AgitatorSpeed	500 rpm	60 rpm – 750 rpm
AgitatorStandbyTemp	60.0°C	30.0°C – 200.0°C
FillingStrokesCount	0	0 – 15
FillingStrokesVolume	1.0 mL	0 – 2.2 mL
GasChromatograph	GC1	None; GC1
IncubationTemperatures	60.0°C	30.0°C – 200.0°C
IncubationTime	20.0 min	0.1 min – 600.0 min
InjectionFlowRate	51.0 mL/min	1.0 mL/min – 100.0 mL/min
InjectionSignalMode	PlungerUp	PreInject; PlungerUp
Injection	Injector 1	None; Injector 1
InjectionPenetrationDepth	35.0 mm	15.0 mm – 50.0 mm
PostInjectionDwellTime	0.5 s	0.0 s – 60.0 s
PostInjectionPurgeTime	10.0 s	0.0 s – 600.0 s
PreInjectionDwellTime	0.5 s	0.0 s – 60.0 s

FlavourSpec®25– User Manual

PerInjectionPurgeTime	5.0 s	0.0 s – 60.0 s
SampleVialDepth	15.0 mm	10.0 mm – 50.0 mm
Syringe	HS 1	None; HS 1
SyringeTemperatures	80.0°C	40.0°C – 150.0°C



INFORMATION!

- Teach the Injector Position after every tool change.
- The Injection Penetration Depth Value must be 35.0 mm. Do not modify.

9.11 PAL RSI ITEX Methods parameter

Parameter	G.A.S. Standardvalue	range
ITEX Tool	ITEX 1	None; ITEX 1
Analysis Time	21.5 min	0.0 min – 600.0 min
Sync Before Incubation End	0.0 min	0.0 min – 600.0 min
GasChromatograph	GC1	None; GC1
Trap Pre Cleaning Temp	320°C	100°C – 350°C
Trap Pre Cleaning Time	200.0 s	0.0 s – 86400 s
IncubationTime	20.0 min	0.1 min – 600.0 min
IncubationTemp	60°C	30.0°C – 200.0°C
Agitator	Agitator 1	None; Agitator 1
Heat Agitator	X	X; <input type="checkbox"/>
Wait for Readiness Agitator	X	X; <input type="checkbox"/>
AgitatorSpeed	500 rpm	60 rpm – 750 rpm
Extraction Strokes	50	0 - 1000

FlavourSpec® 25 - User Manual

Trap Extraction Temp	40°C	30.0°C – 150.0°C
Syringe Temp	80°C	40.0 °C – 150.0°C
AgitatorStandbyTemp	60.0°C	30.0 °C – 200.0°C
Wait for Readiness Syringe	X	X; <input type="checkbox"/>
Extraction Volume	1000.0	0.0 ml – 1300 ml
Extraction Aspirate Flow Rate	15.0 ul/s	10.0 ul/s – 1000.0 ul/s
Extraction Dispense Flow Rate	200.0 ul/s	10.0 ul/s – 1000.0 ul/s
Sample Refill Ratio	10.0 %	-
Vial Penetration Depth	12.0 mm	10.0 mm – 35.0 mm
Water Removal	Disabled	Disabled; Enabled
Water Removal Trap Temp	90.0°C	40.0°C – 150.0°C
Water Removal Purge	300.0 s	0.0 s – 600.0 s
Water Removal Position	None	-
Desorb Temp	300°C	50.0°C – 350°C
Injection	Injector 1	None; Injector 1
InjectionAspirate Flow	10.0 mL/s	1,0 mL/s – 1000,0 mL/s
Post Inject Delay	5.0 s	0.0 s – 600.0 s
Desorb Flow Rate	100,0 ul/s	5,0 ul/s – 1000,0 ul/s
Injection Penetration Depth	35.0 mm	10.0 mm – 35.0 mm
Injection Penetration Speed	50.0 mm/s	1.0 mm/s – 100.0 mm/s
Injection Signal Mode	Plunger Up	Pre Inject; Plunger Up; Plunger Down
Trap Post Cleaning Time	300.0 s	0.0 s – 86400.0 s
Trap Post Cleaning Temp	320.0°C	100.0°C – 350.0 s



INFORMATION!

- Teach the Injector Position after every tool change.
- The Injection Penetration Depth Value must be 35 mm. Do not modify.

9.12 PAL RSI Job parameter

Parameter	G.A.S. Standardvalue	Range
First Sample Index	1	1 - 60
Last Sample Index	60	1 - 384
SampleRack	Rack1	None; Rack1
SampleVolume	0.3 mL	0.0 mL – 5.0 mL



INFORMATION!

- The Injection Penetration Depth Value must be 35.0 mm. Do not modify. The values for First Sample Index, Last Sample Index and SampleVolume must be set by the user.
- Set the Parameter SampleRack to Rack1.

9.13 Troubleshooting

9.13.1 Error message list

Error message	Drift voltage supply.
<i>Description</i>	<i>Drift voltage error</i>
Action	Fatal Error! Contact the G.A.S. service hotline.
Error message	Can't save measurement.

<i>Description</i>	<i>The measurement file could not be saved to the internal memory.</i>
Action	Export and save all Measurement of the internal storage and clear the storage. Repeat the procedure. If that still does not help contact the G.A.S. service hotline.
Error message	smb connection failed:
<i>Description</i>	<i>Samba (Service Message Block SMB) connection failed.</i>
Action	Check network cable, network shares and IP-address. Repeat the procedure. If that still does not help contact the G.A.S. service hotline.
Error message	sftp connection failed:
<i>Description</i>	<i>Secure File Transfer Protocol (SFTP) connection failed.</i>
Action	Check network cable, network shares and IP-address. Repeat the procedure. If that still does not help contact the G.A.S. service hotline.
Error message	No USB-Storage found.
<i>Description</i>	<i>Mounting of the USB-Stick failed.</i>
Action	Ensure that a USB-Stick is insert. Ensure that the USB-Stick is FAT32 formatted. Reformat the USB-Stick. Replace the USB-Stick with a new one. If that still does not help contact the G.A.S. service hotline.
Error message	Unable to unmount USB-Storage.
<i>Description</i>	<i>Unmounting of the USB-Stick failed.</i>
Action	Remove the USB-Stick and restart the device. Check the USB-Stick, optionally reformat it. Insert the USB-Stick and repeat the

FlavourSpec®25– User Manual

	procedure. If that still does not help contact the G.A.S. service hotline.
Error message	No program selected.
<i>Description</i>	<i>At program start no program was detected</i>
Action	Create and select a program. Repeat the procedure. If that still does not help contact the G.A.S. service hotline.
Error message	Drift gas flow too low. Aborting...
<i>Description</i>	<i>At program start the drift gas flow is too low. Programstart will be refused.</i>
Action	Increase the back pressure. Repeat the procedure. If that still does not help contact the G.A.S. service hotline.
Error message	Stop recording first.
<i>Description</i>	<i>If recording is activ a programstart is refused.</i>
Action	Deactivate recording and repeat the procedure. If that still does not help contact the G.A.S. service hotline.
Error message	Can't initialize drift supply. Program can not be started.
<i>Description</i>	<i>Drift voltage error</i>
Action	Fatal Error! Contact the G.A.S. service hotline.
Error message	Invalid program.
<i>Description</i>	<i>The selected program has no instructions.</i>
Action	Complete the program and repeat the procedure. If that still does not help contact the G.A.S. service hotline.
Error message	Not enough storage space left. Please delete or copy measurement or choose a shorter program.

<i>Description</i>	<i>The internal storage has not enough storage space left.</i>
Action	Export and save all Measurement of the internal storage and clear the storage. Repeat the procedure. If that still does not help contact the G.A.S. service hotline.
Error message	Hardware access failure
<i>Description</i>	<i>Error when switching the drift voltage polarity.</i>
Action	Fatal Error! Contact the G.A.S. service hotline.
Error message	Valve set to Inject. Loop not filled! Proceed? OK or Chancel
<i>Description</i>	<i>Valve start position is set to Inject instead of Fill loop.</i>
Action	Set valve start position manually to Fill loop. Repeat the procedure. If that still does not help contact the G.A.S. service hotline.
Error message	Can't import calibration.gsd
<i>Description</i>	<i>The file „calibration.gsd“ was not found.</i>
Action	Create the file „calibration.gsd“ and import it with an USB-Stick. Repeat the procedure. If that still does not help contact the G.A.S. service hotline.
Error message	No measurements stored.
<i>Description</i>	<i>No measurements stored on the internal storage.</i>
Action	Do a measurement. Repeat the procedure. If that still does not help contact the G.A.S. service hotline.
Error message	Folder cannot be created :
<i>Description</i>	<i>When exporting the device subfolder could not be created.</i>

FlavourSpec®25– User Manual







Action	Check the external storage. Check network cable, network shares and IP-address. Check write protection of the USB-Stick. Ensure that the USB-Stick is FAT32 formatted. Reformat the USB-Stick. Replace the USB-Stick with a new one. Repeat the procedure. If that still does not help contact the G.A.S. service hotline.
Error message	No measurement files transferred
<i>Description</i>	<i>No measurement are transferred to an external storage.</i>
Action	Check the external storage. Check network cable, network shares and IP-address. Check write protection of the USB-Stick. Ensure that the USB-Stick is FAT32 formatted. Reformat the USB-Stick. Replace the USB-Stick with a new one. Repeat the procedure. If that still does not help contact the G.A.S. service hotline.
Error message	No measurements stored.
<i>Description</i>	<i>No measurements were deleted, because no measurements are available.</i>
Action	Do a measurement. Repeat the procedure. If that still does not help contact the G.A.S. service hotline.
Error message	RTC read error.
<i>Description</i>	<i>Date and time setting failed.</i>
Action	Restart the system and repeat the procedure. If that still does not help contact the G.A.S. service hotline.
Error message	Save settings failed.

<i>Description</i>	<i>Setting data could not be save on a USB-stick.</i>
Action	Check write protection of the USB-Stick. Ensure that the USB-Stick is FAT32 formatted. Reformat the USB-Stick. Replace the USB-Stick with a new one. Repeat the procedure. If that still does not help contact the G.A.S. service hotline.
Error message	Load settings failed.
<i>Description</i>	<i>Setting data could not be load from a USB-stick</i>
Action	Repeat the procedure. Restart the system and repeat the procedure. Check write protection of the USB-Stick. Ensure that the USB-Stick is FAT32 formatted. Reformat the USB-Stick. Replace the USB-Stick with a new one. Repeat the procedure. If that still does not help contact the G.A.S. service hotline.
Error message	Do you really want to relabel loop volume? It will be stored in all following measurements.
<i>Description</i>	<i>Sample loop setting is change manually.</i>
Action	Confirm or abort the dialog.
Error message	Can't set static ip!
<i>Description</i>	<i>Setup of the static IP-address failed.</i>
Action	Check the network settings. Contact your administrator. Repeat the procedure. If that still does not help contact the G.A.S. service hotline.
Error message	Can't request DHCP:
<i>Description</i>	<i>Setup of the dynmaic IP-address failed.</i>
Action	Check the network settings. Check DHCP-server. Contact your administrator. Repeat the



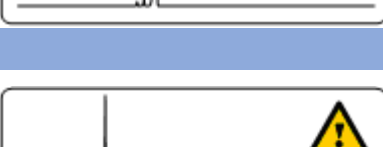

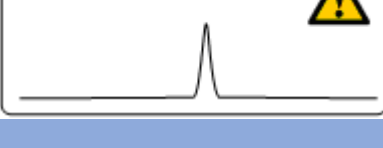
	procedure. If that still does not help contact the G.A.S. service hotline.
Error message	Valve set to Inject. Loop not filled
<i>Description</i>	<i>Valve setting is set to position “Inject” and not to “Fill loop”. Sample loop could not be filled.</i>
Action	Abort program and set valve to position „Fill loop“ manually.
Error message	Trigger recieved while running program.
<i>Description</i>	<i>During the program run a new trigger signal will be received. The program run is aborted.</i>
Action	The device get a wrong trigger signal. Check the external trigger programming. Repeat the procedure. If that still does not help contact the G.A.S. service hotline.
Error message	Stop recording first.
<i>Description</i>	<i>When starting the trigger mode recording is activated.</i>
Action	Deactivate recording and repeat the procedure. If that still does not help contact the G.A.S. service hotline.
Error message	Select program first.
<i>Description</i>	<i>When starting the trigger mode no program is activated.</i>
Action	Select a program and repeat the procedure. If that still does not help contact the G.A.S. service hotline.
Error message	Can't read calibration.gsd
<i>Description</i>	<i>The import of the calibration.gsd. file failed. The file was not found.</i>
Action	Ensure that the file calibration.gsd exist and is placed in the measurement subfolder of

the device. Check network cable, network shares and IP-address.
Repeat the procedure. If that still does not help contact the G.A.S. service hotline.

9.13.2 IMS-Spectrum Examples

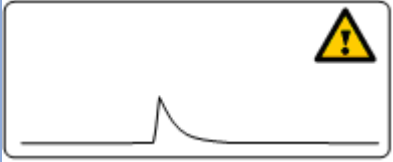
Schematic of IMS spectrum	Spectrum description	reasons / suggestions
	Clean spectrum	Perfect
	Clean spectrum, up to two extra signals left hand side of the RIP	Perfect
	RIP shifted to lower drift times	<ul style="list-style-type: none"> - elevated temperature - reduced pressure
	RIP shifted to higher drift times	<ul style="list-style-type: none"> - low temperatures - elevated pressure
	RIP deformed	<ul style="list-style-type: none"> - gas quality out of specifications - device needs to be flushed for some time - flows not in range
	RIP base deformed yet visible	<ul style="list-style-type: none"> - gas quality out of specifications - device needs to be flushed for some time - flows not in range

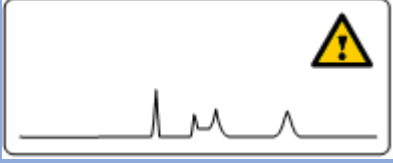
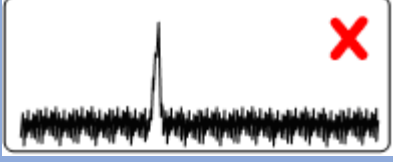
FlavourSpec®25– User Manual

	RIP deformed towards tailing	<ul style="list-style-type: none"> - gas quality out of specifications - device needs to be flushed for some time - flows not in range
	Minor impurities	<ul style="list-style-type: none"> - gas quality out of specifications - device is polluted > run system cleaning
	Major impurities	<ul style="list-style-type: none"> - gas quality out of specifications - device is polluted > run system cleaning
	Elevated noise	Contact G.A.S. support
	No signal	Contact G.A.S. support

9.13.3 Troubleshooting / How to...



INFORMATION!

This chapter is a collection of possible practical problems and serves as a guide for making an initial assessment. It makes no claim to completeness.

Symptom

Device does not start

Possible Cause

Problem with the electrical power supply

Action	Check the current power supply and restart the system. If that still does not help contact the G.A.S. service hotline.
Symtom	Device freezes during start procedure.
<i>Possible Cause</i>	<i>Problem with the Firmware</i>
Action	Restart the system. If that still does not help contact the G.A.S. service hotline.
Symtom	Start procedure paused
<i>Possible Cause</i>	<i>Hardwarecheck during the start procedure</i>
Action	Wait up to 5 min. Normally the start procedure continues. Restart the system. If that still does not help contact the G.A.S. service hotline.
Symtom	Temperature and/or gas flow values will not be displayed
<i>Possible Cause</i>	<i>Problem with hardware/firmware communication</i>
Action	Restart the system. If that still does not help contact the G.A.S. service hotline.
Symtom	Screen is black while device is on.
<i>Possible Cause</i>	<i>Screensaver is active</i>
Action	Using the pushable rotary knob to active the screen. If the screen can't be reactivated then restart the system. If that still does not help contact the G.A.S. service hotline.
Symtom	Gasflow set-values cannot be achieved.
<i>Possible Cause</i>	<i>Backpressure to low</i>
Action	Set up the back pressure at least to 3-6 bar (recommended 5 bar!). If that still does not help contact the G.A.S. service hotline.

FlavourSpec®25– User Manual

<i>Possible Cause</i>	<i>Hardware failure</i>
Action	Contact the G.A.S. service hotline.
Symtom	Temperature set-values cannot be achieved.
<i>Possible Cause</i>	<i>Hardware failure</i>
Action	Contact the G.A.S. service hotline.
Symtom	No display of measurement values during monitoring
<i>Possible Cause</i>	<i>Hardware failure</i>
Action	Contact the G.A.S. service hotline.
Symtom	No Reaction Ion Peak (RIP) will be displayed.
<i>Possible Cause</i>	<i>Device is in negative mode</i>
Action	Switch the drift voltage into positive mode. If that still does not help contact the G.A.S. service hotline.
<i>Possible Cause</i>	<i>Hardware failure</i>
Action	Contact the G.A.S. service hotline.
Symtom	No or small Reaction Ion Peak (RIP) will be displayed.
<i>Possible Cause</i>	<i>Insufficient gas quality</i>
Action	Check quality of operating gas (5.0 or better) and use moisture trap.
Action	When using the CGFU-unit, replace the CGFU-filters.
<i>Possible Cause</i>	<i>System contamination</i>
Action	Start cleaning mode.
Symtom	Find signals from the prior measurement run in the chromatogram
<i>Possible Cause</i>	<i>The measurement runtime is too short.</i>
Action	Increase the measurement run time

Symtom	The actual size of the measurement file is to large
<i>Possible Cause</i>	<i>Average setting too low.</i>
Action	Increase the Average setting or shorten the runtime (recommended averaging: 6).
Symtom	The measurement signals cannot mapped well.
<i>Possible Cause</i>	<i>Average setting is too high.</i>
Action	Decrease the Average setting (recommended averaging: 6).
Symtom	EPC_GC Maximum flow of 150 ml/min is not reached.
<i>Possible Cause</i>	<i>The reachable maximum flow depends on the dimensions of the installed column.</i>
Action	Get the specified maximum flow from Analytical approval. If that still does not help contact the G.A.S. service hotline.
<i>Possible Cause</i>	When using a CGFU unit the total flow (EPC_IMS and EPC_GC) is limited to 400 ml/min.
Action	No Action
Symtom	Six-Port-valve doesn't switch
<i>Possible Cause</i>	<i>Lost connection</i>
Action	Restart the system. If that still does not help contact the G.A.S. service hotline.
Symtom	Six-Port-valve switching noise sounds strange
<i>Possible Cause</i>	<i>Initialization lost</i>
Action	Reintializise the Six-Port-Valve
Symtom	No sample signals are displayed during a measurement.
<i>Possible Cause</i>	<i>Sample-Pump has failed</i>

FlavourSpec®25– User Manual

Action	Set pump capacity to 100%. The pump device must be audible loud. Turn the pumping power back to the working flow. In addition, the flow can be measured using a flowmeter at the sample inlet and outlet. If that still does not help change sample pump.
--------	---

Symptom	Drift time fluctuates
----------------	------------------------------

<i>Possible Cause</i>	<i>System is untight</i>
-----------------------	--------------------------

Action	Check all gas supply connections of operating gas.
--------	--

Action	Check all gas supply connections of GC-column.
--------	--

Symptom	Retention time fluctuates
----------------	----------------------------------

<i>Possible Cause</i>	<i>System is untight</i>
-----------------------	--------------------------

Action	Check all gas supply connections of operating gas.
--------	--

Action	Check all gas supply connections of GC-column.
--------	--

9.14 Consumables / Spare Parts



Part number: 100001817

Power supply with Power plug



Gas tube Kit: (FlavourSpec®)

Drift gas/carrier gas adapter consisting of
Cross screw fitting 100000939

Tube piece 100000937

Part number: 100001102

2 m 3 mm PFA Tubes with 3 mm Swagelok-
Connector

Part number: 100001110

0.15 m 3 mm PFA Tubes with 3 mm
Swagelok-Connector

Part number: 100001104

0.60 m 3 mm PFA Tubes with 3 mm
Swagelok-Connector



Part number: 100001094

Molecular sieve 200 mL with 1/8"
connections

(Labuse)



Part number: 100001998

Molecular sieve 120 mL with 1/8" connections

(Attachable to device)

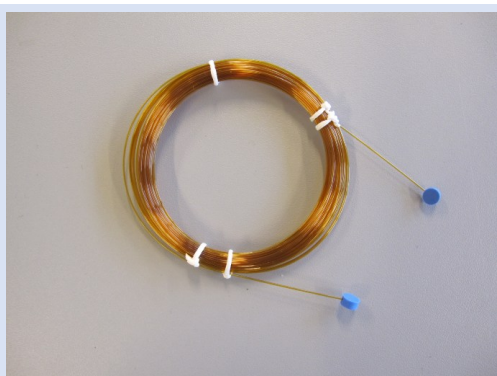

Part number: 100001898

Standard-capillary column MXT-5
Length 15 m, ID 0.53 mm, Filmthickness 1 µm, Winding ID 80 mm

(Other column types only on request)

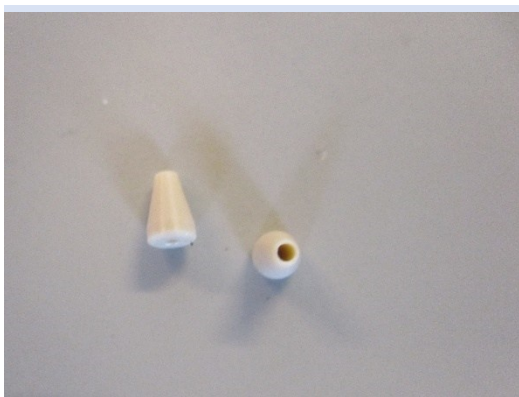

Part number: 100001170

Peek Ferrules for capillary column with ID 0.53 mm
Connection 1/16", Hole 0.8 mm



Part number: Part number: 100002090

LAN Cable



Part number: 10000934

Blind plug Set



Part number: 10002003

Custom Ketones Standard



Part number: 10001216

Torx Tool Kit

- Torx screwdriver 8 mm
- Torx screwdriver 10 mm



Part number: 10001873

FlavourSpec® Transport box Length = 110 cm, Height = 80 cm, Width = 77 cm

FlavourSpec®25– User Manual

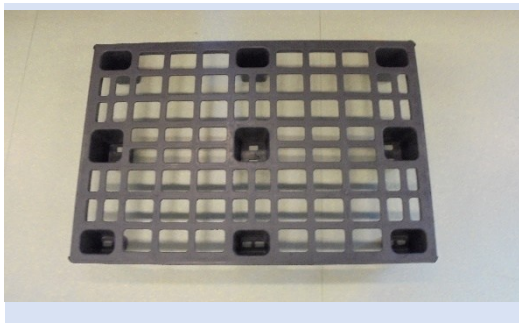

Part number: 100002764

FlavourSpec® Transport palett (120 x 80 cm)



Part number: 100001516

FlavourSpec®-PAL3 Connection Cable



Part number: 100001939

1000 µL Smart Headspace Syringe with fixed
needle for Tool HS1000 (PAL3 RSI SII)



Part number: 100001957

Nitrogen Generator with accessories
(example picture)

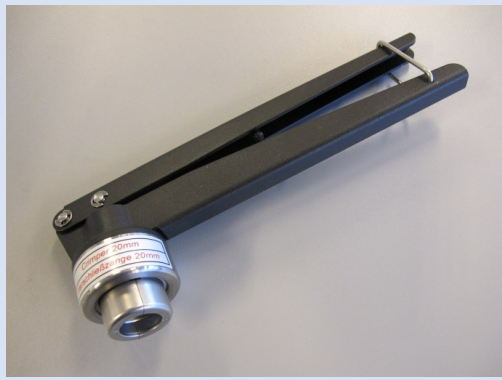

Part number: 100001988
Crimper for 20 mL Headspace Vials



Part number: 10001989
Septa BTO, Silicon red, 3 mm size, 11 mm Ø
Package size: 25 pieces



Part number: 100002581
Headspace vials, glas 1. hydrolyt. class DIN ISO 719
Volume: 20 mL, Beading Ø x Height: 20 x 3,6 mm, Vial height x OD: 75,5 x 22,5 mm
Package size: 100 pieces



Part number: 100001984
Magnetic Cap Aluminium, Hole-Ø 7 mm
gasket Silica, PTFE 3 mm, for beading 20 x 3.6 mm
Package size: 100 pieces

FlavourSpec®25– User Manual



Part number: 100001946

PAL ITEX-Kit



Part number: 100001940

Smart ITEX Syringe 1300 µL for Tool ITEX
(PAL3 RSI SII)



Part number: 100001941

ITEX-2 Trap (G23) Siliconert 2000 Tenax TA
80/100



Part number: 100002131

Laptop Computer (different design) including
software for control and evaluation

9.15 G.A.S. Documents and Tutorials



INFORMATION!

- FlavourSpec® Quickstart Manual
- PAL3 System User Manual
- Sequence Designer Manual
- IMS Control TFTP-Server Manual
- Tutorials Sequence Designer
- Tutorials VOCal
- Manuals VOCal
- PAL Control Manual

9.16 Table of Figures

Figure 1: Ion Mobility Spectrometer - Basic Relations	22
Figure 2: Ion Mobility Spectrometer -Working Principle	23
Figure 3: IMS Predominant Ionization (positive polarization).....	24
Figure 4: Protone Affinities of VOC's	24
Figure 5: GC-IMS measurement 3D	25
Figure 6: Schematic of the sample- and drift gas flow paths	26
Figure 7: Chromatograms of 2-ketones (C 4-9) for varying drift gas flows	27
Figure 8: GC-IMS device plan (exemplary).....	29
Figure 9: FlavourSpec® - Housing of device - Front.....	31
Figure 10: FlavourSpec® - Housing of device - Rear	32
Figure 11: Device Type / Serial Number Plate.....	33
Figure 12: Operating Interface - Overview.....	35
Figure 13: Operating Interface - Windows Selection Bar	36
Figure 14: Operating Interface - Status Bar	37
Figure 15: Operating Interface – View Control Bar	38
Figure 16: Operating Interface - Low Pressure Alarm Box	39
Figure 17: Operating Interface - High Pressure Alarm Box	39
Figure 18: Operating Interface - Spectra Window.....	40
Figure 19: Start Program	42
Figure 20: Recording Check Box.....	43
Figure 21: Recording Check Box.....	43
Figure 22: Trigger Mode Window	44
Figure 23: Choose source for samplenames 1	45
Figure 24: Choose source for samplenames 2	46
Figure 25: Choose source for samplenames 3	46
Figure 26: Sample Names List	47
Figure 27: Operating Interface - Sequence Window.....	48
Figure 28: Operating Interface - Sequence Window - Processing	49
Figure 29: Operating Interface - Defaults Window.....	50
Figure 30: Drift Voltage Windows - positive and negative Mode.....	52
Figure 31: Flow Control (Example)	52
Figure 32: Temperature Control (Example)	52
Figure 33: Operating Interface - Programs Window	53
Figure 34: Measurement Control Panel	54
Figure 35: Selected Program Window	56
Figure 36: Program Action Control Panel	57
Figure 37: Program Action Editor	58
Figure 38: Program Action View	59
Figure 39: Flow Ramps	60
Figure 40: Operating Interface - System Window	62
Figure 41: Operating Interface - System Info Window	63
Figure 42: Operating Interface - System Plan Window	64
Figure 43: Operating Interface - System Settings Windows 1	65
Figure 44: Operating Interface - System Settings Window 2	66
Figure 45: Operating Interface - System Settings Windows 3	68
Figure 46: Operating Interface – Snapshot Window	70
Figure 47: Operating Interface – Snapshot Window in detail (example EPC_GC pressure)	71
Figure 48: Operating Interface – Column Data Editor Window	73

Figure 49: Column Preset Window	74
Figure 50: EPC Settings Window	75
Figure 51: Operating Interface - Simplified View Window.....	76
Figure 52: Operating Interface - System Transfer Window.....	77
Figure 53: Operating Interface - System Transfer Window.....	79
Figure 54: Operating Interface - System Modes Window	81
Figure 55: Operating Interface - Trigger Mode Window.....	82
Figure 56: Operating Interface - Remote Mode Window	83
Figure 57: Operating Interface - Cleaning Mode Window.....	84
Figure 58: Operating Interface - Standby Mode Window.....	85
Figure 59: Error Information Window.....	86
Figure 60: Log Messages Dialog Window	87
Figure 61: IP Adress Input Dialog Windows	88
Figure 62: Date and Time Input Dialog Window	89
Figure 63: Text Input Dialog Window.....	90
Figure 64: Number Input Dialog Window (Example).....	91
Figure 65: Autosampler Terminal	92
Figure 66: PAL Control Software	93
Figure 67: Space requirement FlavourSpec® with Autosampler PAL RSI	95
Figure 68: Gas supply installation (schematic).....	107